

# SURB1610CT thru SURB1620CT

## Ultra Fast Recovery Epitaxial Diodes

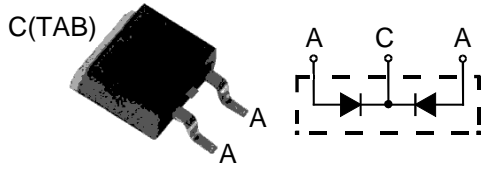

A=Anode, C(TAB)=Cathode

Dimensions TO-263(D<sup>2</sup>PAK)

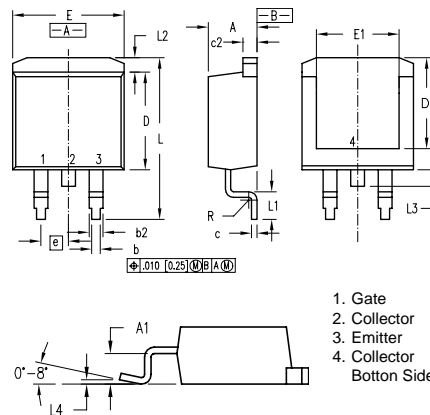

Dim.	Millimeter		Inches	
	Min.	Max.	Min.	Max.
A	4.06	4.83	.160	.190
A1	2.03	2.79	.080	.110
b	0.51	0.99	.020	.039
b2	1.14	1.40	.045	.055
c	0.46	0.74	.018	.029
c2	1.14	1.40	.045	.055
D	8.64	9.65	.340	.380
D1	8.00	8.89	.315	.350
E	9.65	10.29	.380	.405
E1	6.22	8.13	.245	.320
e	2.54 BSC		.100 BSC	
L	14.61	15.88	.575	.625
L1	2.29	2.79	.090	.110
L2	1.02	1.40	.040	.055
L3	1.27	1.78	.050	.070
L4	0	0.20	0	.008
R	0.46	0.74	.018	.029

	V <sub>RSM</sub>	V <sub>RRM</sub>
	V	V
<b>SURB1610CT</b>	100	100
<b>SURB1620CT</b>	200	200

1. Gate
2. Collector
3. Emitter
4. Collector Bottom Side

Symbol	Test Conditions	Maximum Ratings	Unit
<b>I<sub>FRMS</sub></b>	T <sub>VJ</sub> =T <sub>VJM</sub>	16	A
<b>I<sub>FAVM</sub></b>	T <sub>C</sub> =115°C; rectangular, d=0.5	8	
<b>I<sub>FRM</sub></b>	t <sub>p</sub> <10us; rep. rating, pulse width limited by T <sub>VJM</sub>	130	
<b>I<sub>FSM</sub></b>	T <sub>VJ</sub> =45°C	t=10ms (50Hz), sine t=8.3ms (60Hz), sine	A
	T <sub>VJ</sub> =150°C	t=10ms(50Hz), sine t=8.3ms(60Hz), sine	
<b>I<sup>2</sup>t</b>	T <sub>VJ</sub> =45°C	t=10ms (50Hz), sine t=8.3ms (60Hz), sine	A <sup>2</sup> s
	T <sub>VJ</sub> =150°C	t=10ms(50Hz), sine t=8.3ms(60Hz), sine	
<b>T<sub>VJ</sub></b> <b>T<sub>VJM</sub></b> <b>T<sub>stg</sub></b>		-40...+150 150 -40...+150	°C
<b>P<sub>tot</sub></b>	T <sub>C</sub> =25°C	50	W
<b>M<sub>d</sub></b>	Mounting torque	0.4...0.6	Nm
<b>Weight</b>		2	g

# SURB1610CT thru SURB1620CT

## Ultra Fast Recovery Epitaxial Diodes

Symbol	Test Conditions	Characteristic Values		Unit
		typ.	max.	
<b>I<sub>R</sub></b>	$T_{VJ}=25^{\circ}\text{C}; V_R=V_{RRM}$		20	uA
	$T_{VJ}=25^{\circ}\text{C}; V_R=0.8 \cdot V_{RRM}$		10	uA
	$T_{VJ}=125^{\circ}\text{C}; V_R=0.8 \cdot V_{RRM}$		1.5	mA
<b>V<sub>F</sub></b>	$I_F=8\text{A}; T_{VJ}=150^{\circ}\text{C}$		1.3	V
	$T_{VJ}=25^{\circ}\text{C}$		1.5	
<b>V<sub>TO</sub></b>	For power-loss calculations only		0.98	V
<b>r<sub>T</sub></b>	$T_{VJ}=T_{VJM}$		28.7	mΩ
<b>R<sub>thJC</sub></b> <b>R<sub>thCK</sub></b> <b>R<sub>thJA</sub></b>		0.5	2.5	K/W
			60	
<b>t<sub>rr</sub></b>	$I_F=1\text{A}; -di/dt=50\text{A/us}; V_R=30\text{V}; T_{VJ}=25^{\circ}\text{C}$	35	50	ns
<b>I<sub>RM</sub></b>	$V_R=540\text{V}; I_F=15\text{A}; -di_F/dt=100\text{A/us}; L<0.05\mu\text{H}; T_{VJ}=100^{\circ}\text{C}$	2.5	2.8	A

### FEATURES

- \* International standard package JEDEC TO-263
- \* Planar passivated chips
- \* Very short recovery time
- \* Extremely low switching losses
- \* Low I<sub>RM</sub>-values
- \* Soft recovery behaviour

### APPLICATIONS

- \* Antiparallel diode for high frequency switching devices
- \* Antisaturation diode
- \* Snubber diode
- \* Free wheeling diode in converters and motor control circuits
- \* Rectifiers in switch mode power supplies (SMPS)
- \* Inductive heating and melting
- \* Uninterruptible power supplies (UPS)
- \* Ultrasonic cleaners and welders

### ADVANTAGES

- \* High reliability circuit operation
- \* Low voltage peaks for reduced protection circuits
- \* Low noise switching
- \* Low losses
- \* Operating at lower temperature or space saving by reduced cooling

# SURB1610CT thru SURB1620CT

## Ultra Fast Recovery Epitaxial Diodes

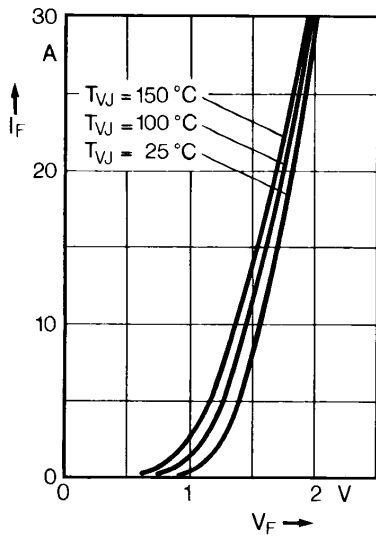

Fig. 1 Forward current versus voltage drop.

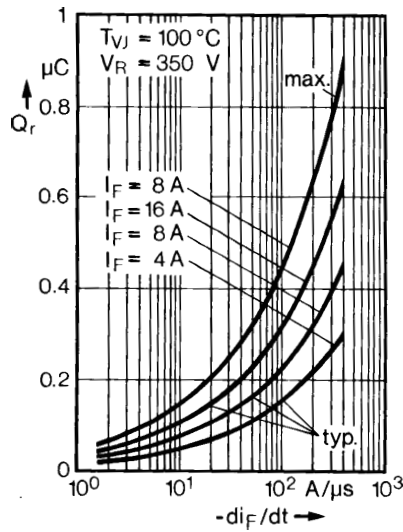

Fig. 2 Recovery charge versus  $-di_F/dt$ .

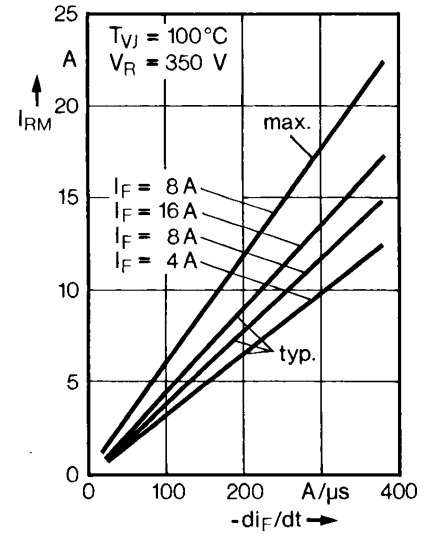

Fig. 3 Peak reverse current versus  $-di_F/dt$ .

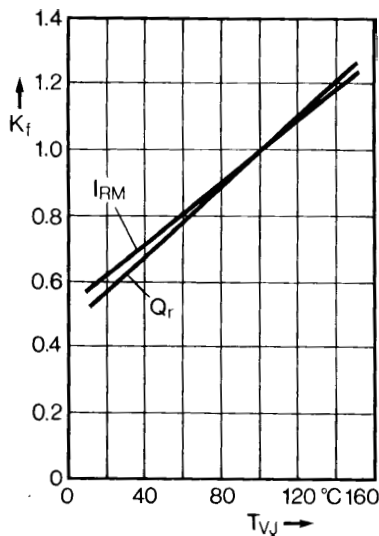

Fig. 4 Dynamic parameters versus junction temperature.

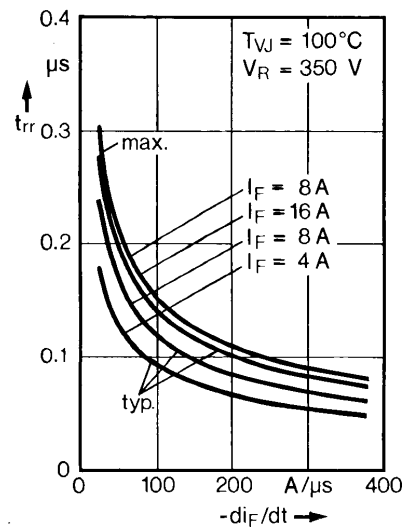

Fig. 5 Recovery time versus  $-di_F/dt$ .

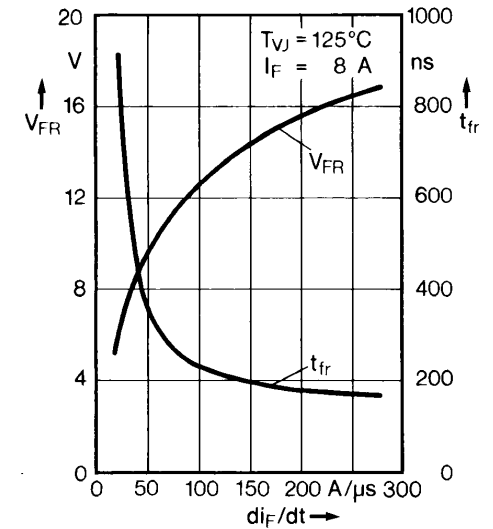

Fig. 6 Peak forward voltage versus  $di_F/dt$ .

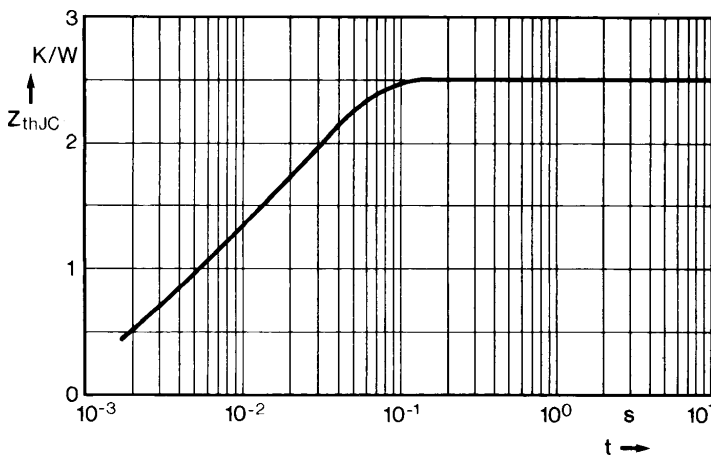

Fig. 7 Transient thermal impedance junction to case.