

RF Power Field Effect Transistors

N-Channel Enhancement-Mode Lateral MOSFETs

Designed for GSM and GSM EDGE base station applications with frequencies from 1800 to 2000 MHz. Suitable for TDMA, CDMA, and multicarrier amplifier applications.

GSM Application

- Typical GSM Performance: $V_{DD} = 26$ Vdc, $I_{DQ} = 600$ mA, $P_{out} = 60$ Watts CW, Full Frequency Band (1805-1880 MHz or 1930-1990 MHz)
Power Gain — 15 dB
Drain Efficiency - 50%

GSM EDGE Application

- Typical GSM EDGE Performance: $V_{DD} = 26$ Volts, $I_{DQ} = 450$ mA, $P_{out} = 25$ Watts Avg., Full Frequency Band (1805-1880 MHz or 1930-1990 MHz)
Power Gain — 15.5 dB
Spectral Regrowth @ 400 kHz Offset = -62 dBc
Spectral Regrowth @ 600 kHz Offset = -76 dBc
EVM — 2% rms
- Capable of Handling 5:1 VSWR, @ 26 Vdc, 1990 MHz, 60 Watts CW Output Power

Features

- Characterized with Series Equivalent Large-Signal Impedance Parameters
- Internally Matched for Ease of Use
- Qualified Up to a Maximum of 32 V_{DD} Operation
- Integrated ESD Protection
- 200°C Capable Plastic Package
- N Suffix Indicates Lead-Free Terminations. RoHS Compliant.
- In Tape and Reel. R1 Suffix = 500 Units per 44 mm, 13 inch Reel.

MRF6S18060NR1
MRF6S18060NBR1

1800-2000 MHz, 60 W, 26 V
GSM/GSM EDGE
LATERAL N-CHANNEL
RF POWER MOSFETs

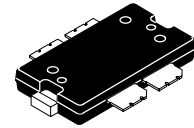

CASE 1486-03, STYLE 1
TO-270 WB-4
PLASTIC
MRF6S18060NR1

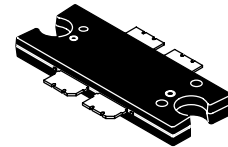

CASE 1484-04, STYLE 1
TO-272 WB-4
PLASTIC
MRF6S18060NBR1

Table 1. Maximum Ratings

Rating	Symbol	Value	Unit
Drain-Source Voltage	V_{DSS}	-0.5, +68	Vdc
Gate-Source Voltage	V_{GS}	-0.5, +12	Vdc
Total Device Dissipation @ $T_C = 25^\circ\text{C}$ Derate above 25°C	P_D	216 1.2	W W/°C
Storage Temperature Range	T_{stg}	- 65 to +175	°C
Operating Junction Temperature	T_J	200	°C

Table 2. Thermal Characteristics

Characteristic	Symbol	Value (1,2)	Unit
Thermal Resistance, Junction to Case Case Temperature 80°C, 60 W CW Case Temperature 77°C, 25 W CW	$R_{\theta JC}$	0.81 0.95	°C/W

1. MTTF calculator available at <http://www.freescale.com/rf>. Select Tools/Software/Application Software/Calculators to access the MTTF calculators by product.
2. Refer to AN1955, *Thermal Measurement Methodology of RF Power Amplifiers*. Go to <http://www.freescale.com/rf>. Select Documentation/Application Notes - AN1955.

Table 3. ESD Protection Characteristics

Test Methodology	Class
Human Body Model (per JESD22-A114)	1B (Minimum)
Machine Model (per EIA/JESD22-A115)	A (Minimum)
Charge Device Model (per JESD22-C101)	III (Minimum)

Table 4. Moisture Sensitivity Level

Test Methodology	Rating	Package Peak Temperature	Unit
Per JESD 22-A113, IPC/JEDEC J-STD-020	3	260	°C

Table 5. Electrical Characteristics ($T_C = 25^\circ\text{C}$ unless otherwise noted)

Characteristic	Symbol	Min	Typ	Max	Unit
----------------	--------	-----	-----	-----	------

Off Characteristics

Zero Gate Voltage Drain Leakage Current ($V_{DS} = 68\text{ Vdc}$, $V_{GS} = 0\text{ Vdc}$)	I_{DSS}	—	—	10	μAdc
Zero Gate Voltage Drain Leakage Current ($V_{DS} = 26\text{ Vdc}$, $V_{GS} = 0\text{ Vdc}$)	I_{DSS}	—	—	1	μAdc
Gate-Source Leakage Current ($V_{GS} = 5\text{ Vdc}$, $V_{DS} = 0\text{ Vdc}$)	I_{GSS}	—	—	1	μAdc

On Characteristics

Gate Threshold Voltage ($V_{DS} = 10\text{ Vdc}$, $I_D = 200\ \mu\text{Adc}$)	$V_{GS(th)}$	1	2	3	Vdc
Gate Quiescent Voltage ($V_{DS} = 26\text{ Vdc}$, $I_D = 600\ \text{mAdc}$)	$V_{GS(Q)}$	2	2.8	4	Vdc
Drain-Source On-Voltage ($V_{GS} = 10\text{ Vdc}$, $I_D = 2\ \text{Adc}$)	$V_{DS(on)}$	—	0.24	—	Vdc
Forward Transconductance ($V_{DS} = 10\text{ Vdc}$, $I_D = 2\ \text{Adc}$)	g_{fs}	—	5.3	—	S

Dynamic Characteristics

Reverse Transfer Capacitance (1) ($V_{DS} = 26\text{ Vdc} \pm 30\ \text{mV(rms)ac}$ @ 1 MHz, $V_{GS} = 0\text{ Vdc}$)	C_{rss}	—	1.5	—	pF
--	-----------	---	-----	---	----

Functional Tests (In Freescale Test Fixture, 50 ohm system) $V_{DD} = 26\text{ Vdc}$, $I_{DQ} = 600\ \text{mA}$, $P_{out} = 60\ \text{W CW}$, $f = 1930\ \text{MHz}$, $f = 1990\ \text{MHz}$

Power Gain	G_{ps}	14	15	17	dB
Drain Efficiency	η_D	48	50	—	%
Input Return Loss	IRL	—	-12	-9	dB
P_{out} @ 1 dB Compression Point	P1dB	60	65	—	W

1. Part is internally matched both on input and output.

(continued)

Table 5. Electrical Characteristics ($T_C = 25^\circ\text{C}$ unless otherwise noted) (continued)

Characteristic	Symbol	Min	Typ	Max	Unit
Typical GSM EDGE Performances (In Freescale Broadband Test Fixture, 50 ohm system) $V_{DD} = 26\text{ Vdc}$, $I_{DQ} = 450\text{ mA}$, $P_{out} = 25\text{ W Avg.}$, 1805-1880 MHz or 1930-1990 MHz, EDGE Modulation					
Power Gain	G_{ps}	—	15.5	—	dB
Drain Efficiency	η_D	—	32	—	%
Error Vector Magnitude	EVM	—	2	—	% rms
Spectral Regrowth at 400 kHz Offset	SR1	—	-62	—	dBc
Spectral Regrowth at 600 kHz Offset	SR2	—	-76	—	dBc

Typical CW Performances (In Freescale Broadband Test Fixture, 50 ohm system) $V_{DD} = 26\text{ Vdc}$, $I_{DQ} = 600\text{ mA}$, $P_{out} = 60\text{ W}$, 1805-1880 MHz or 1930-1990 MHz

Power Gain	G_{ps}	—	15	—	dB
Drain Efficiency	η_D	—	50	—	%
Input Return Loss	IRL	—	-12	—	dB
P_{out} @ 1 dB Compression Point, CW	P1dB	—	65	—	W

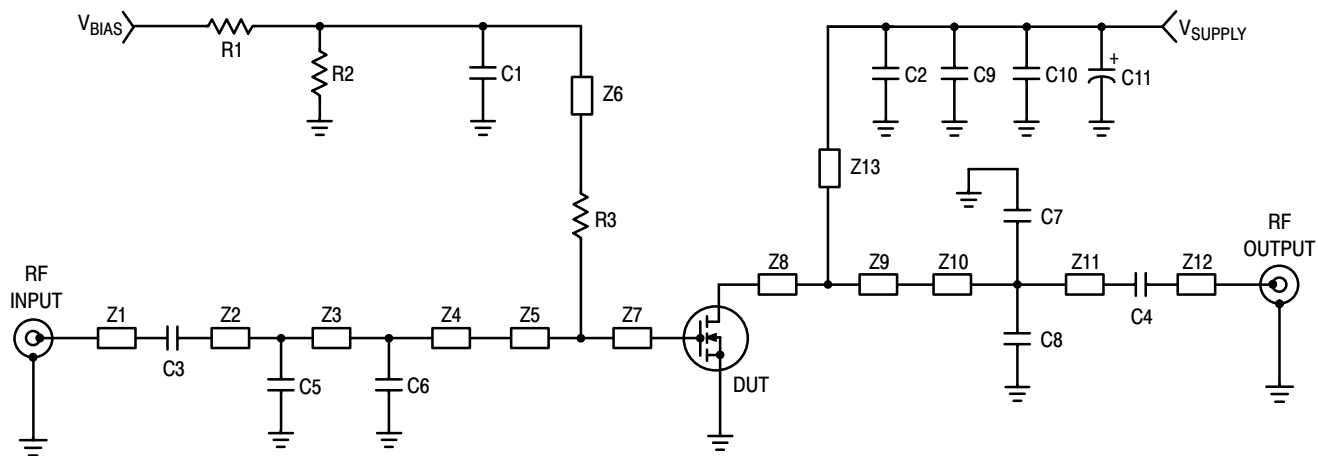

Z1	0.250" x 0.083" Microstrip	Z9	0.485" x 1.000" Microstrip
Z2*	0.950" x 0.083" Microstrip	Z10*	0.500" x 0.083" Microstrip
Z3*	0.250" x 0.083" Microstrip	Z11*	0.895" x 0.083" Microstrip
Z4*	0.315" x 0.083" Microstrip	Z12	0.250" x 0.083" Microstrip
Z5	0.365" x 1.000" Microstrip	Z13	0.200" x 0.080" Microstrip
Z6	0.680" x 0.080" Microstrip	PCB	Taconic TLX8-0300, 0.030", $\epsilon_r = 2.55$
Z7, Z8	0.115" x 1.000" Microstrip		* Variable for tuning

Figure 1. MRF6S18060NR1(NBR1) Test Circuit Schematic — 1900 MHz

Table 6. MRF6S18060NR1(NBR1) Test Circuit Component Designations and Values — 1900 MHz

Part	Description	Part Number	Manufacturer
C1, C2, C3, C4	6.8 pF 100B Chip Capacitors	100B6R8CW	ATC
C5	1.5 pF 100B Chip Capacitor	100B1R5BW	ATC
C6	1.8 pF 100B Chip Capacitor	100B1R8BW	ATC
C7, C8	1 pF 100B Chip Capacitors	100B1R0BW	ATC
C9, C10	10 μ F Chip Capacitors (2220)	C5750X5R1H106MT	TDK
C11	220 μ F, 63 V Electrolytic Capacitor, Radial	13668221	Philips
R1, R2	10 k Ω , 1/4 W Chip Resistors (1206)		
R3	10 Ω , 1/4 W Chip Resistor (1206)		

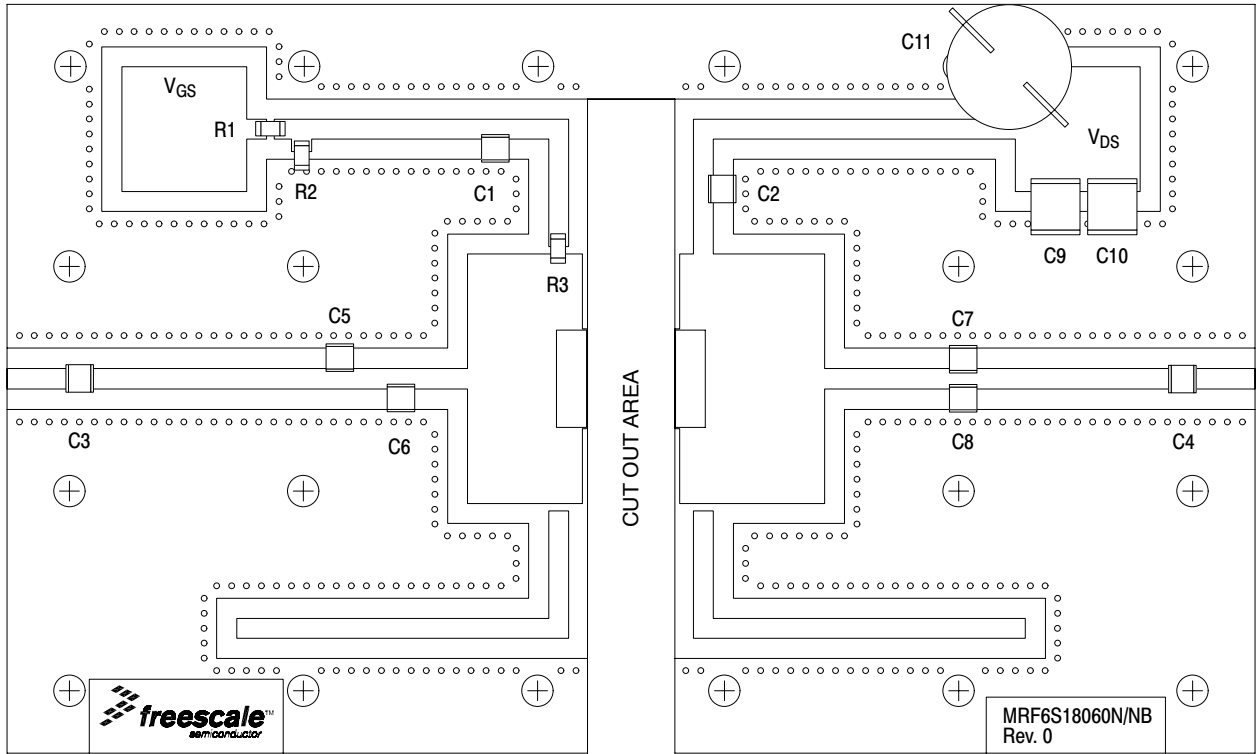

Figure 2. MRF6S18060NR1(NBR1) Test Circuit Component Layout — 1900 MHz

TYPICAL CHARACTERISTICS — 1900 MHz

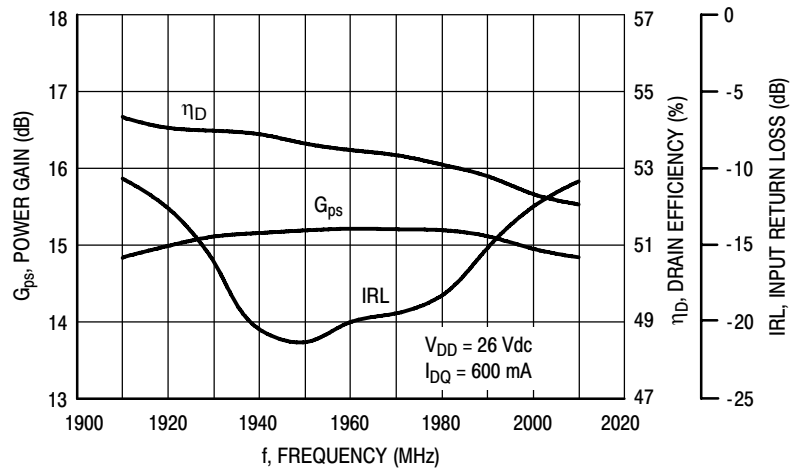

Figure 3. Power Gain, Input Return Loss and Drain Efficiency versus Frequency @ $P_{out} = 60$ Watts

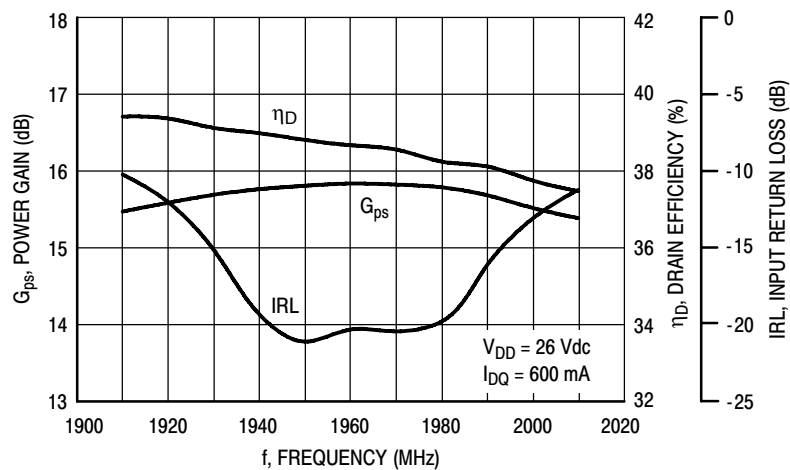

Figure 4. Power Gain, Input Return Loss and Drain Efficiency versus Frequency @ $P_{out} = 30$ Watts

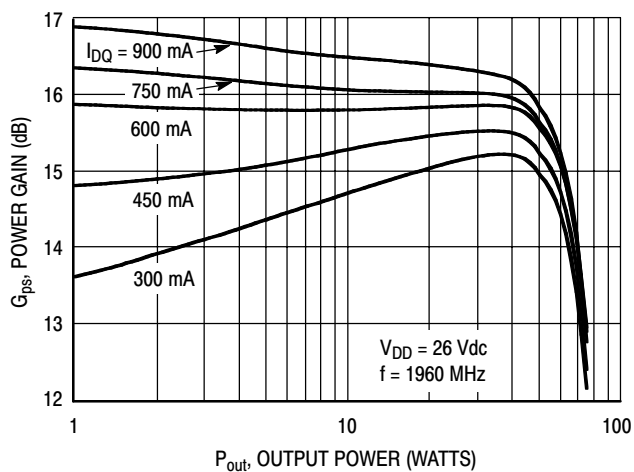

Figure 5. Power Gain versus Output Power

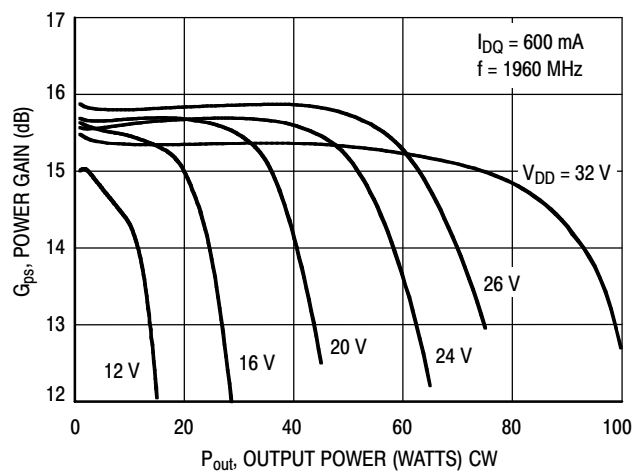

Figure 6. Power Gain versus Output Power

TYPICAL CHARACTERISTICS — 1900 MHz

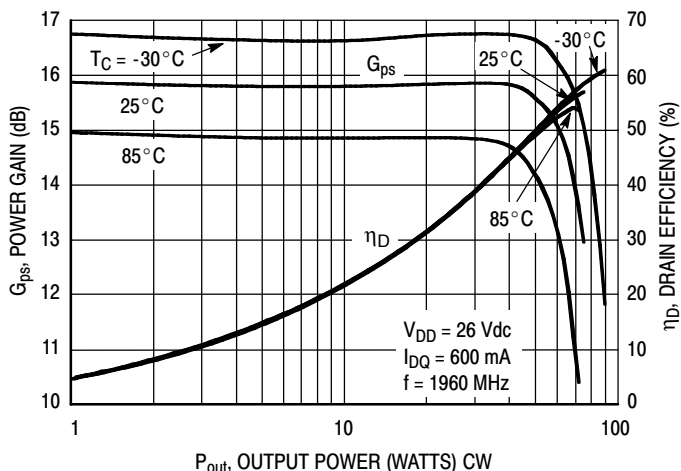

Figure 7. Power Gain and Drain Efficiency versus CW Output Power

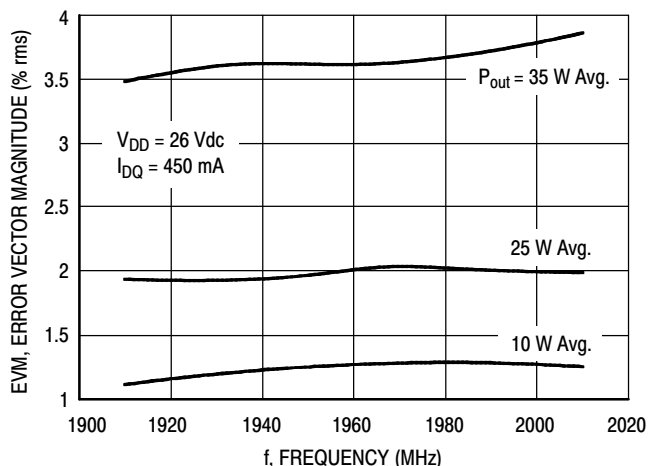

Figure 8. EVM versus Frequency

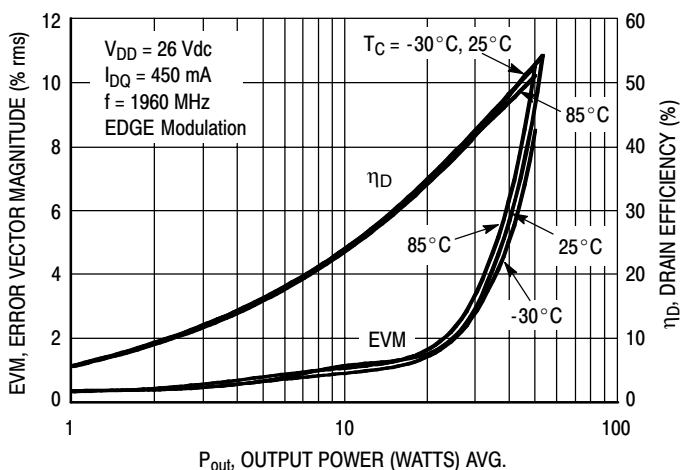

Figure 9. EVM and Drain Efficiency versus Output Power

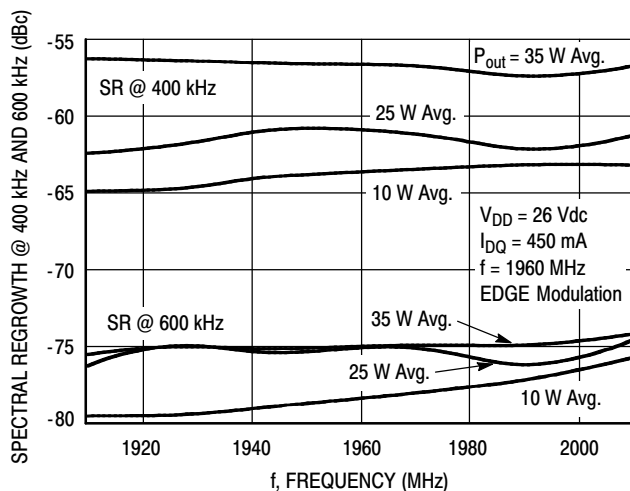

Figure 10. Spectral Regrowth at 400 kHz and 600 kHz versus Frequency

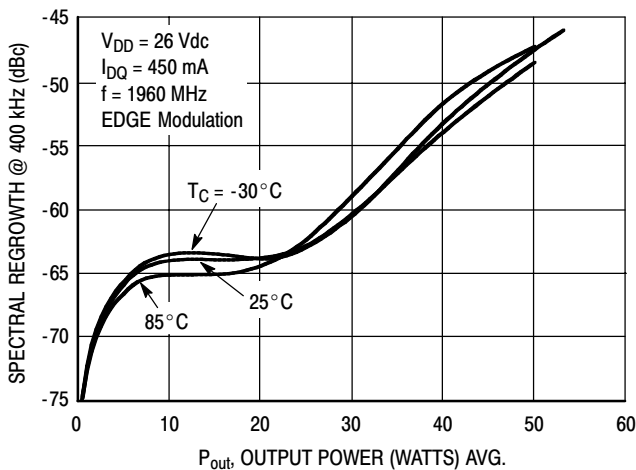

Figure 11. Spectral Regrowth at 400 kHz versus Output Power

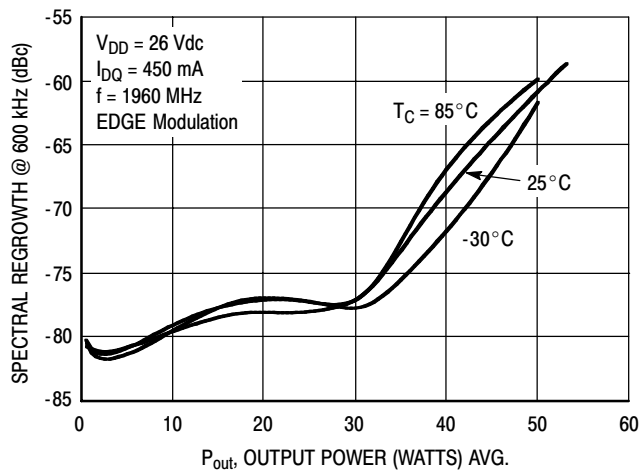
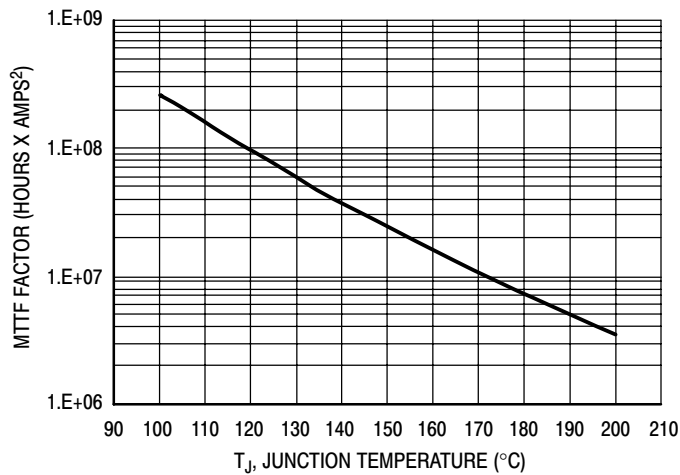

Figure 12. Spectral Regrowth at 600 kHz versus Output Power

TYPICAL CHARACTERISTICS



This above graph displays calculated MTTF in hours x ampere² drain current. Life tests at elevated temperatures have correlated to better than $\pm 10\%$ of the theoretical prediction for metal failure. Divide MTTF factor by I_D^2 for MTTF in a particular application.

Figure 13. MTTF Factor versus Junction Temperature

GSM TEST SIGNAL

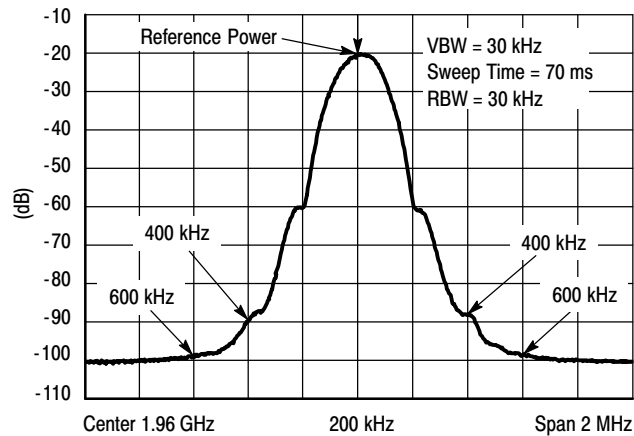
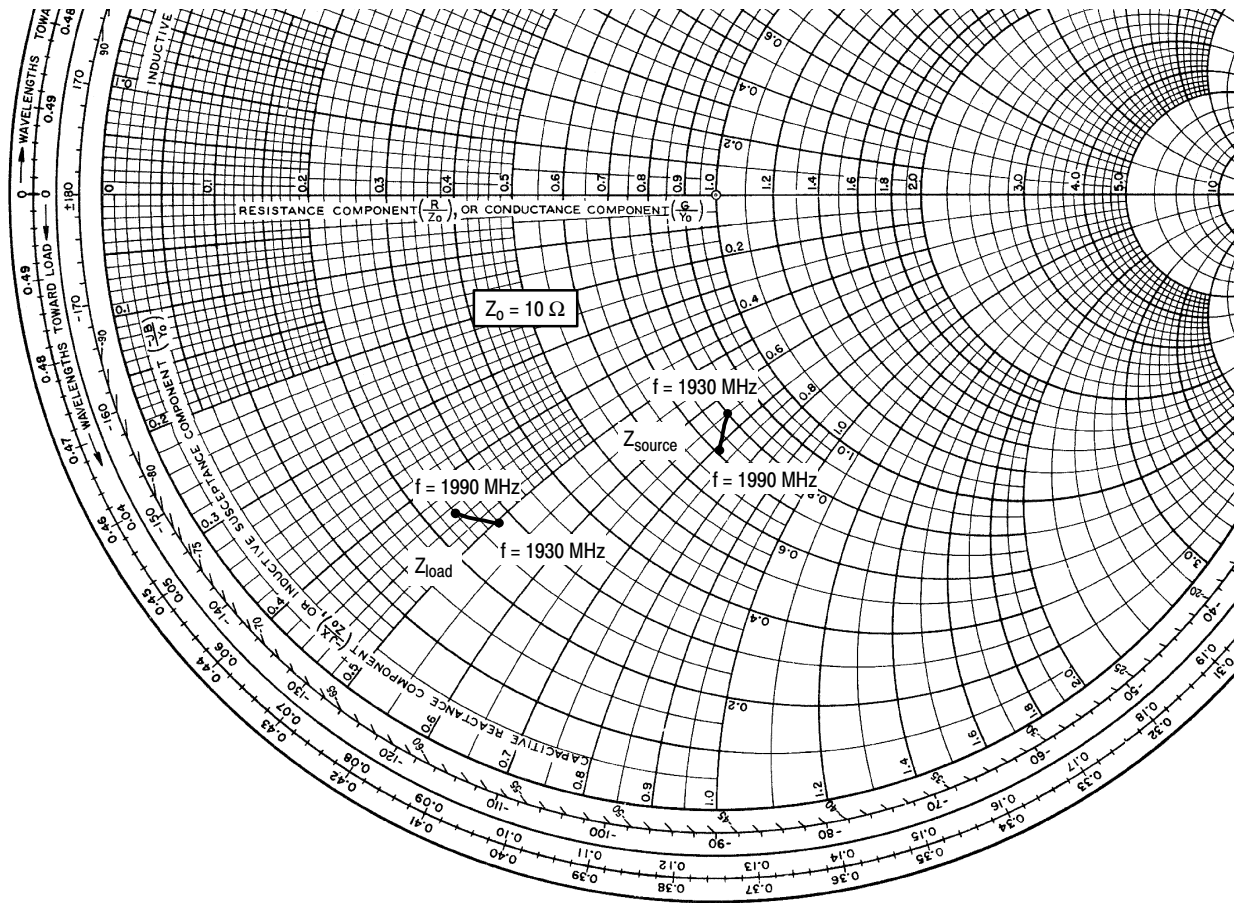

Figure 14. EDGE Spectrum



$V_{DD} = 26 \text{ Vdc}$, $I_{DQ} = 600 \text{ mA}$, $P_{out} = 60 \text{ W CW}$

f MHz	Z_{source} Ω	Z_{load} Ω
1930	$8.00 - j6.48$	$2.83 - j5.13$
1960	$7.57 - j6.82$	$2.63 - j4.84$
1990	$7.06 - j7.06$	$2.44 - j4.54$

Z_{source} = Test circuit impedance as measured from gate to ground.

Z_{load} = Test circuit impedance as measured from drain to ground.

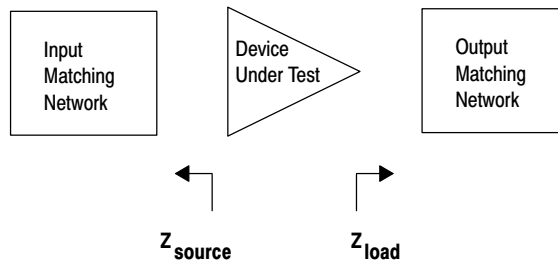
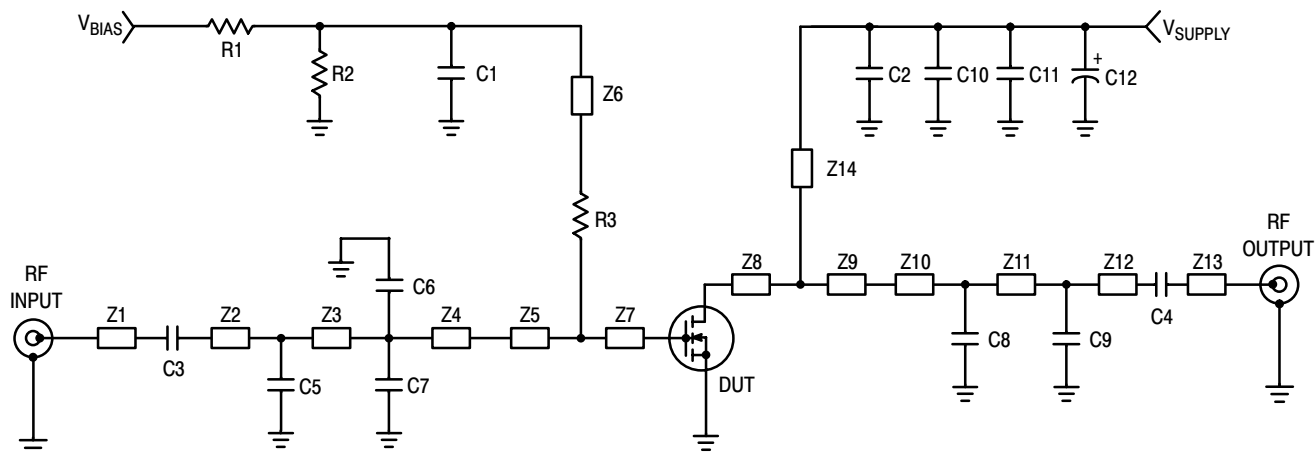

Figure 15. Series Equivalent Source and Load Impedance — 1900 MHz



Z1	0.250" x 0.083" Microstrip	Z9	0.485" x 1.000" Microstrip
Z2*	0.320" x 0.083" Microstrip	Z10*	0.420" x 0.083" Microstrip
Z3*	0.660" x 0.083" Microstrip	Z11*	0.230" x 0.083" Microstrip
Z4*	0.535" x 0.083" Microstrip	Z12*	0.745" x 0.083" Microstrip
Z5	0.365" x 1.000" Microstrip	Z13	0.250" x 0.083" Microstrip
Z6	0.860" x 0.080" Microstrip	Z14	0.640" x 0.080" Microstrip
Z7, Z8	0.115" x 1.000" Microstrip	PCB	Taconic TLX8-0300, 0.030", $\epsilon_r = 2.55$

* Variable for tuning

Figure 16. MRF6S18060NR1(NBR1) Test Circuit Schematic — 1800 MHz

Table 7. MRF6S18060NR1(NBR1) Test Circuit Component Designations and Values — 1800 MHz

Part	Description	Part Number	Manufacturer
C1, C2, C3, C4	6.8 pF 100B Chip Capacitors	100B6R8CW	ATC
C5	0.8 pF 600B Chip Capacitor	600B0R8BW	ATC
C6, C9	0.5 pF 600B Chip Capacitors	600B0R5BW	ATC
C7	2.2 pF 200B Chip Capacitor	200B2R2BW	ATC
C8	1.5 pF 600B Chip Capacitor	600B1R5BW	ATC
C10, C11	10 μ F Chip Capacitors (2220)	C5750X5R1H106MT	TDK
C12	220 μ F, 63 V Electrolytic Capacitor, Radial	13668221	Philips
R1, R2	10 k Ω , 1/4 W Chip Resistors (1206)		
R3	10 Ω , 1/4 W Chip Resistor (1206)		

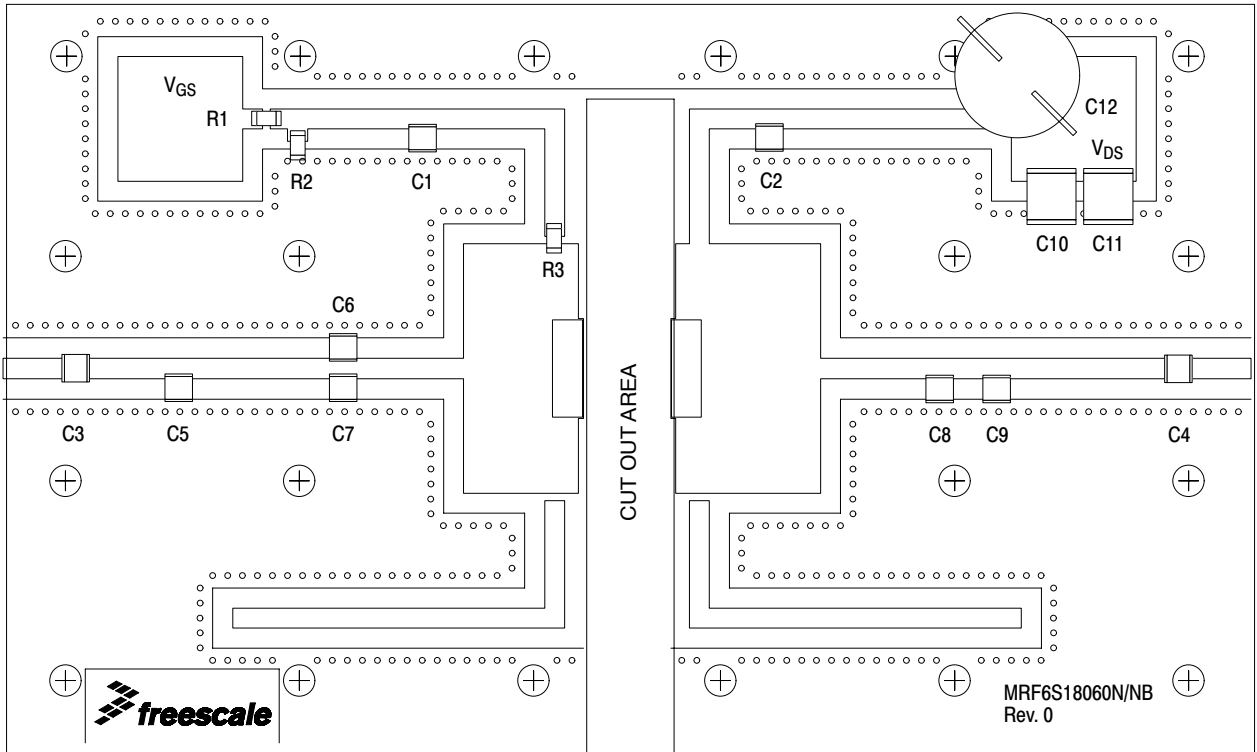

Figure 17. MRF6S18060NR1(NBR1) Test Circuit Component Layout — 180 MHz

TYPICAL CHARACTERISTICS — 1800 MHz

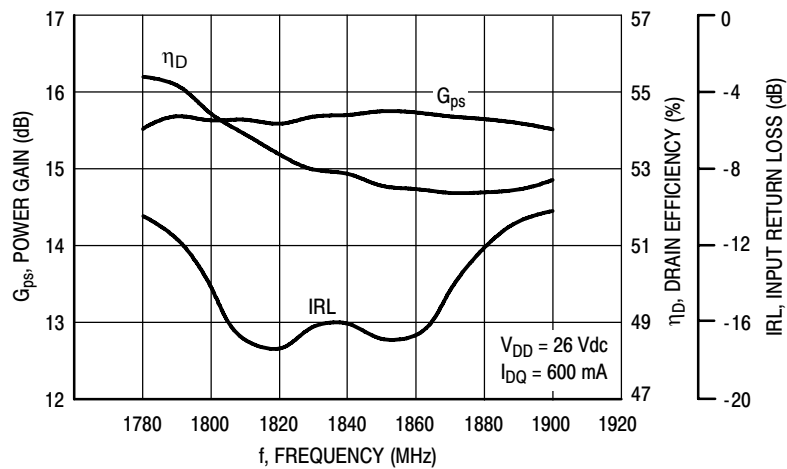

Figure 18. Power Gain, Input Return Loss and Drain Efficiency versus Frequency @ $P_{out} = 60$ Watts

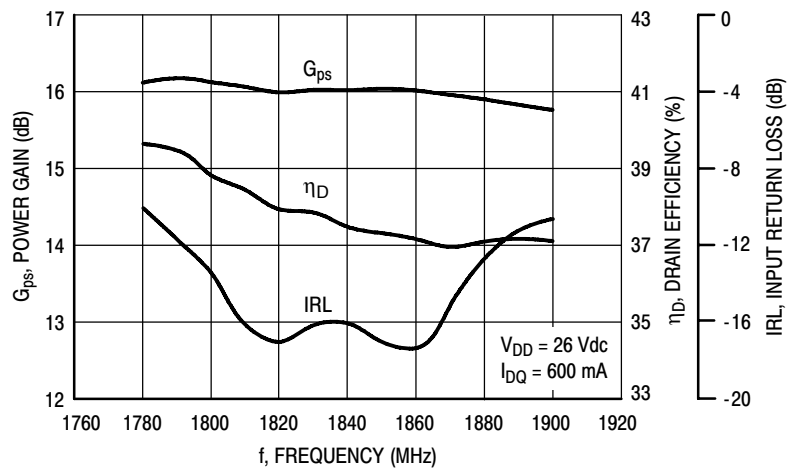

Figure 19. Power Gain, Input Return Loss and Drain Efficiency versus Frequency @ $P_{out} = 30$ Watts

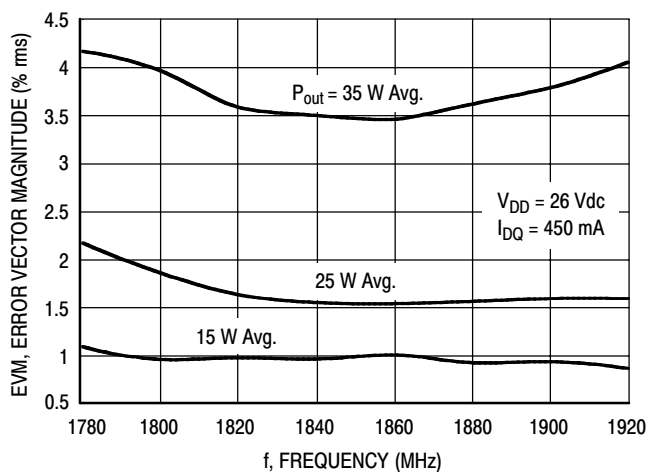

Figure 20. EVM versus Frequency

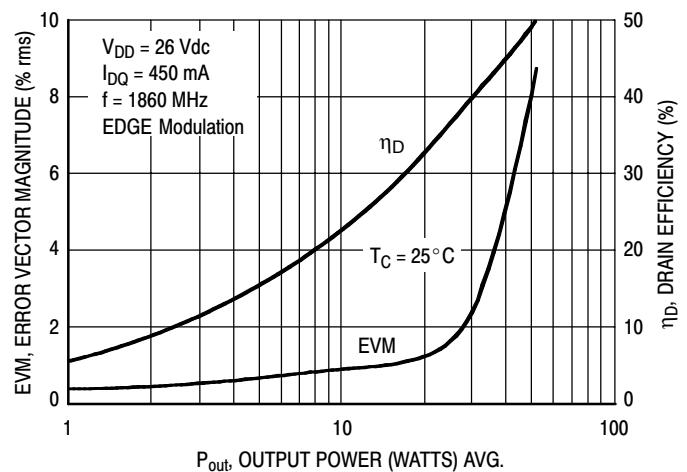

Figure 21. EVM and Drain Efficiency versus Output Power

TYPICAL CHARACTERISTICS — 1800 MHz

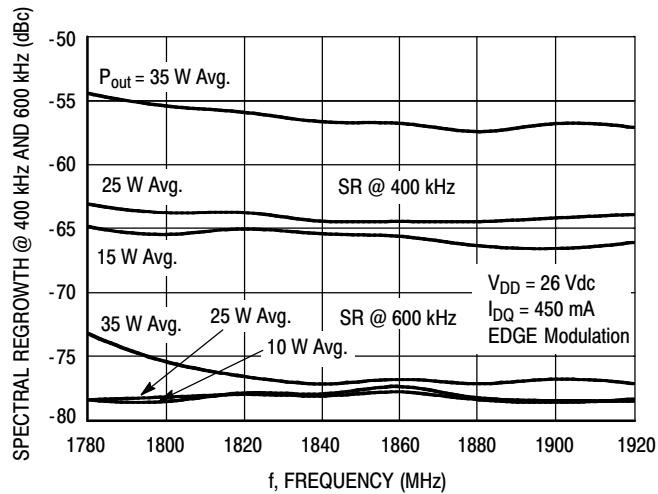

Figure 22. Spectral Regrowth at 400 kHz and 600 kHz versus Frequency

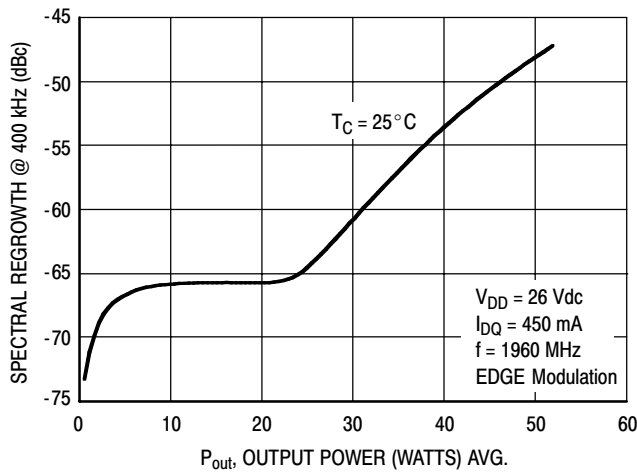

Figure 23. Spectral Regrowth at 400 kHz versus Output Power

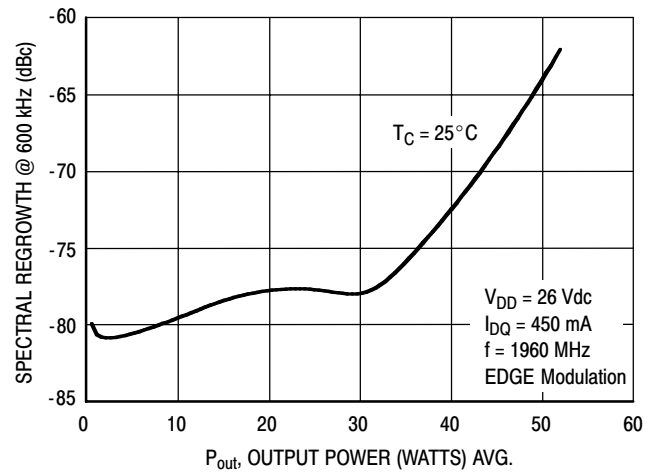
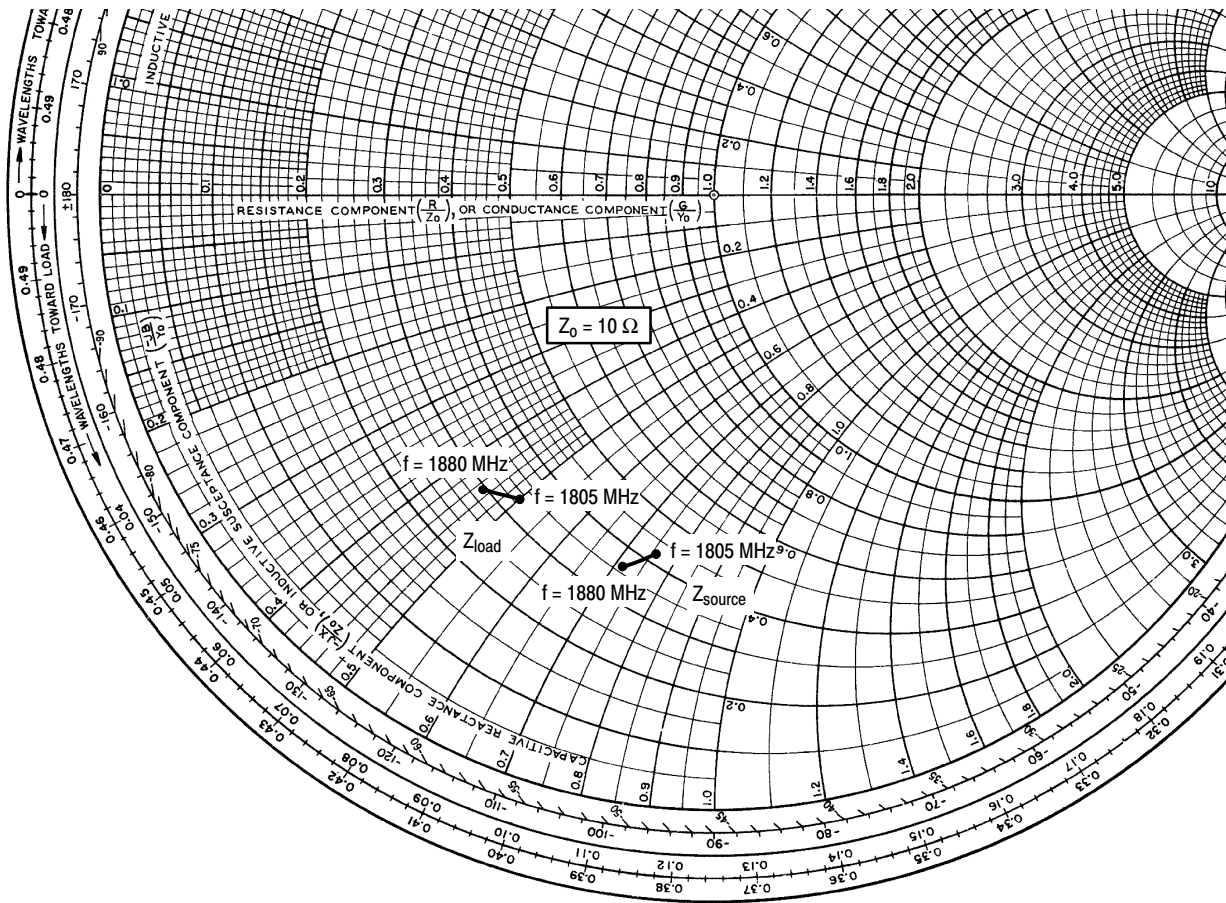

Figure 24. Spectral Regrowth at 600 kHz versus Output Power



$V_{DD} = 26 \text{ Vdc}$, $I_{DQ} = 600 \text{ mA}$, $P_{out} = 65 \text{ W CW}$

f MHz	Z_{source} Ω	Z_{load} Ω
1805	$4.16 - j7.56$	$3.29 - j4.91$
1840	$3.89 - j7.40$	$3.10 - j4.69$
1880	$3.56 - j7.21$	$2.88 - j4.45$

Z_{source} = Test circuit impedance as measured from gate to ground.

Z_{load} = Test circuit impedance as measured from drain to ground.

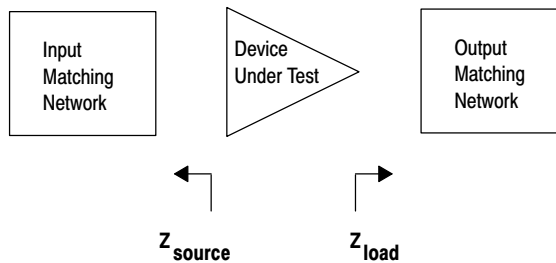
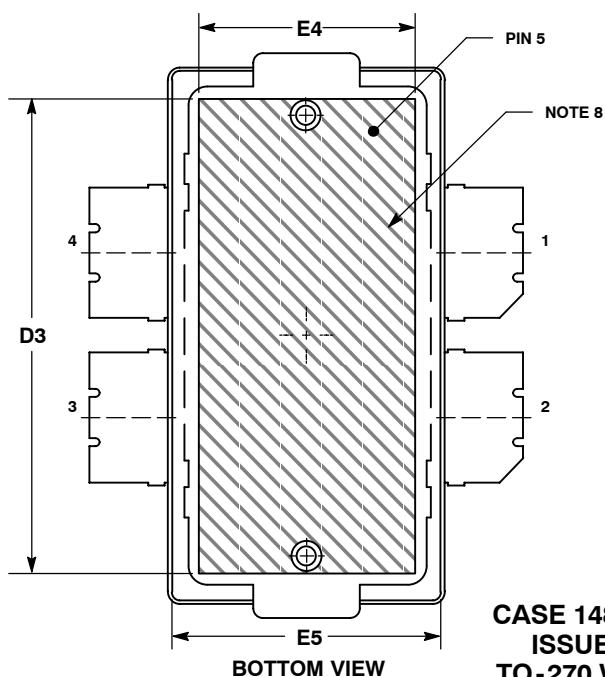
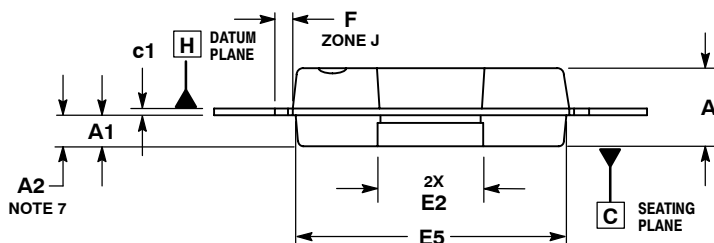
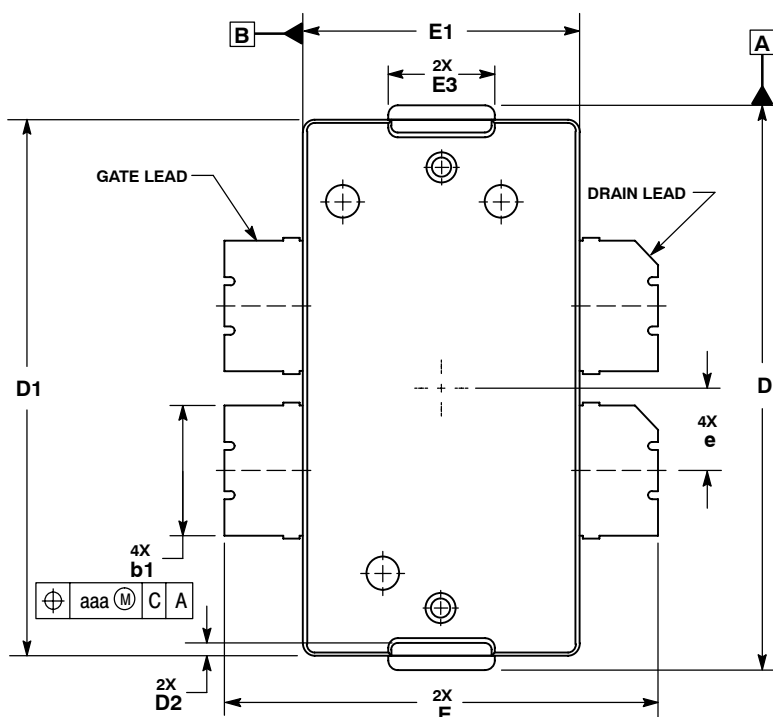

Figure 25. Series Equivalent Source and Load Impedance — 1800 MHz



NOTES

PACKAGE DIMENSIONS



- NOTES:
1. CONTROLLING DIMENSION: INCH.
 2. INTERPRET DIMENSIONS AND TOLERANCES PER ASME Y14.5M - 1994.
 3. DATUM PLANE -H- IS LOCATED AT THE TOP OF LEAD AND IS COINCIDENT WITH THE LEAD WHERE THE LEAD EXITS THE PLASTIC BODY AT THE TOP OF THE PARTING LINE.
 4. DIMENSIONS "D" AND "E1" DO NOT INCLUDE MOLD PROTRUSION. ALLOWABLE PROTRUSION IS .006 PER SIDE. DIMENSIONS "D" AND "E1" DO INCLUDE MOLD MISMATCH AND ARE DETERMINED AT DATUM PLANE -H-.
 5. DIMENSION "b1" DOES NOT INCLUDE DAMBAR PROTRUSION. ALLOWABLE DAMBAR PROTRUSION SHALL BE .005 TOTAL IN EXCESS OF THE "b1" DIMENSION AT MAXIMUM MATERIAL CONDITION.
 6. DATUMS -A- AND -B- TO BE DETERMINED AT DATUM PLANE -H-.
 7. DIMENSION A2 APPLIES WITHIN ZONE "J" ONLY.
 8. HATCHING REPRESENTS THE EXPOSED AREA OF THE HEAT SLUG.

DIM	INCHES		MILLIMETERS	
	MIN	MAX	MIN	MAX
A	.100	.104	2.54	2.64
A1	.039	.043	0.99	1.09
A2	.040	.042	1.02	1.07
D	.712	.720	18.08	18.29
D1	.688	.692	17.48	17.58
D2	.011	.019	0.28	0.48
D3	.600	---	15.24	---
E	.551	.559	14	14.2
E1	.353	.357	8.97	9.07
E2	.132	.140	3.35	3.56
E3	.124	.132	3.15	3.35
E4	.270	---	6.86	---
E5	.346	.350	8.79	8.89
F	.025 BSC		0.64 BSC	
b1	.164	.170	4.17	4.32
c1	.007	.011	0.18	0.28
e	.106 BSC		2.69 BSC	
aaa	.004		0.10	

- STYLE 1:
 PIN 1. DRAIN
 2. DRAIN
 3. GATE
 4. GATE
 5. SOURCE

**CASE 1486-03
 ISSUE C
 TO-270 WB-4
 PLASTIC
 MRF6S18060NR1**

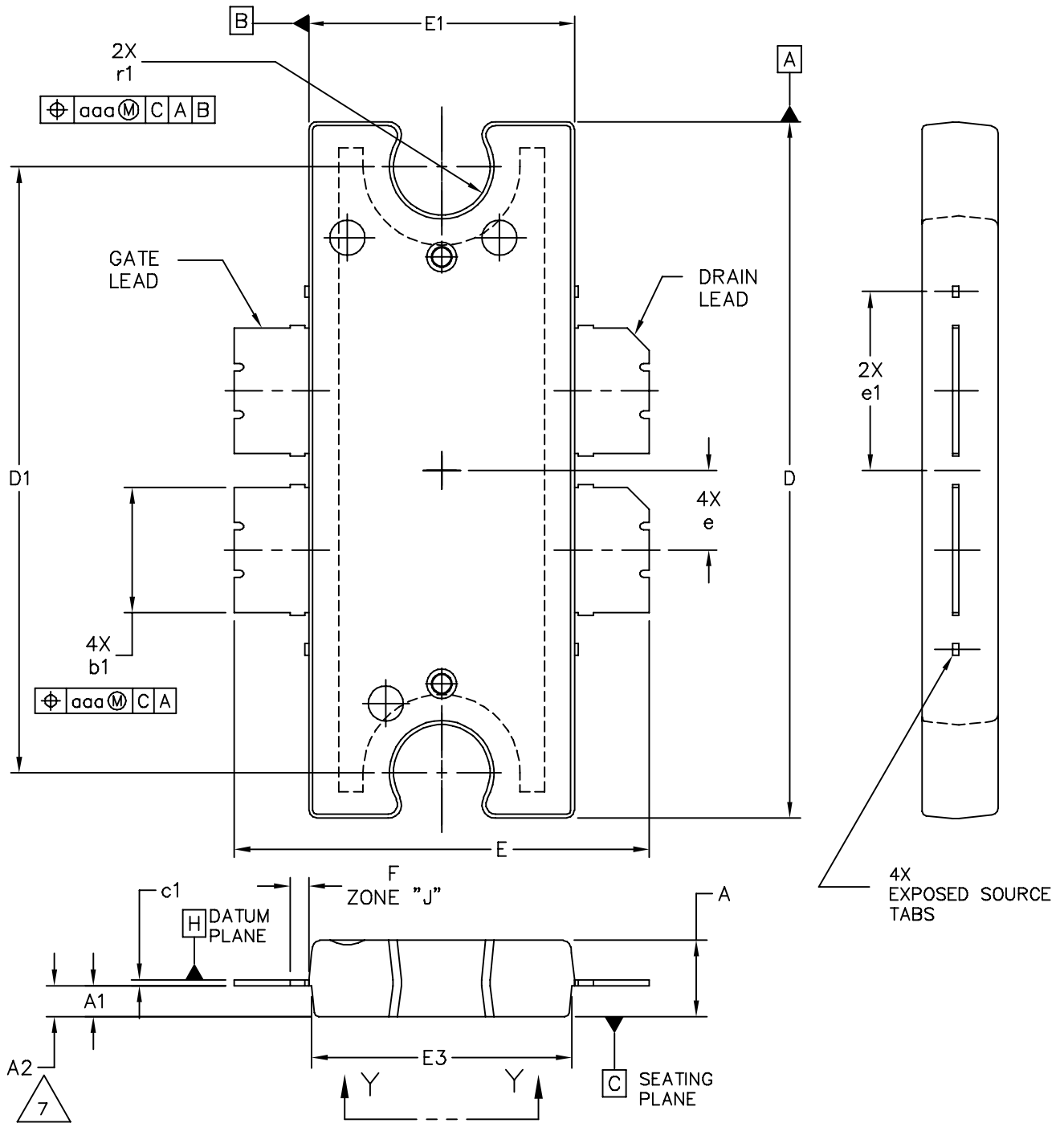

© FREESCALE SEMICONDUCTOR, INC. ALL RIGHTS RESERVED.		MECHANICAL OUTLINE		PRINT VERSION NOT TO SCALE	
TITLE: TO-272 4 LEAD, WIDE BODY			DOCUMENT NO: 98ASA10575D		REV: D
			CASE NUMBER: 1484-04		05 APR 2006
			STANDARD: NON-JEDEC		

MRF6S18060NR1 MRF6S18060NBR1

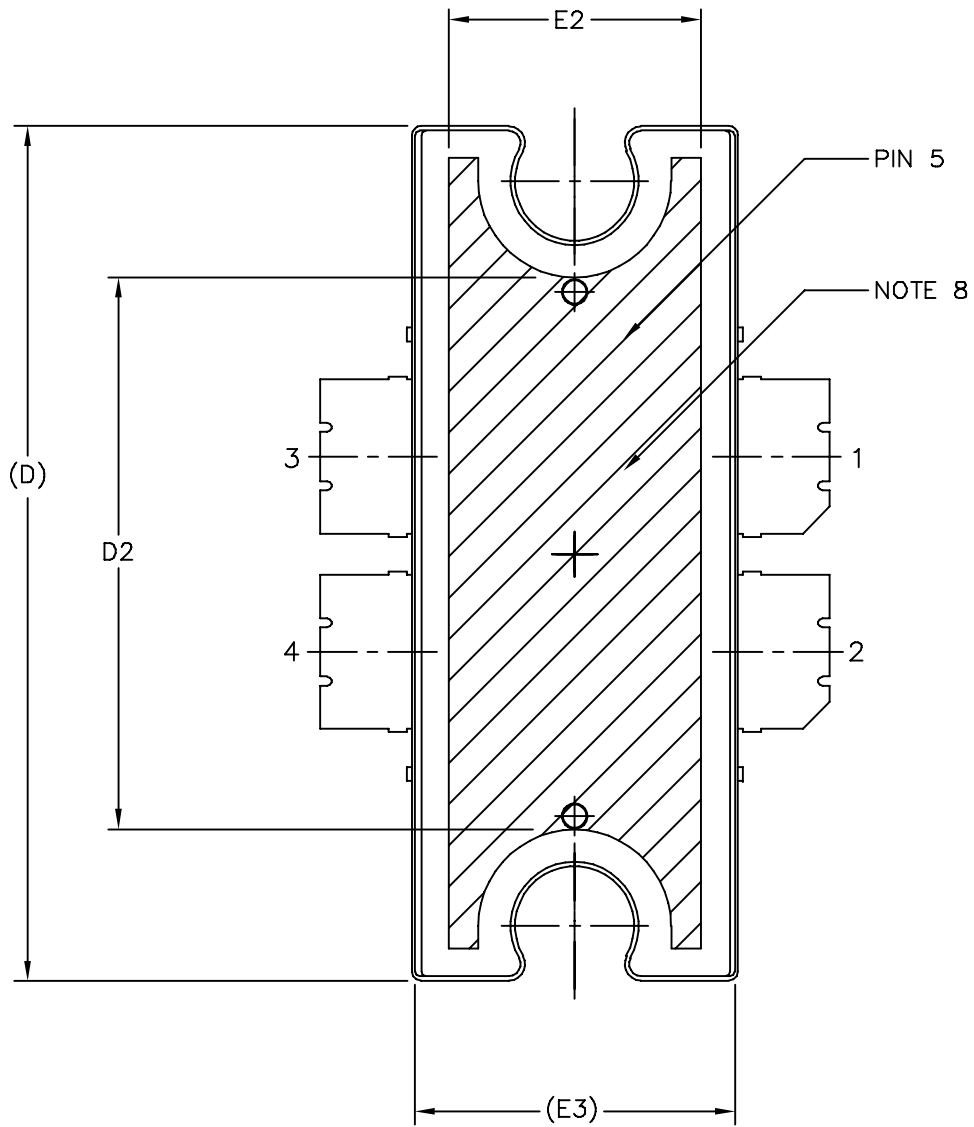

© FREESCALE SEMICONDUCTOR, INC. ALL RIGHTS RESERVED.	MECHANICAL OUTLINE	PRINT VERSION NOT TO SCALE	
TITLE: TO-272 4 LEAD, WIDE BODY	DOCUMENT NO: 98ASA10575D	REV: D	
	CASE NUMBER: 1484-04	05 APR 2006	
	STANDARD: NON-JEDEC		

NOTES:

1. CONTROLLING DIMENSION: INCH
2. INTERPRET DIMENSIONS AND TOLERANCES PER ASME Y14.5M-1994.
3. DATUM PLANE H IS LOCATED AT THE TOP OF LEAD AND IS COINCIDENT WITH THE LEAD WHERE THE LEAD EXITS THE PLASTIC BODY AT THE TOP OF THE PARTING LINE.
4. DIMENSIONS "D" AND "E1" DO NOT INCLUDE MOLD PROTRUSION. ALLOWABLE PROTRUSION IS .006 PER SIDE. DIMENSIONS "D" AND "E1" DO INCLUDE MOLD MISMATCH AND ARE DETERMINED AT DATUM PLANE H.
5. DIMENSIONS "b1" DOES NOT INCLUDE DAMBAR PROTRUSION. ALLOWABLE DAMBAR PROTRUSION SHALL BE .005 TOTAL IN EXCESS OF THE "b1" DIMENSION AT MAXIMUM MATERIAL CONDITION.
6. DATUM A AND B TO BE DETERMINED AT DATUM PLANE H.
7. DIMENSION A2 APPLIES WITHIN ZONE "J" ONLY.
8. HATCHING REPRESENTS EXPOSED AREA OF THE HEAT SLUG. HATCHED AREA SHOWN IS ON THE SAME PLANE.

STYLE 1:

PIN 1 - DRAIN PIN 2 - DRAIN
 PIN 3 - GATE PIN 4 - GATE
 PIN 5 - SOURCE

DIM	INCH		MILLIMETER		DIM	INCH		MILLIMETER	
	MIN	MAX	MIN	MAX		MIN	MAX	MIN	MAX
A	.100	.104	2.54	2.64	b1	.164	.170	4.17	4.32
A1	.039	.043	0.99	1.09	c1	.007	.011	.18	.28
A2	.040	.042	1.02	1.07	r1	.063	.068	1.60	1.73
D	.928	.932	23.57	23.67	e	.106 BSC		2.69 BSC	
D1	.810 BSC		20.57 BSC		e1	.239 INFO ONLY		6.07 INFO ONLY	
D2	.600	---	15.24	---	aaa	.004		.10	
E	.551	.559	14	14.2					
E1	.353	.357	8.97	9.07					
E2	.270	---	6.86	---					
E3	.346	.350	8.79	8.89					
F	.025 BSC		0.64 BSC						

© FREESCALE SEMICONDUCTOR, INC.
 ALL RIGHTS RESERVED.

MECHANICAL OUTLINE

PRINT VERSION NOT TO SCALE

TITLE:

TO-272
 4 LEAD WIDE BODY

DOCUMENT NO: 98ASA10575D

REV: D

CASE NUMBER: 1484-04

05 APR 2006

STANDARD: NON-JEDEC

How to Reach Us:

Home Page:

www.freescale.com

E-mail:

support@freescale.com

USA/Europe or Locations Not Listed:

Freescale Semiconductor
Technical Information Center, CH370
1300 N. Alma School Road
Chandler, Arizona 85224
+1-800-521-6274 or +1-480-768-2130
support@freescale.com

Europe, Middle East, and Africa:

Freescale Halbleiter Deutschland GmbH
Technical Information Center
Schatzbogen 7
81829 Muenchen, Germany
+44 1296 380 456 (English)
+46 8 52200080 (English)
+49 89 92103 559 (German)
+33 1 69 35 48 48 (French)
support@freescale.com

Japan:

Freescale Semiconductor Japan Ltd.
Headquarters
ARCO Tower 15F
1-8-1, Shimo-Meguro, Meguro-ku,
Tokyo 153-0064
Japan
0120 191014 or +81 3 5437 9125
support.japan@freescale.com

Asia/Pacific:

Freescale Semiconductor Hong Kong Ltd.
Technical Information Center
2 Dai King Street
Tai Po Industrial Estate
Tai Po, N.T., Hong Kong
+800 2666 8080
support.asia@freescale.com

For Literature Requests Only:

Freescale Semiconductor Literature Distribution Center
P.O. Box 5405
Denver, Colorado 80217
1-800-441-2447 or 303-675-2140
Fax: 303-675-2150
LDCForFreescaleSemiconductor@hibbertgroup.com

Information in this document is provided solely to enable system and software implementers to use Freescale Semiconductor products. There are no express or implied copyright licenses granted hereunder to design or fabricate any integrated circuits or integrated circuits based on the information in this document.

Freescale Semiconductor reserves the right to make changes without further notice to any products herein. Freescale Semiconductor makes no warranty, representation or guarantee regarding the suitability of its products for any particular purpose, nor does Freescale Semiconductor assume any liability arising out of the application or use of any product or circuit, and specifically disclaims any and all liability, including without limitation consequential or incidental damages. "Typical" parameters that may be provided in Freescale Semiconductor data sheets and/or specifications can and do vary in different applications and actual performance may vary over time. All operating parameters, including "Typicals", must be validated for each customer application by customer's technical experts. Freescale Semiconductor does not convey any license under its patent rights nor the rights of others. Freescale Semiconductor products are not designed, intended, or authorized for use as components in systems intended for surgical implant into the body, or other applications intended to support or sustain life, or for any other application in which the failure of the Freescale Semiconductor product could create a situation where personal injury or death may occur. Should Buyer purchase or use Freescale Semiconductor products for any such unintended or unauthorized application, Buyer shall indemnify and hold Freescale Semiconductor and its officers, employees, subsidiaries, affiliates, and distributors harmless against all claims, costs, damages, and expenses, and reasonable attorney fees arising out of, directly or indirectly, any claim of personal injury or death associated with such unintended or unauthorized use, even if such claim alleges that Freescale Semiconductor was negligent regarding the design or manufacture of the part.

Freescale™ and the Freescale logo are trademarks of Freescale Semiconductor, Inc. All other product or service names are the property of their respective owners.
© Freescale Semiconductor, Inc. 2006. All rights reserved.

RoHS-compliant and/or Pb-free versions of Freescale products have the functionality and electrical characteristics of their non-RoHS-compliant and/or non-Pb-free counterparts. For further information, see <http://www.freescale.com> or contact your Freescale sales representative.

For information on Freescale's Environmental Products program, go to <http://www.freescale.com/epp>.

