

Agilent MGA-545P8

1–7 GHz Medium Power Amplifier

Data Sheet

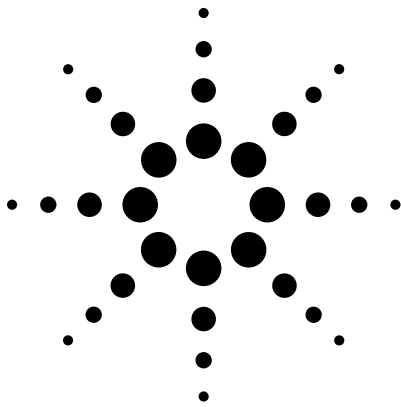

Description

Agilent's MGA-545P8 is an economical, low current, medium power, easy-to-use GaAs MMIC amplifier that offers excellent power output at 5.8 GHz. Although optimized for 5.8 GHz applications, the MGA-545P8 is suitable for other applications in the 1 to 7 GHz frequency range.

With the addition of a simple input match, the MGA-545P8 offers a small signal gain of 11.5 dB, a saturated power output of 22 dBm and a saturated gain of 9.5 dB at

5.8 GHz. The MGA-545P8 has a nominal current consumption of 92 mA in saturated mode and 135 mA in linear mode at a device voltage of 3.3 V with power added efficiency of 46% in saturated mode.

The MGA-545P8 is housed in the 2X2 mm-8L LPCC package. This package offers good thermal dissipation and very good high frequency characteristics making it appropriate for medium power applications through 7 GHz.

Pin Connections and Package Marking

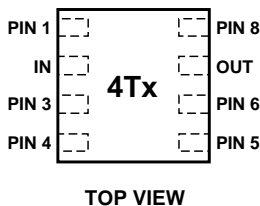
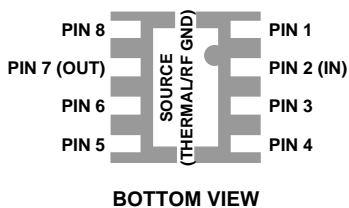

Note: Package marking provides orientation and identification.
 "4T" = Device Code
 "x" = Date code indicates the month of manufacture.

Simplified Schematic

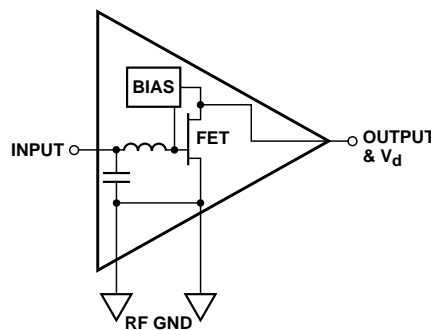

Specifications

- 3.3 V, 92 mA, 5.825 GHz at saturation mode
- 22 dBm saturated power across 1-7 GHz
- 9.5 dB gain
- 46% PAE
- 3.3 V, 135 mA, 5.825 GHz at linear mode
- 11.5 dB small signal gain
- Pout = 16 dBm at 5.6% EVM
- 34 dBm OIP3 at 2.7 V

Features

- Unconditionally stable
- Single +3.3 V operation
- Small package size – 2.0 x 2.0 x 0.75 mm³
- Point MTTF > 300 years [2]
- MSL-1 and Pb-free and Halogen-free
- Tape-and-reel packaging option available

Applications

The MGA-545P8 is ideal for use as driver amplifier or power amplifier in:

- 3-4 GHz fixed wireless access (WLL)
- 5-6 GHz fixed wireless access (HiperLAN/UNII)
- 5-6 GHz WLAN 802.11a NIC and AP
- Other applications in the 1-7 GHz frequency range

Notes:

1. Enhancement mode technology employs a single positive V_{gs} , eliminating the need of negative gate voltage associated with conventional depletion mode devices.
2. Refer to reliability datasheet for detailed MTTF data.
3. Conform to JEDEC reference outline M0229 for DRP-N.



MGA-545P8 Absolute Maximum Ratings^[1]

| Parameter | Units | Absolute Maximum |
|---|-----------------------------|------------------|
| V_d Device Voltage, RF output to ground | V | 5.0 |
| P_{in} CW RF Input Power | dBm | 20 |
| θ_{jc} Thermal Resistance ^[2] | $^{\circ}\text{C}/\text{W}$ | 124 |
| P_{diss} Total Power Dissipation ^[3] | W | 0.8 |
| T_j Junction Temperature | $^{\circ}\text{C}$ | 150 |
| T_{STG} Storage Temperature | $^{\circ}\text{C}$ | -65 to 150 |

Notes:

1. Operation of this device in excess of any of these limits may cause permanent damage.
2. Thermal resistance measured using 150 $^{\circ}\text{C}$ Liquid Crystal Measurement Technique.
3. Board (package belly) temperature T_b is 25 $^{\circ}\text{C}$. Derate 8 mW/ $^{\circ}\text{C}$ for $T_b > 51^{\circ}\text{C}$.

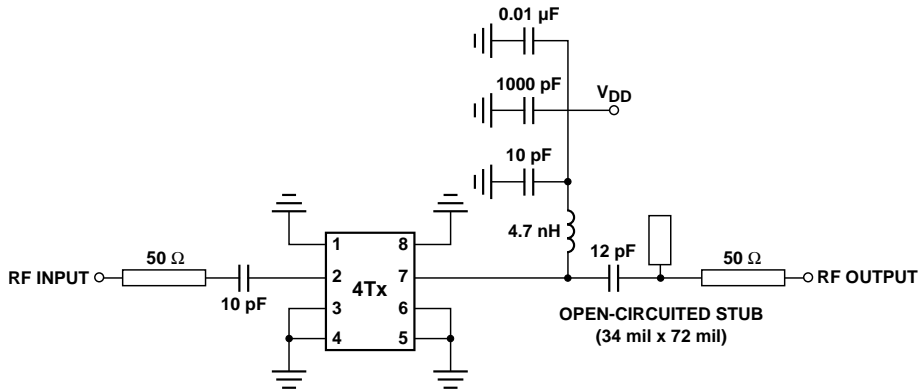

Figure 1. Production test circuit.

This circuit represents a match for maximum gain and saturated power.

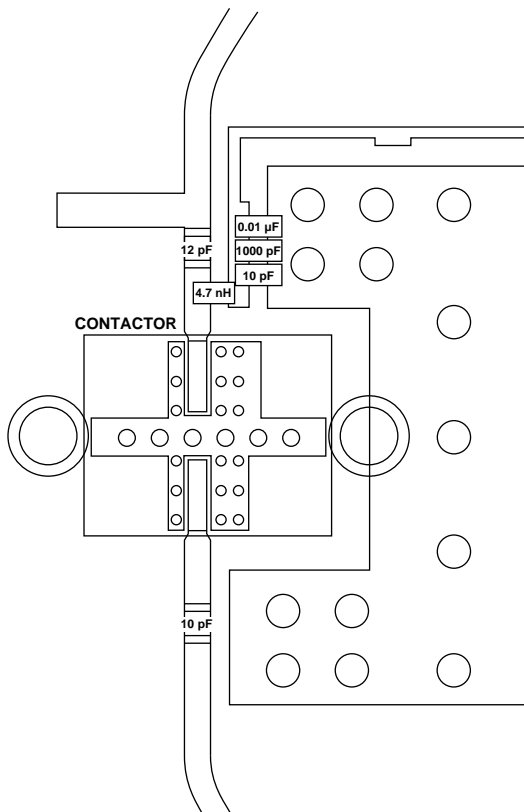

Figure 2. Close-up of production test board. Rogers 4350 Er = 3.48 \pm 0.05, thickness = 10 mils.

MGA-545P8 Electrical Specifications

T_c = 25°C, V_d = 3.3 V, unless otherwise noted

| Symbol | Parameter and Test Condition | | Units | Min. | Typ. | Max. |
|-----------|--|------------------------------|-------|------|-------|------|
| Gtest_sat | Gain in test circuit at saturation <i>For all frequencies refer to note [3] unless noted otherwise</i> | f = 1.0 GHz | dB | 8.5 | 20.0 | 10.5 |
| | | f = 2.0 GHz | | | 16.3 | |
| | | f = 3.0 GHz | | | 13.4 | |
| | | f = 4.0 GHz | | | 11.6 | |
| | | f = 5.0 GHz | | | 10.05 | |
| | | f = 5.825 GHz ^[1] | | | 9.5 | |
| Gtest_ss | Gain in test circuit at small signal <i>For all frequencies refer to note [3] unless noted otherwise</i> | f = 1.0 GHz | dB | 10.5 | 22.4 | 13.8 |
| | | f = 2.0 GHz | | | 18.6 | |
| | | f = 3.0 GHz | | | 15.9 | |
| | | f = 4.0 GHz | | | 13.5 | |
| | | f = 5.0 GHz | | | 12 | |
| | | f = 5.825 GHz ^[1] | | | 11.5 | |
| Psat | Pout at 2.5 dB gain compression | f = 5.825 GHz ^[1] | dBm | 21.5 | 22 | – |
| Ids_sat | Drain Current at saturation | f = 5.825 GHz ^[1] | mA | 80 | 92 | 115 |
| Idss | Drain Current at small signal | f = 5.825 GHz ^[1] | mA | 95 | 135 | 155 |
| P1dB | Output Power at 1 dB compression point <i>For all frequencies refer to note [3] unless noted otherwise</i> | f = 1.0 GHz | dBm | | 21.5 | |
| | | f = 2.0 GHz | | | 21.7 | |
| | | f = 3.0 GHz | | | 21.3 | |
| | | f = 4.0 GHz | | | 21.8 | |
| | | f = 5.0 GHz | | | 21.2 | |
| | | f = 5.825 GHz ^[2] | | | 21.0 | |
| PAE | Power Added Efficiency at Psat ^[4] <i>For all frequencies refer to note [3] unless noted otherwise</i> | f = 1.0 GHz | % | 40 | 46.3 | |
| | | f = 2.0 GHz | | | 46.0 | |
| | | f = 3.0 GHz | | | 48 | |
| | | f = 4.0 GHz | | | 44 | |
| | | f = 5.0 GHz | | | 45 | |
| | | f = 5.825 GHz ^[1] | | | 46 | |
| OIP3 | Output Third Order Intercept Point [2.7 V] | f = 5.725 GHz ^[1] | dBm | 31 | 34 | – |
| EVM | Error Vector Magnitude Pout = 16 dBm; 54 Mbps data rate | f = 5.725 GHz ^[2] | % | | 5.6 | |
| NF | Noise Figure <i>For all frequencies refer to note [3] unless noted otherwise.</i> | f = 1.0 GHz | dB | | 2.6 | |
| | | f = 2.0 GHz | | | 2.7 | |
| | | f = 3.0 GHz | | | 2.9 | |
| | | f = 4.0 GHz | | | 3.3 | |
| | | f = 5.0 GHz | | | 3.6 | |
| | | f = 5.825 GHz ^[2] | | | 4.4 | |
| | | f = 6.0 GHz | | | 5.2 | |

Notes:

- Measurements made on a fixed tuned production test board (figure 1), which was optimized for gain and saturated power. Excess circuit losses had been de-embedded from actual measurement. Typical data based on at least 500 parts sample size from 3 wafer lots. Future wafers allocated to this product may have nominal values anywhere within the upper and lower spec limits.
- Measurement was taken on demo board at which it was tuned for maximum gain and saturated power. Refer to application note.
- Measurement was done in a 50 Ω microstrip line, which was tuned for maximum gain and saturated power for each frequency with external double stub tuners.
- Power Added Efficiency at Psat is calculated using the following formula:

$$\eta_{pa} = \frac{P_{out}}{V_{dd} \times I_d}$$

P_{out} = Psat in watts
 Pin = Input drive power in watts
 V_{dd} = 3.3 V
 I_d = I_{ds_sat} in Ampere

MGA-545P8 Typical Performance, $T_c = 25^\circ\text{C}$, $V_d = 3.3\text{ V}$ unless stated otherwise.

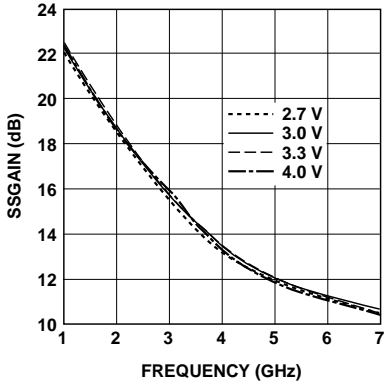

Figure 3. Small signal gain vs. frequency and voltage^[1,5].

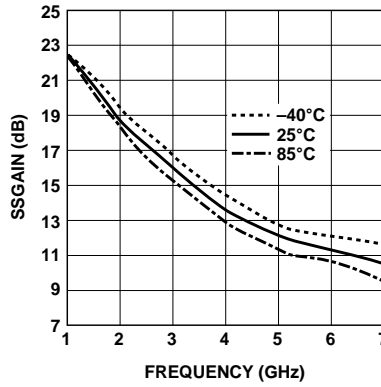

Figure 4. Small signal gain vs. frequency and temperature^[1,5].

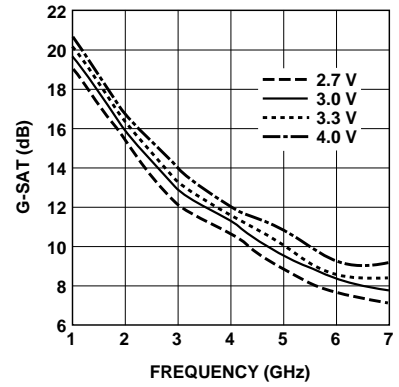

Figure 5. Saturated gain vs. frequency and voltage^[2,3,5].

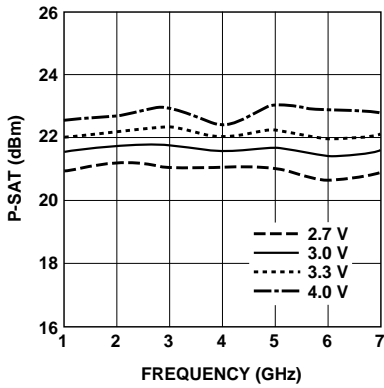

Figure 6. Saturated power vs. frequency and voltage^[2,3,5].

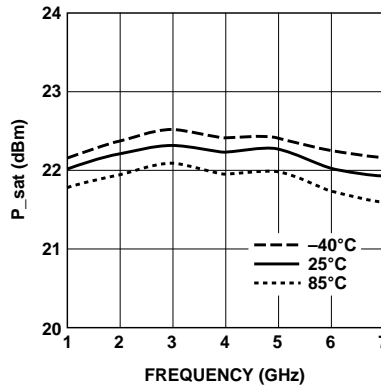

Figure 7. Saturated power vs. frequency and temperature^[2,3,5].

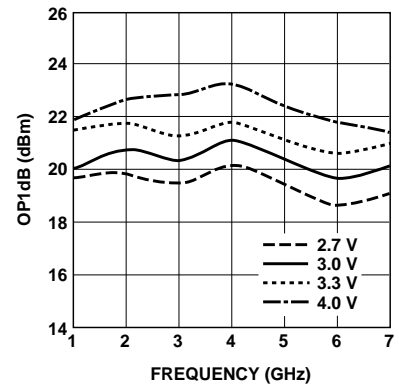

Figure 8. Output power at 1 dB gain compression vs. frequency and voltage^[2,5].

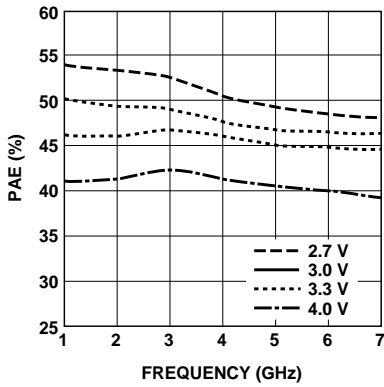

Figure 9. Power added efficiency vs. frequency and voltage^[2,3,5].

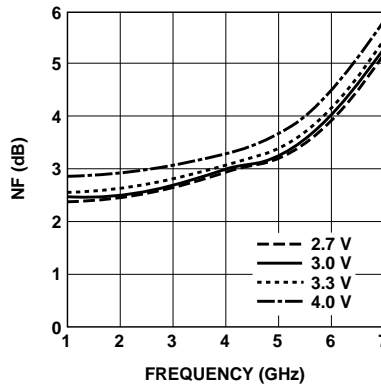

Figure 10. Noise figure vs. frequency and voltage^[2,5].

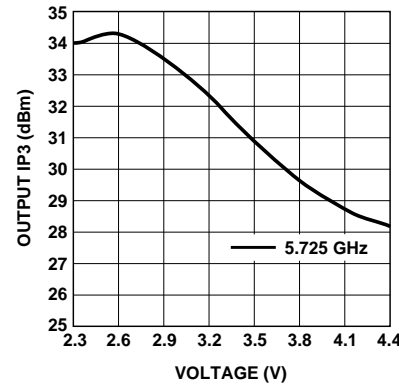

Figure 11. OIP3 vs. voltage at 5.725 GHz^[4,5].

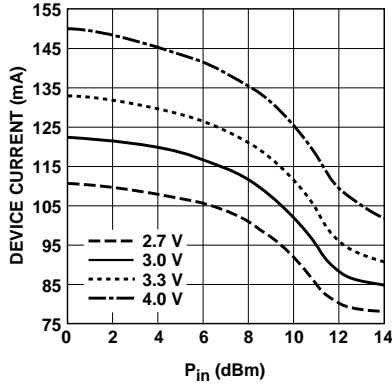

Figure 12. Device current vs. P_{in} and voltage^[4,5].

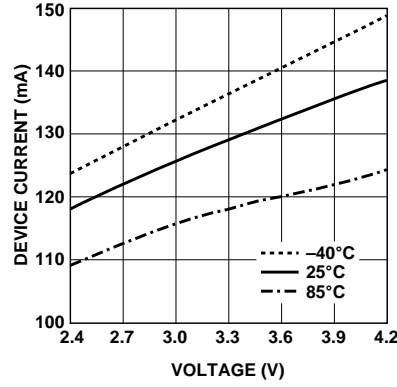

Figure 13. I_d vs. voltage and temperature (no RF drive).

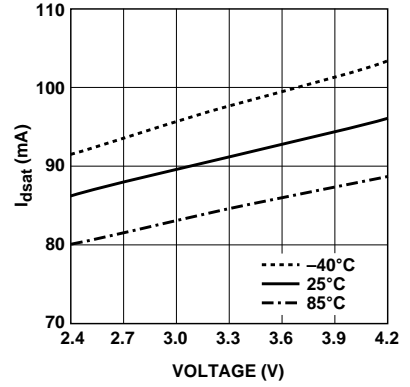

Figure 14. Saturated I_d vs. voltage and temperature^[3,4].

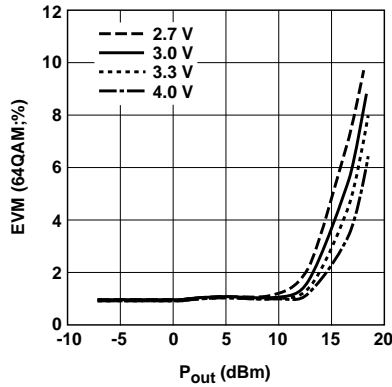

Figure 15. EVM(64QAM) vs. P_{out} and voltage at 5.725 GHz^[4].

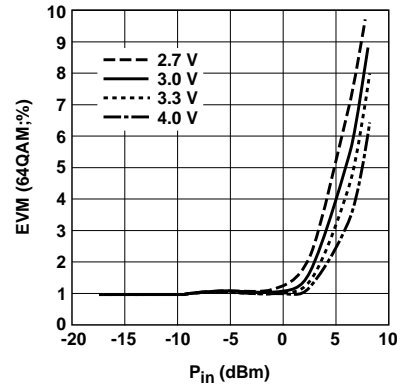

Figure 16. EVM(64QAM) vs. P_{in} and voltage at 5.725 GHz^[4].

Notes:

1. Measurement was done in a 50 Ω microstrip line with input and output tuned for maximum gain using double stub-tuners.
2. Measurement was done in a 50 Ω microstrip line with input tuned for gain and output tuned for maximum P_{sat} using double-stub tuners.
3. Measured at 2.5 dB gain compression.
4. Measurement at 5.825 GHz were made on a fixed tuned demo board that was tuned for maximum saturated output power and maximum gain.
5. Circuit losses have been de-embedded from actual measurement.

MGA-545P8 Typical Scattering Parameters
Tc = 25°C, Vd = 3.3 V, Zo = 50 Ω

| Freq. GHz | S11 | | S21 | | | S12 | | | S22 | | K |
|--------------|------|--------|-------|-------|--------|-------|-------|--------|------|--------|--------|
| | Mag | Ang | dB | Mag | Ang | dB | Mag | Ang | Mag | Ang | Factor |
| 0.1 | 0.11 | -140.5 | 24.3 | 16.33 | 169.7 | -31.9 | 0.025 | 0.0 | 0.04 | 3.9 | 1.40 |
| 0.2 | 0.17 | -132.4 | 24.0 | 15.85 | 160.1 | -31.9 | 0.025 | -0.7 | 0.04 | -1.4 | 1.40 |
| 0.3 | 0.25 | -133.4 | 23.7 | 15.34 | 151.5 | -31.9 | 0.026 | -0.6 | 0.04 | -2.7 | 1.39 |
| 0.4 | 0.30 | -137.1 | 23.3 | 14.65 | 144.1 | -31.9 | 0.025 | 1.0 | 0.04 | -4.6 | 1.40 |
| 0.5 | 0.35 | -139.0 | 22.9 | 13.96 | 136.5 | -31.8 | 0.026 | 2.4 | 0.06 | -10.5 | 1.40 |
| 0.6 | 0.40 | -144.4 | 22.4 | 13.26 | 131.2 | -31.8 | 0.026 | 3.7 | 0.07 | -13.2 | 1.38 |
| 0.7 | 0.44 | -149.7 | 21.9 | 12.51 | 124.6 | -31.8 | 0.026 | 4.7 | 0.07 | -17.5 | 1.39 |
| 0.8 | 0.47 | -153.9 | 21.4 | 11.80 | 119.2 | -31.6 | 0.026 | 5.8 | 0.07 | -22.9 | 1.38 |
| 0.9 | 0.50 | -158.5 | 20.9 | 11.11 | 113.9 | -31.6 | 0.026 | 7.2 | 0.07 | -28.3 | 1.40 |
| 1.0 | 0.52 | -162.8 | 20.4 | 10.51 | 109.3 | -31.4 | 0.027 | 7.8 | 0.08 | -31.7 | 1.40 |
| 1.5 | 0.59 | 179.0 | 18.2 | 8.09 | 89.5 | -30.6 | 0.029 | 13.2 | 0.10 | -48.5 | 1.42 |
| 1.9 | 0.61 | 166.5 | 16.7 | 6.81 | 78.0 | -29.9 | 0.032 | 15.6 | 0.11 | -60.5 | 1.45 |
| 2.0 | 0.62 | 163.8 | 16.2 | 6.47 | 75.8 | -29.7 | 0.033 | 16.2 | 0.11 | -67.5 | 1.49 |
| 2.4 | 0.61 | 153.8 | 14.9 | 5.58 | 65.4 | -28.9 | 0.036 | 18.2 | 0.12 | -73.8 | 1.56 |
| 3.0 | 0.62 | 139.3 | 13.5 | 4.71 | 53.0 | -27.6 | 0.042 | 17.6 | 0.14 | -74.6 | 1.54 |
| 4.0 | 0.54 | 116.5 | 11.9 | 3.95 | 28.6 | -25.5 | 0.053 | 10.8 | 0.19 | -89.2 | 1.63 |
| 5.0 | 0.38 | 87.9 | 11.4 | 3.70 | 0.5 | -23.5 | 0.067 | -6.5 | 0.23 | -98.4 | 1.68 |
| 5.1 | 0.34 | 83.6 | 11.3 | 3.67 | -3.4 | -23.4 | 0.068 | -9.5 | 0.24 | -99.5 | 1.71 |
| 5.2 | 0.30 | 79.2 | 11.3 | 3.66 | -7.2 | -23.3 | 0.069 | -12.3 | 0.25 | -100.6 | 1.75 |
| 5.3 | 0.26 | 75.1 | 11.2 | 3.62 | -11.1 | -23.2 | 0.069 | -16.3 | 0.26 | -101.8 | 1.80 |
| 5.4 | 0.21 | 70.9 | 11.1 | 3.61 | -15.5 | -23.1 | 0.070 | -18.8 | 0.27 | -103.9 | 1.83 |
| 5.5 | 0.15 | 71.0 | 11.1 | 3.59 | -19.6 | -23.1 | 0.070 | -22.9 | 0.28 | -106.9 | 1.88 |
| 5.6 | 0.11 | 82.8 | 10.9 | 3.53 | -23.0 | -23.0 | 0.071 | -25.6 | 0.29 | -108.7 | 1.91 |
| 5.7 | 0.08 | 99.7 | 10.9 | 3.51 | -26.0 | -22.9 | 0.072 | -27.7 | 0.29 | -109.9 | 1.91 |
| 5.8 | 0.06 | 115.1 | 10.9 | 3.49 | -29.2 | -22.8 | 0.073 | -30.4 | 0.30 | -108.9 | 1.91 |
| 5.9 | 0.06 | 161.8 | 10.8 | 3.48 | -33.2 | -22.9 | 0.072 | -33.4 | 0.34 | -109.1 | 1.90 |
| 6.0 | 0.10 | -161.5 | 10.8 | 3.46 | -39.1 | -23.0 | 0.071 | -38.4 | 0.36 | -118.8 | 1.91 |
| 6.5 | 0.43 | -166.1 | 9.7 | 3.05 | -71.8 | -25.4 | 0.054 | -70.7 | 0.47 | -136.8 | 2.20 |
| 7.0 | 0.69 | 165.0 | 6.2 | 2.05 | -104.8 | -32.3 | 0.024 | -106.7 | 0.50 | -157.6 | 4.22 |
| 8.0 | 0.87 | 117.4 | -3.7 | 0.66 | -149.2 | -33.2 | 0.022 | 55.7 | 0.46 | 172.0 | 6.38 |
| 9.0 | 0.91 | 97.6 | -19.0 | 0.11 | -172.2 | -26.8 | 0.046 | 38.8 | 0.42 | 156.3 | 13.14 |
| 10.0 | 0.93 | 77.7 | -19.3 | 0.11 | -6.4 | -23.9 | 0.064 | 18.8 | 0.41 | 143.1 | 8.26 |
| 11.0 | 0.90 | 63.6 | -14.1 | 0.20 | -20.6 | -22.9 | 0.072 | 8.2 | 0.40 | 129.3 | 5.90 |
| 12.0 | 0.95 | 50.7 | -12.1 | 0.25 | -38.3 | -21.8 | 0.081 | -5.1 | 0.42 | 117.2 | 2.17 |
| 13.0 | 0.96 | 41.1 | -12.2 | 0.25 | -54.0 | -21.4 | 0.085 | -15.7 | 0.46 | 102.6 | 1.72 |
| 14.0 | 0.93 | 30.7 | -12.4 | 0.24 | -59.4 | -21.1 | 0.088 | -25.2 | 0.49 | 87.6 | 3.00 |
| 15.0 | 0.91 | 27.9 | -13.1 | 0.22 | -66.6 | -20.6 | 0.093 | -29.4 | 0.53 | 80.2 | 3.56 |
| 16.0 | 0.96 | 22.0 | -12.9 | 0.23 | -79.5 | -20.4 | 0.096 | -40.0 | 0.57 | 70.3 | 1.74 |
| 17.0 | 0.95 | 14.4 | -13.6 | 0.21 | -88.3 | -19.8 | 0.103 | -44.6 | 0.61 | 62.9 | 1.84 |
| 18.0 | 0.96 | 8.0 | -13.6 | 0.21 | -88.0 | -19.1 | 0.111 | -56.1 | 0.62 | 50.3 | 1.55 |

MGA-545P8 Typical Noise Parameters at $T_c = 25^\circ\text{C}$, $V_d = 3.3\text{ V}$

| Frequency GHz | Fmin dB | Gopt | | Rn/50 Ω |
|------------------|------------|------|------|----------------|
| | | Mag | Ang | |
| 1.0 | 2.1 | 0.46 | -144 | 0.15 |
| 2.0 | 2.4 | 0.44 | -133 | 0.20 |
| 3.0 | 2.5 | 0.44 | -123 | 0.27 |
| 4.0 | 2.9 | 0.39 | -100 | 0.43 |
| 5.0 | 3.2 | 0.26 | -77 | 0.51 |
| 6.0 | 3.5 | 0.13 | -77 | 0.48 |
| 7.0 | 4.4 | 0.38 | -158 | 0.28 |

Device Models

Refer to Agilent's Web Site
www.agilent.com/view/rf

Ordering Information

| Part Number | No. of Devices | Container |
|---------------|----------------|----------------|
| MGA-545P8-TR1 | 3000 | 7" Reel |
| MGA-545P8-TR2 | 10000 | 13" Reel |
| MGA-545P8-BLK | 100 | Antistatic Bag |

2x2 LPCC (JEDEC DFP_N) Package Dimensions

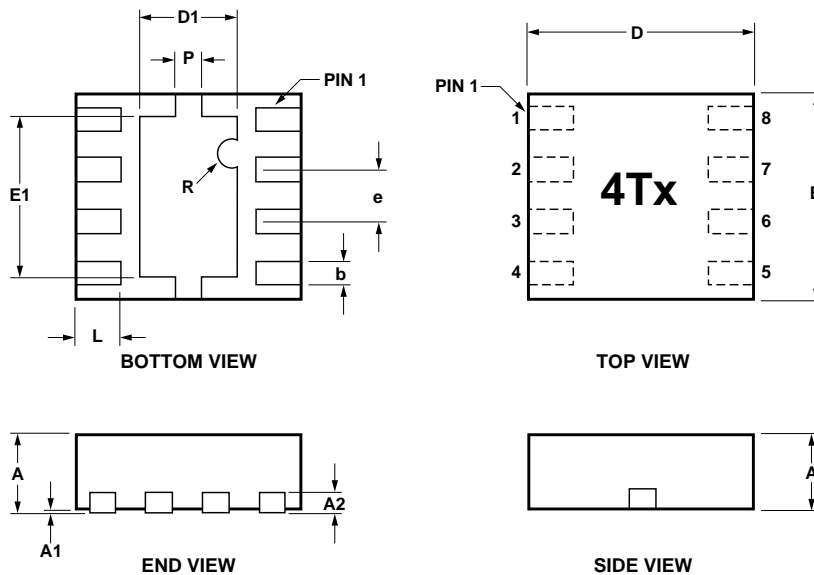

| SYMBOL | DIMENSIONS | | |
|--------|------------|-----------|-------|
| | MIN. | NOM. | MAX. |
| A | 0.7 | 0.75 | 0.8 |
| A1 | 0 | 0.02 | 0.05 |
| A2 | | 0.203 REF | |
| b | 0.225 | 0.25 | 0.275 |
| D | 1.9 | 2 | 2.1 |
| D1 | 0.65 | 0.8 | 0.95 |
| E | 1.9 | 2 | 2.1 |
| E1 | 1.45 | 1.6 | 1.75 |
| e | | 0.50 BSC | |
| P | 0.20 | 0.25 | 0.30 |
| L | 0.35 | 0.40 | 0.45 |

PCB Land Pattern and Stencil Design

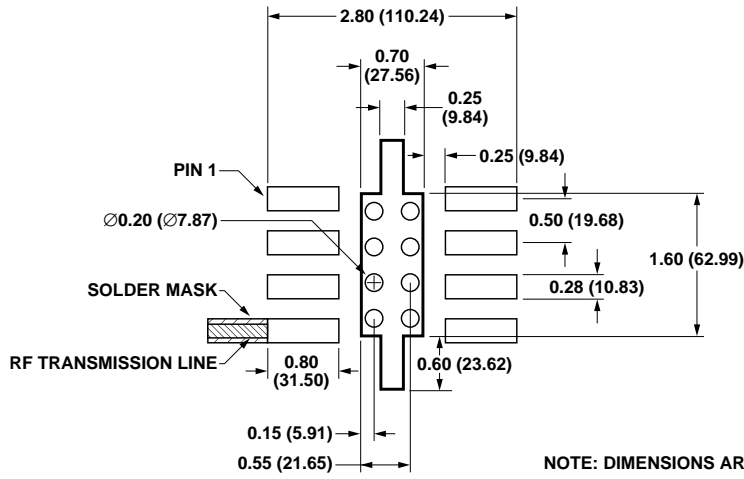

PCB LAND PATTERN (TOP VIEW)

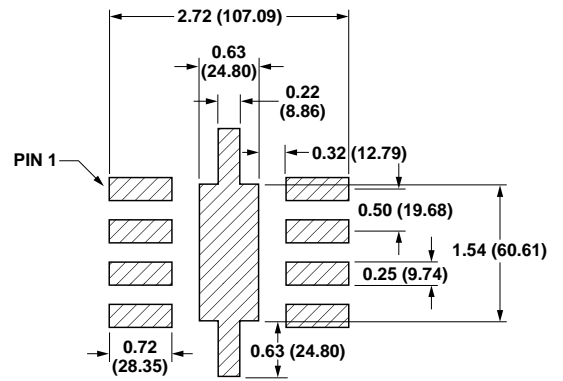

STENCIL LAYOUT (TOP VIEW)

Device Orientation

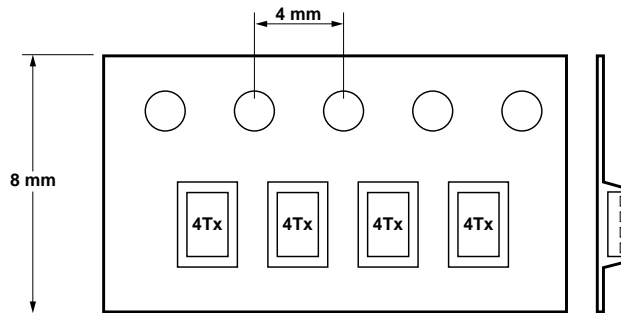
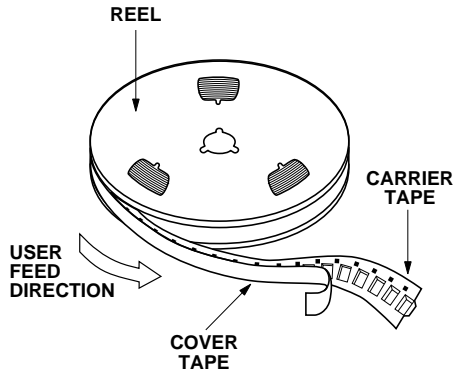

Tape Dimensions

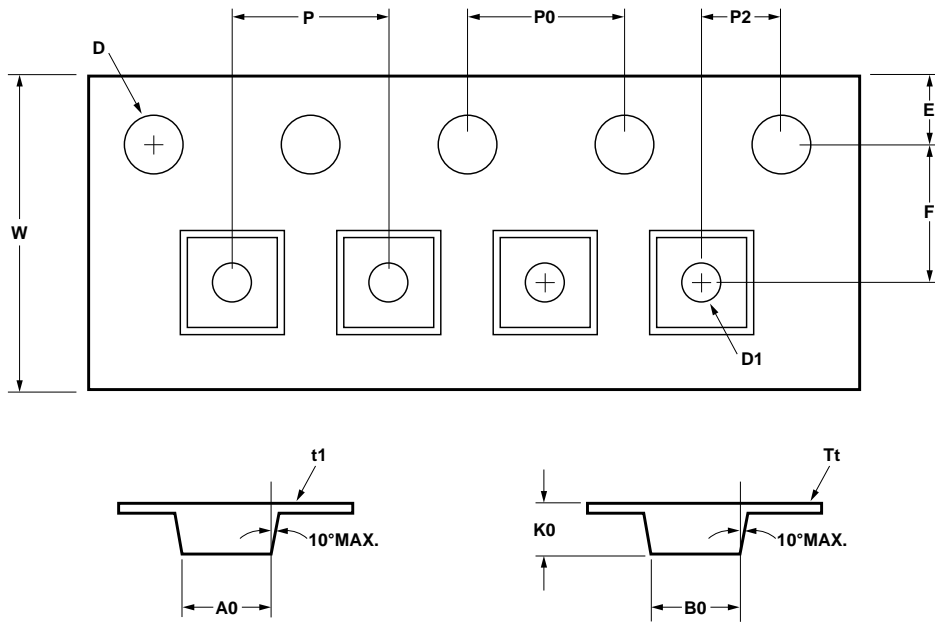

| DESCRIPTION | | SYMBOL | SIZE (mm) | SIZE (INCH) |
|--------------|--|--------|--------------------------------|--|
| CAVITY | LENGTH | A_0 | 2.30 ± 0.05 | 0.091 ± 0.004 |
| | WIDTH | B_0 | 2.30 ± 0.05 | 0.091 ± 0.004 |
| | DEPTH | K_0 | 1.00 ± 0.05 | 0.039 ± 0.002 |
| | PITCH | P | 4.00 ± 0.10 | 0.157 ± 0.004 |
| | BOTTOM HOLE DIAMETER | D_1 | 1.00 ± 0.25 | 0.039 ± 0.002 |
| PERFORATION | DIAMETER | D | 1.50 ± 0.10 | 0.060 ± 0.004 |
| | PITCH | P_0 | 4.00 ± 0.10 | 0.157 ± 0.004 |
| | POSITION | E | 1.75 ± 0.10 | 0.069 ± 0.004 |
| CARRIER TAPE | WIDTH | W | $8.00 + 0.30$ $8.00 - 0.10$ | 0.315 ± 0.012 0.315 ± 0.004 |
| | THICKNESS | t_1 | 0.254 ± 0.02 | 0.010 ± 0.0008 |
| COVER TAPE | WIDTH | C | 5.4 ± 0.10 | 0.205 ± 0.004 |
| | TAPE THICKNESS | T_t | 0.062 ± 0.001 | 0.0025 ± 0.0004 |
| DISTANCE | CAVITY TO PERFORATION (WIDTH DIRECTION) | F | 3.50 ± 0.05 | 0.138 ± 0.002 |
| | CAVITY TO PERFORATION (LENGTH DIRECTION) | P_2 | 2.00 ± 0.05 | 0.079 ± 0.002 |

www.agilent.com/semiconductors

For product information and a complete list of distributors, please go to our web site.

For technical assistance call:

Americas/Canada: +1 (800) 235-0312 or
(408) 654-8675

Europe: +49 (0) 6441 92460

China: 10800 650 0017

Hong Kong: (+65) 6271 2451

India, Australia, New Zealand: (+65) 6271 2394

Japan: (+81 3) 3335-8152(Domestic/International), or 0120-61-1280(Domestic Only)

Korea: (+65) 6271 2194

Malaysia, Singapore: (+65) 6271 2054

Taiwan: (+65) 6271 2654

Data subject to change.

Copyright © 2003 Agilent Technologies, Inc.

January 10, 2003

5988-8404EN



Agilent Technologies