

Specifications

Parameter	Unit	Minimum	Typical	Maximum
Center Frequency	MHz	114.875	115	115.125
Insertion Loss	dB	-	26.8	28
3 dB Bandwidth	MHz	8	8.1	-
30 dB Bandwidth	MHz	-	8.72	8.8
Absolute Delay	us	-	4.26	4.5
Passband Variation	dB	-	1.1	2
Ultimate Rejection	dB	50	52	-
Substrate Material		LT		
Ambient Temperature	°C	25		
Package Size		DIP3512 (35.0x12.8x4.7mm ³)		

Notes:

1. All specifications are based on the test circuit shown
2. In production, devices will be tested at room temperature to a guardbanded specification to ensure electrical compliance over temperature
3. Electrical margin has been built into the design to account for the variations due to temperature drift and manufacturing tolerances
4. This is the optimum impedance in order to achieve the performance shown

Matching Configuration

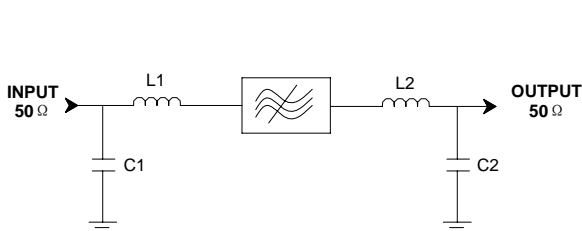

L1=56nH

L2=47nH

C1=56pF

C2=56pF

Source/Load Impedance=50 ohm

Notes - Component values may change depending on board layout.



SIPAT Co., Ltd.
(CETC No. 26 Research Institute)
Nanping Huayuan Road No. 14
Chongqing, China, 400060

Part Number	SP LBT11522	
Rev. Date	2004-10-10	
Rev.	1.0	Page 1/3

Package Dimension

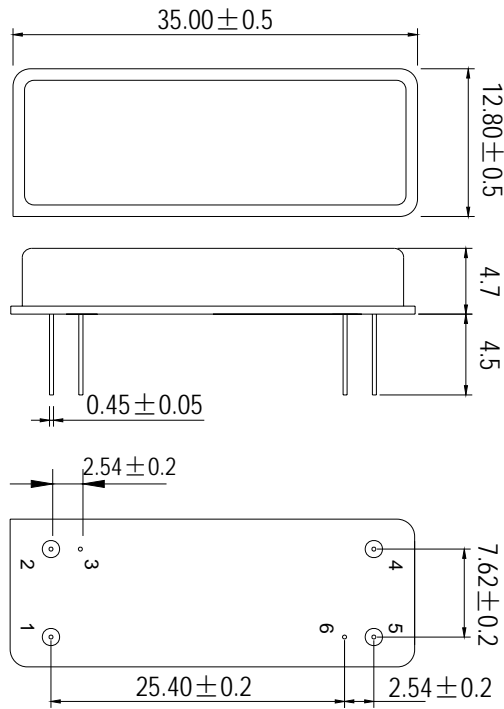

SIPAT Co., Ltd.
(CETC No. 26 Research Institute)
Nanping Huayuan Road No. 14
Chongqing, China, 400060

Part Number	SP LBT11522	
Rev. Date	2004-10-10	
Rev.	1.0	Page 2/3

Typical Performance

Frequency Respond

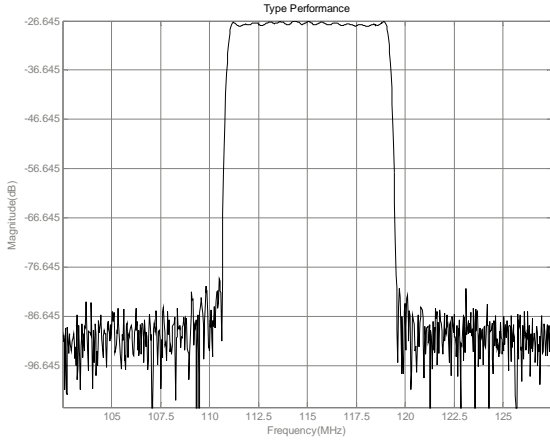

Passband Respond

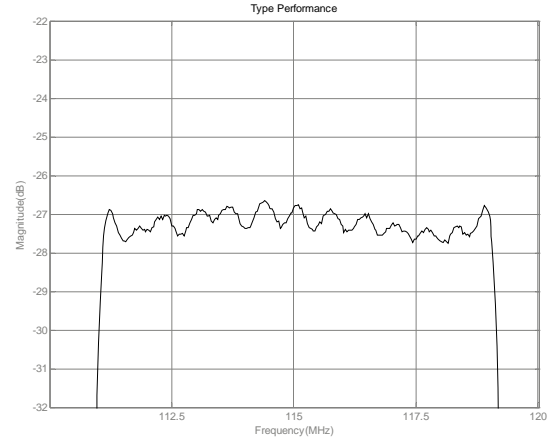

Wideband Respond

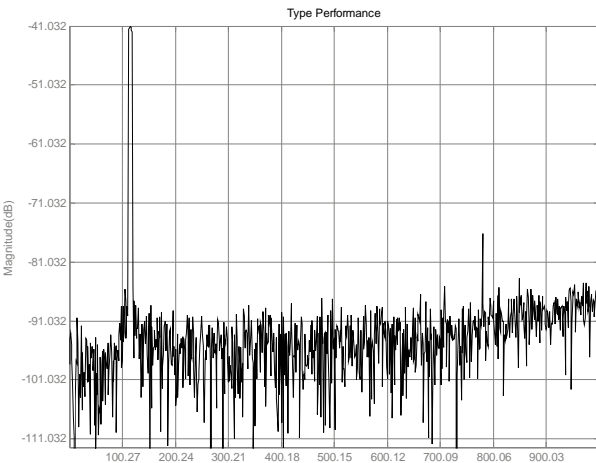

Phase Linearity

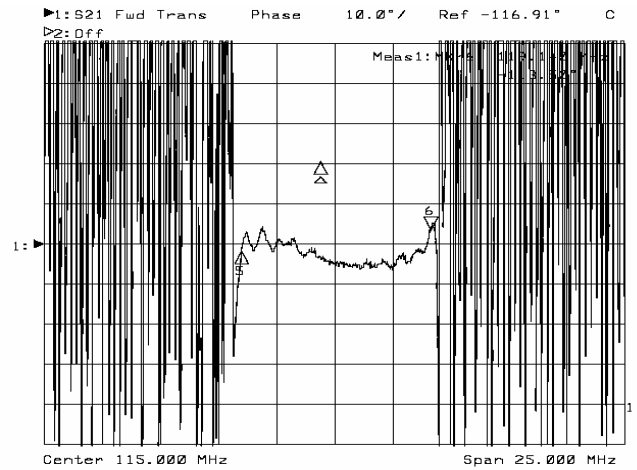

Smith Chart S11

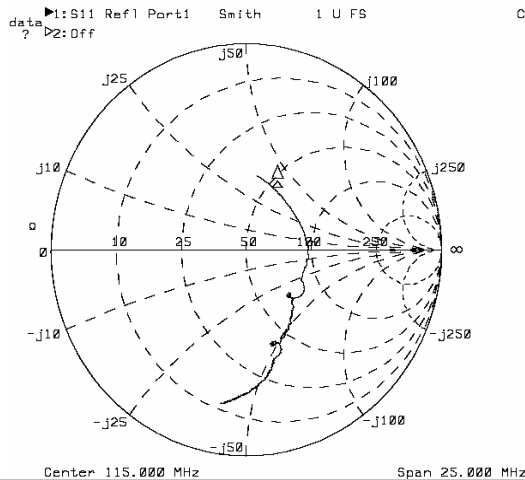

Smith Chart S22

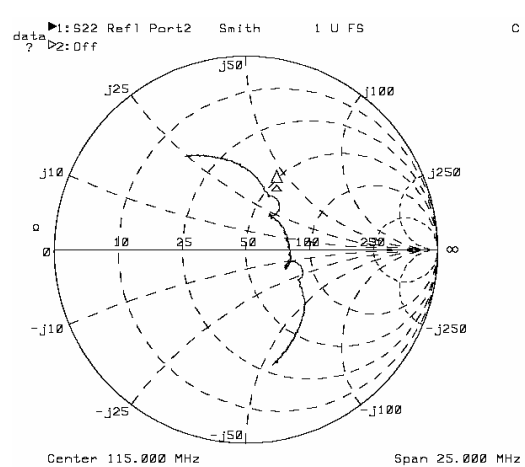

SIPAT Co., Ltd.
(CETC No. 26 Research Institute)
Nanping Huayuan Road No. 14
Chongqing, China, 400060

Part Number

SP LBT11522

Rev. Date

2004-10-10

Rev.

1.0

Page 3/3