

USR UNR 4-3425 3825 3825H 4020

Precision Shunt Resistors

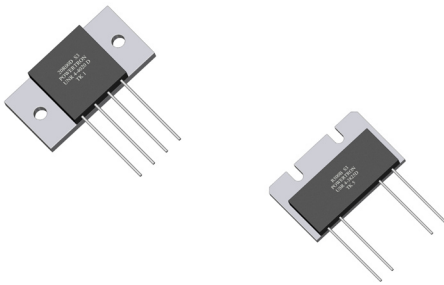

- Resistances from 0.05Ohm to 500Ohms
- Power Rating to 50Watt
- Resistance Tolerances to $\pm 0.01\%$
- TCR to $\pm 1\text{ppm/K}$
- Load Stability to 0.01%

SPECIFICATIONS

Type	USR 4-3425 3825	USR 4-4020	UNR 4-3425 3825	UNR 4-4020
Resistance Range	0.05 to 500 Ohms other resistance values upon request / power rating depending on resistance value			0.05 to 400 Ohms
Power rating free air 70°C for 3825H with heatsink	3 W 5 W 30 W	2.5 W 30 W	3 W 5 W 50 W	2.5 W 50 W
Thermal Resistance Rthj-c	3.5 K/W	3.6 K/W	2.1 K/W	2.2 K/W
Tolerances from 0.05 Ohms from 10.0 Ohms from 50.0 Ohms	0.1% / 0.25% / 0.5% / 1% 0.05% / 0.1% / 0.25% / 0.5% / 1% 0.01% / 0.02% / 0.05% / 0.1% / 0.25% / 0.5% / 1%			
Stability	0.01%			
Shelf Life Stability	25ppm / ΔR after 1 year 50ppm / ΔR after 3 year			
Temperature Coefficient	max. $\pm 5\text{ppm/K}$ (-55 to 155°C) typ. $\pm 3\text{ppm/K}$ (-55 to 125°C) upon request $\pm 1\text{ppm/K}$ (0 to 60°C)			
Voltage Proof	750 VDC			
max. Current	15 A			
Thermal EMF	< 0.1 $\mu\text{V/K}$			
Operating Temperature Range	-55 to 155°C			
Resistor Material	NiCr-Foil			
Substrate	Al ₂ O ₃		AlN	
Housing	Epoxy + Al-heatsink			
Connector Material	Cu tinned			
Terminals	4			
Max. Torque	1.0 Nm			
Notes	Specially designed for applications with fast changing electrical load			

Ordering Information

Part Number - Resistance - Contact - Tolerance - TCR
 USR 4-3825H 10Ohms D 0.5% 3ppm

SPECIFICATIONS (continued)

Temperature Coefficient

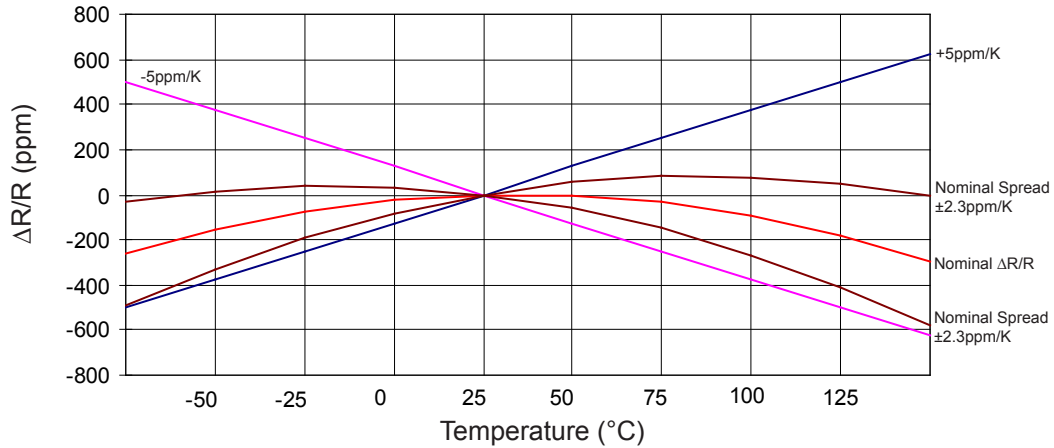

Derating

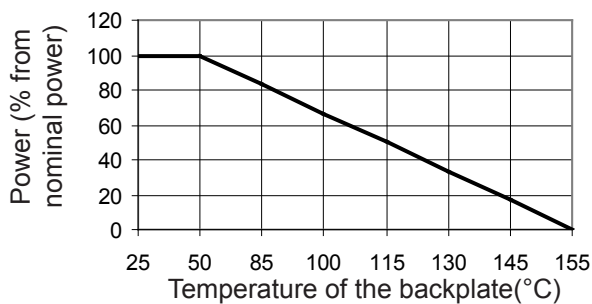

Power Rating Notes -

The U-Series Resistors must be attached to a suitable heatsink. The maximum internal resistor temperature is 155°C. To specify an appropriate heatsink use the following formula :

$$R_{0H} = \frac{T_{MAX} - (P \times R_{0R}) - T_A}{P}$$

Where: R_{0H} = Thermal Resistance of Heatsink (K/W)
 R_{0R} = Thermal Resistance of Resistor (K/W)
 T_{MAX} = Maximum Temperature of Resistor
 T_A = Ambient Temperature of Heatsink (°C)
 P = Power Through Resistor (W)

Dimensions

USR 4-3425 / UNR 4-3425

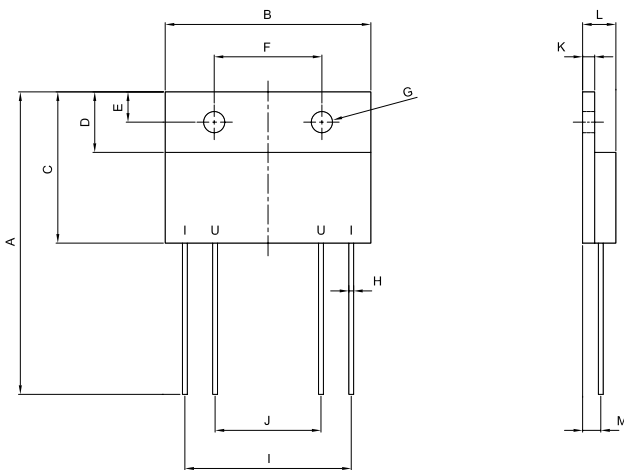

Dimension	mm	tol. (±mm)	inches	tol. (±inches)
A	50.00	2.0	1.97	0.079
B	34.00	0.3	1.34	0.012
C	25.00	0.2	0.98	0.008
D	10.00	0.2	0.39	0.008
E	5.00	0.1	0.20	0.004
F	17.80	0.2	0.70	0.008
G	∅3.50	0.1	∅0.14	0.004
H	∅0.8	0.1	∅0.031	0.004
I	27.50	0.2	1.08	0.008
J	17.50	0.2	0.69	0.008
K	2.00	0.1	0.08	0.004
L	5.50	0.1	0.22	0.004
M	3.00	0.2	0.12	0.008

SPECIFICATIONS (continued)

USR 4-3825 / UNR 4-3825

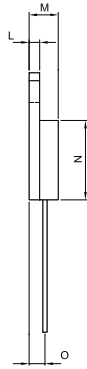
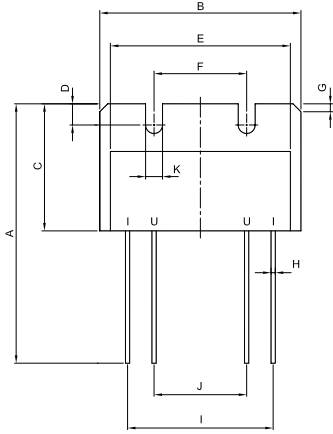

Dimension	mm	tol. (±mm)	inches	tol. (±inches)
A	49.00	2.0	1.93	0.079
B	38.00	0.3	1.50	0.012
C	24.00	0.2	0.94	0.008
D	4.00	0.1	0.16	0.004
E	34.00	0.3	1.34	0.012
F	17.50	0.2	0.69	0.008
G	1.5x45°	0.1	0.6x45°	0.004
H	∅0.8	0.1	∅0.031	0.004
I	27.50	0.2	1.08	0.008
J	17.50	0.2	0.69	0.008
K	∅3.2	0.1	∅0.126	0.004
L	2.00	0.1	0.08	0.004
M	5.50	0.1	0.22	0.004
N	15.00	0.2	0.59	0.008
O	3.00	0.2	0.12	0.008

USR 4-3825H / UNR 4-3825H

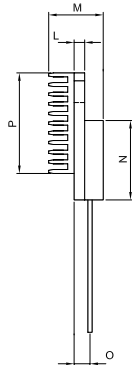
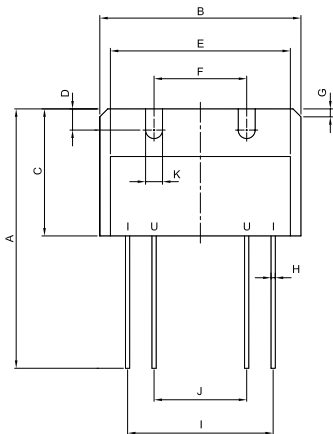

Dimension	mm	tol. (±mm)	inches	tol. (±inches)
A	49.00	2.0	1.93	0.079
B	38.00	0.3	1.50	0.012
C	24.00	0.2	0.94	0.008
D	4.00	0.1	0.16	0.004
E	34.00	0.3	1.34	0.012
F	17.50	0.2	0.69	0.008
G	1.5x45°	0.1	0.6x45°	0.004
H	∅0.8	0.1	∅0.031	0.004
I	27.50	0.2	1.08	0.008
J	17.50	0.2	0.69	0.008
K	∅3.2	0.1	∅0.126	0.004
L	2.00	0.1	0.08	0.004
M	max.10.3	0.2	max.0.4	0.008
N	15.00	0.2	0.59	0.008
O	3.00	0.2	0.12	0.008
P	19.00	0.2	0.75	0.008

USR 4-4020 / UNR 4-4020

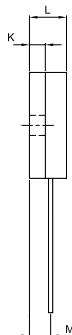
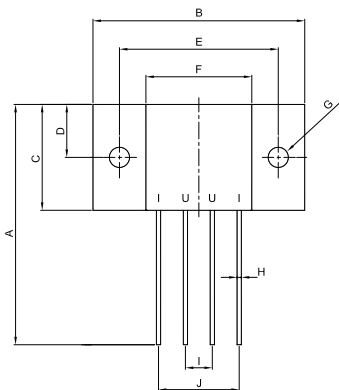

Dimension	mm	tol. (±mm)	inches	tol. (±inches)
A	45.40	2.0	1.79	0.079
B	40.00	0.3	1.57	0.012
C	20.00	0.2	0.79	0.008
D	10.00	0.2	0.39	0.008
E	30.00	0.2	1.18	0.008
F	20.00	0.2	0.79	0.008
G	∅3.80	0.1	∅0.15	0.004
H	∅0.8	0.1	∅0.031	0.004
I	5.08	0.1	0.20	0.004
J	15.24	0.2	0.60	0.008
K	3.00	0.1	0.12	0.004
L	7.00	0.1	0.28	0.004
M	4.00	0.1	0.16	0.004