



# STB12NM50FD - STB12NM50FD-1 STP12NM50FD/FP - STW14NM50FD

N-channel 500V - 0.32Ω - 12A - TO-220/FP - D<sup>2</sup>/I<sup>2</sup>PAK - TO-247  
FDmesh™ Power MOSFET (with fast diode)

## General features

Type	V <sub>DSS</sub>	R <sub>DS(on)</sub>	I <sub>D</sub>	P <sub>w</sub>
STB12NM50FD	500V	<0.4Ω	12A	160W
STB12NM50FD-1	500V	<0.4Ω	12A	160W
STP12NM50FD	500V	<0.4Ω	12A	160W
STP12NM50FD/FP	500V	<0.4Ω	12A	35W
STW14NM50FD	500V	<0.4Ω	12A	160W

- 100% avalanche tested
- High dv/dt and avalanche capabilities
- Low input capacitance and gate charge
- Low gate input resistance
- Tight process control and high manufacturing yields

## Description

The FDmesh™ associates all advantages of reduced on-resistance and fast switching with an intrinsic fast-recovery body diode. It is therefore strongly recommended for bridge topologies, in particular ZVS phase-shift converters.

## Applications

- Switching application

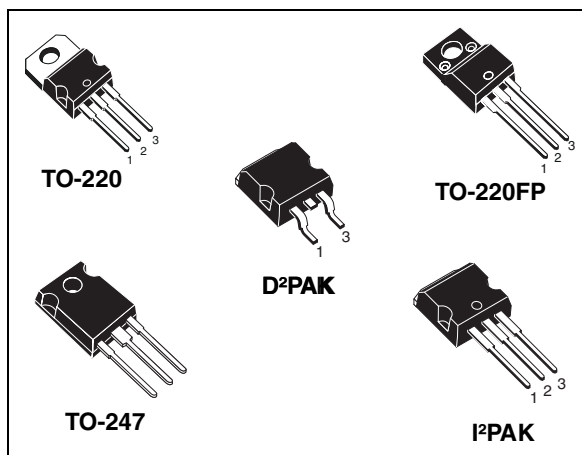

## Internal schematic diagram

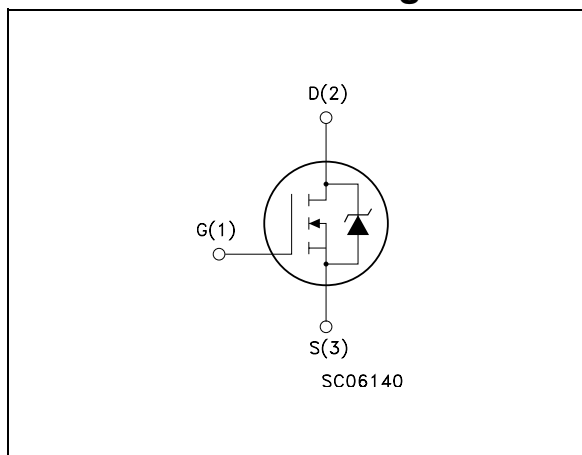

## Order codes

Part number	Marking	Package	Packaging
STB12NM50FD	B12NM50FD	D <sup>2</sup> PAK	Tape & reel
STB12NM50FD-1	B12NM50FD	I <sup>2</sup> PAK	Tube
STP12NM50FD	P12NM50FD	TO-220	Tube
STP12NM50FD/FP	P12NM50FD/FP	TO-220FP	Tube
STW14NM50FD	W14NM50FD	TO-247	Tube

## Contents

<b>1</b>	<b>Electrical ratings</b> .....	<b>3</b>
<b>2</b>	<b>Electrical characteristics</b> .....	<b>5</b>
2.1	Electrical characteristics (curves) .....	6
<b>3</b>	<b>Test circuit</b> .....	<b>10</b>
<b>4</b>	<b>Package mechanical data</b> .....	<b>11</b>
<b>5</b>	<b>Packaging mechanical data</b> .....	<b>17</b>
<b>6</b>	<b>Revision history</b> .....	<b>18</b>

# 1 Electrical ratings

**Table 1. Absolute maximum ratings**

Symbol	Parameter	Value			Unit
		TO-220/ D <sup>2</sup> /I <sup>2</sup> PAK	TO-220FP	TO-247	
V <sub>DS</sub>	Drain-source voltage (V <sub>GS</sub> = 0)	500			V
V <sub>DGR</sub>	Drain-gate voltage (R <sub>GS</sub> = 20KΩ)	500			V
V <sub>GS</sub>	Gate-source voltage	± 30			V
I <sub>D</sub>	Drain current (continuous) at T <sub>C</sub> = 25°C	12	12 <sup>(1)</sup>	14	A
I <sub>D</sub>	Drain current (continuous) at T <sub>C</sub> =100°C	7.5	7.5 <sup>(1)</sup>	8.8	A
I <sub>DM</sub> <sup>(2)</sup>	Drain current (pulsed)	48	48 <sup>(1)</sup>	56	A
P <sub>TOT</sub>	Total dissipation at T <sub>C</sub> = 25°C	160	35	160	W
	Derating factor	1.28	0.28	1.4	W/°C
dv/dt <sup>(3)</sup>	Peak diode recovery voltage slope	20			V/ns
V <sub>ISO</sub>	Insulation withstand voltage (DC)	--	2500	--	V
T <sub>J</sub> T <sub>stg</sub>	Operating junction temperature Storage temperature	-65 to 150			°C

- Limited only by maximum temperature allowed
- Pulse width limited by safe operating area
- I<sub>SD</sub> ≤ 2A, di/dt ≤ 400A/μs, V<sub>DD</sub> = 80%V<sub>(BR)DSS</sub>

**Table 2. Thermal resistance**

Symbol	Parameter	Value				Unit
		TO-220 I <sup>2</sup> PAK	D <sup>2</sup> PAK	TO-220FP	TO-247	
R <sub>thj-case</sub>	Thermal resistance junction-case Max	0.78		3.57	0.77	°C/W
R <sub>thj-a</sub>	Thermal resistance junction-ambient Max	62.5	100	62.5		°C/W
T <sub>I</sub>	Maximum lead temperature for soldering purpose	300				°C

**Table 3. Avalanche data**

Symbol	Parameter	Value	Unit
I <sub>AR</sub>	Avalanche current, repetitive or not-repetitive (pulse width limited by T <sub>J</sub> Max)	6	A
E <sub>AS</sub>	Single pulse avalanche energy (starting T <sub>J</sub> =25°C, I <sub>d</sub> =I <sub>ar</sub> , V <sub>dd</sub> =50V)	400	mJ

## 2 Electrical characteristics

( $T_{CASE}=25^{\circ}C$  unless otherwise specified)

**Table 4. On/off states**

Symbol	Parameter	Test conditions	Min.	Typ.	Max.	Unit
$V_{(BR)DSS}$	Drain-source breakdown voltage	$I_D = 1mA, V_{GS} = 0$	500			V
$I_{DSS}$	Zero gate voltage drain current ( $V_{GS} = 0$ )	$V_{DS} = \text{Max rating},$ $V_{DS} = \text{Max rating @ } 125^{\circ}C$			1 10	$\mu A$ $\mu A$
$I_{GSS}$	Gate body leakage current ( $V_{DS} = 0$ )	$V_{GS} = \pm 30V$			$\pm 100$	nA
$V_{GS(th)}$	Gate threshold voltage	$V_{DS} = V_{GS}, I_D = 250\mu A$	3	4	5	V
$R_{DS(on)}$	Static drain-source on resistance	$V_{GS} = 10V, I_D = 6A$		0.32	0.4	$\Omega$

**Table 5. Dynamic**

Symbol	Parameter	Test conditions	Min.	Typ.	Max.	Unit
$g_{fs}^{(1)}$	Forward transconductance	$V_{DS} = 15V, I_D = 6A$		9.8		S
$C_{iss}$	Input capacitance	$V_{DS} = 25V, f = 1 \text{ MHz},$ $V_{GS} = 0$		1000		pF
$C_{oss}$	Output capacitance			390		pF
$C_{rss}$	Reverse transfer capacitance			20		pF
$Q_g$	Total gate charge	$V_{DD} = 400V, I_D = 3A$ $V_{GS} = 10V$ (see Figure 11)		12		nC
$Q_{gs}$	Gate-source charge			3		nC
$Q_{gd}$	Gate-drain charge			7		nC
$R_G$	Gate input resistance	$f = 1 \text{ MHz}$ Gate DC Bias = 0 test signal level = 20mV open drain		2		$\Omega$

1. Pulsed: pulse duration=300 $\mu s$ , duty cycle 1.5%

**Table 6. Switching times**

Symbol	Parameter	Test Conditions	Min.	Typ.	Max.	Unit
$t_{d(on)}$	Turn-on delay time	$V_{DD}=250\text{ V}$ , $I_D=6\text{ A}$ , $R_G=4.7\Omega$ , $V_{GS}=10\text{ V}$ (see Figure 17)		19		ns
$t_r$	Rise time			10		ns
$t_{r(Voff)}$	Off-voltage rise time	$V_{DD}=400\text{ V}$ , $I_D=12\text{ A}$ , $R_G=4.7\Omega$ , $V_{GS}=10\text{ V}$ (see Figure 17)		39		ns
$t_f$	Fall time			18		ns
$t_c$	Cross-over time			29		ns

**Table 7. Source drain diode**

Symbol	Parameter	Test conditions	Min	Typ.	Max	Unit
$I_{SD}$	Source-drain current				12	A
$I_{SDM}^{(1)}$	Source-drain current (pulsed)				48	A
$V_{SD}^{(2)}$	Forward on voltage	$I_{SD}=12\text{ A}$ , $V_{GS}=0$			1.5	V
$t_{rr}$	Reverse recovery time	$I_{SD}=12\text{ A}$ , $T_j=25^\circ\text{C}$ $di/dt = 100\text{ A}/\mu\text{s}$ , $V_{DD}=30\text{ V}$ , (see Figure 22)		140		ns
$Q_{rr}$	Reverse recovery charge			800		nC
$I_{RRM}$	Reverse recovery current			11		A
$t_{rr}$	Reverse recovery time	$I_{SD}=12\text{ A}$ , $T_j=150^\circ\text{C}$ $di/dt = 100\text{ A}/\mu\text{s}$ , $V_{DD}=30\text{ V}$ , (see Figure 22)		252		ns
$Q_{rr}$	Reverse recovery charge			1890		nC
$I_{RRM}$	Reverse recovery current			15		A

1. Pulse width limited by safe operating area
2. Pulsed: pulse duration=300 $\mu\text{s}$ , duty cycle 1.5%

## 2.1 Electrical characteristics (curves)

Figure 1. Safe operating area for TO-220/D<sup>2</sup>PAK/I<sup>2</sup>PAK

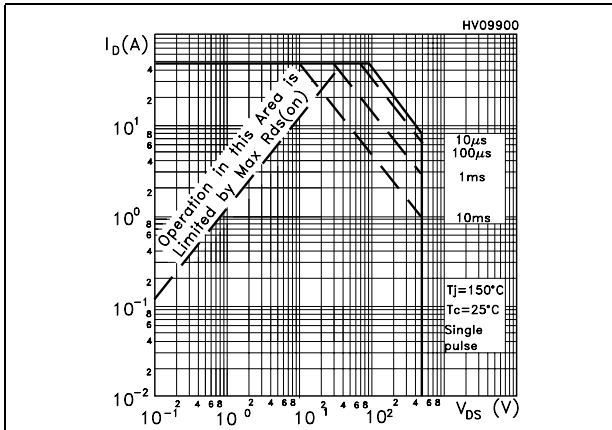

Figure 2. Thermal impedance for TO-220/D<sup>2</sup>PAK/I<sup>2</sup>PAK

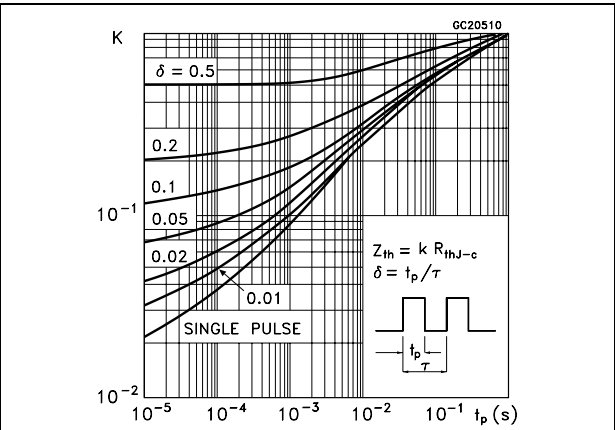

Figure 3. Safe operating area for TO-220FP

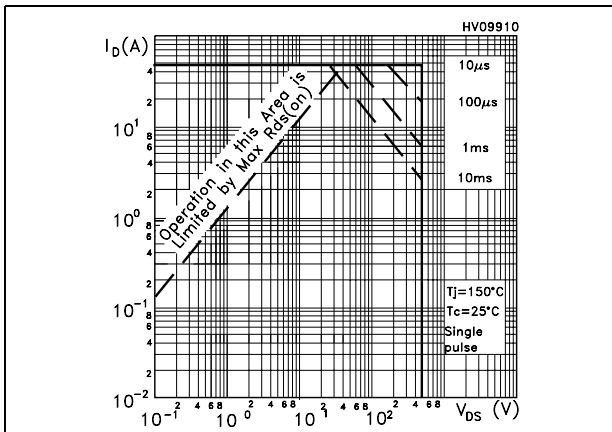

Figure 4. Thermal impedance for TO-220FP

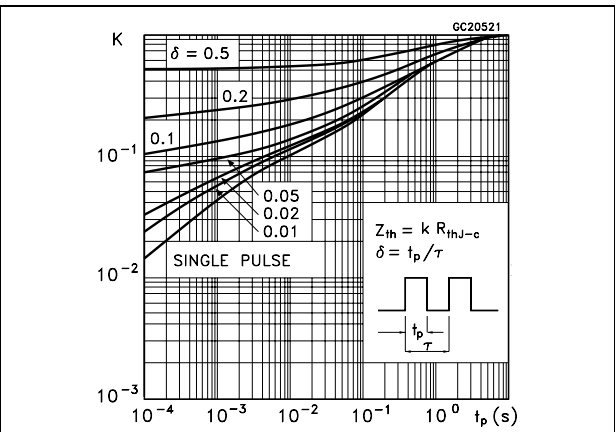

Figure 5. Safe operating area for TO-247

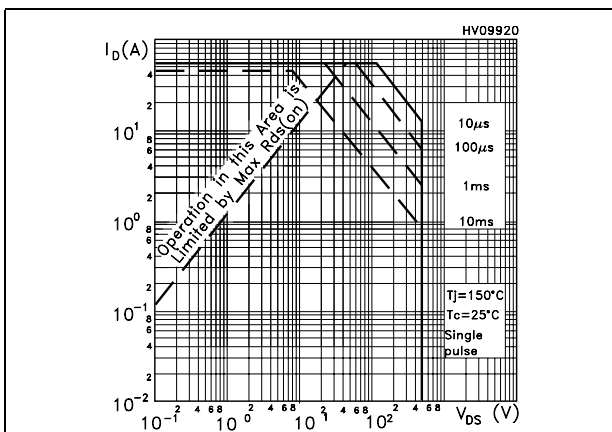

Figure 6. Thermal impedance for TO-247

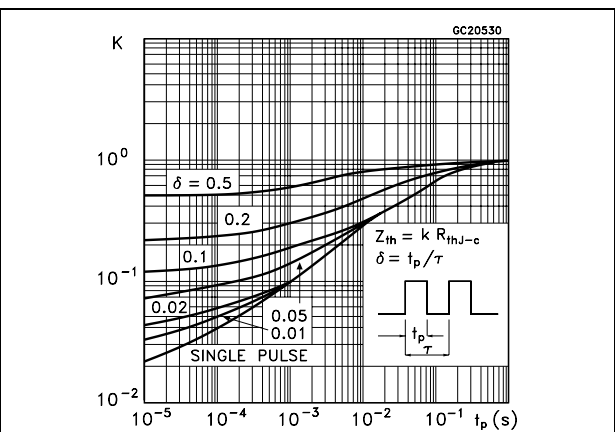

Figure 7. Output characteristics

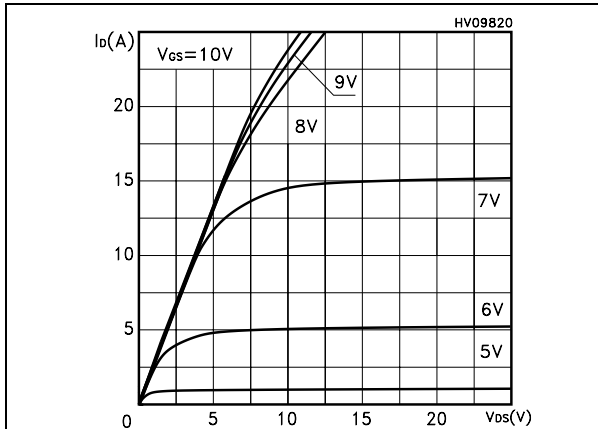

Figure 8. Transfer characteristics

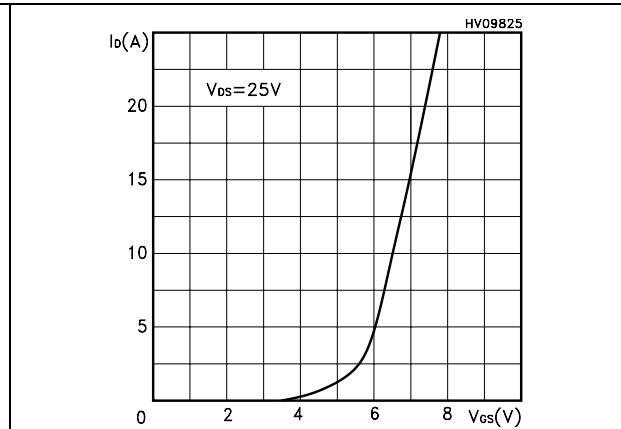

Figure 9. Transconductance

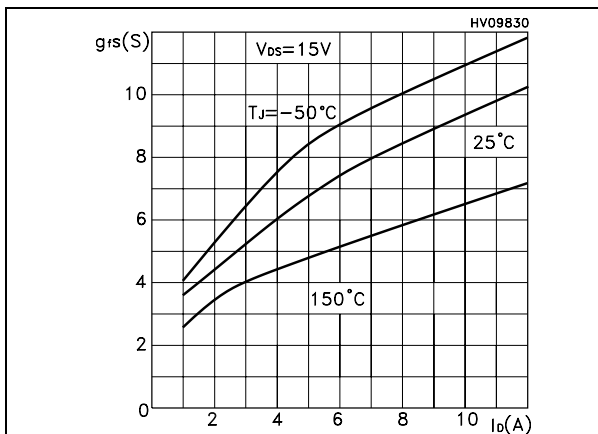

Figure 10. Static drain-source on resistance

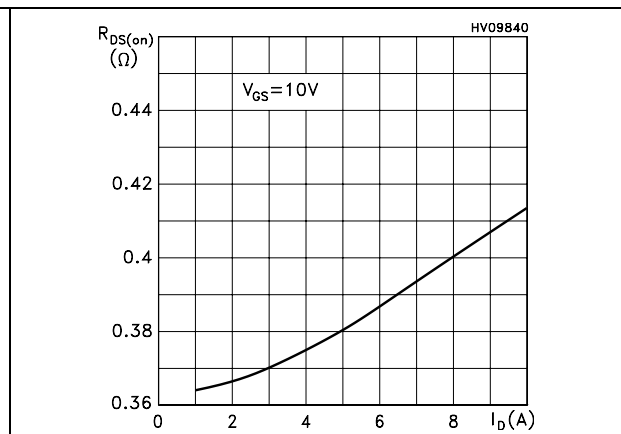

Figure 11. Gate charge vs gate-source voltage Figure 12. Capacitance variations

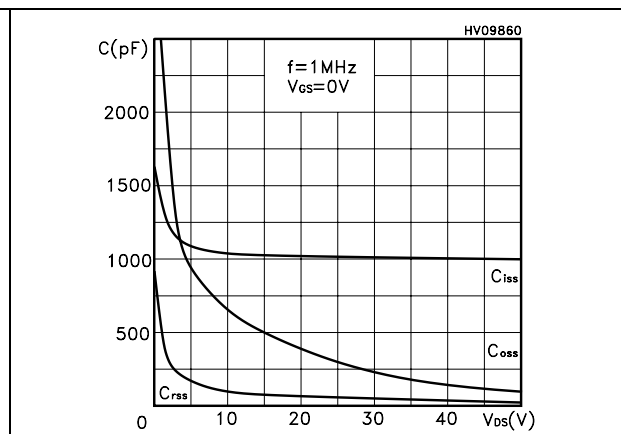
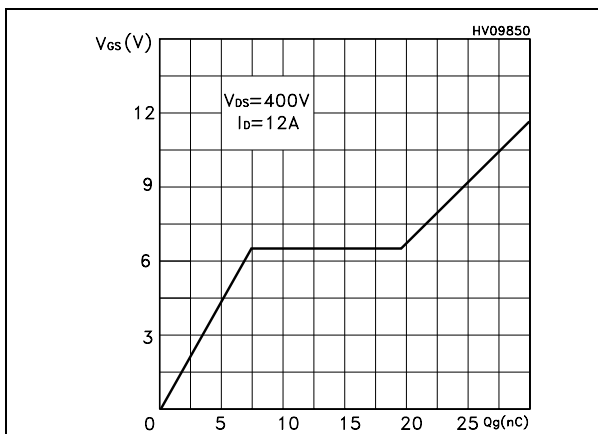

Figure 13. Normalized gate threshold voltage vs temperature

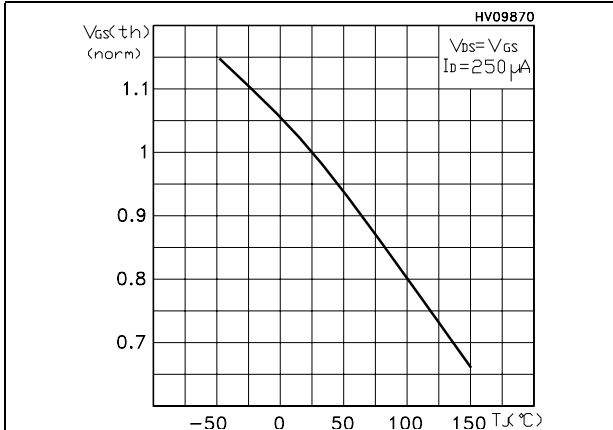

Figure 14. Normalized on resistance vs temperature

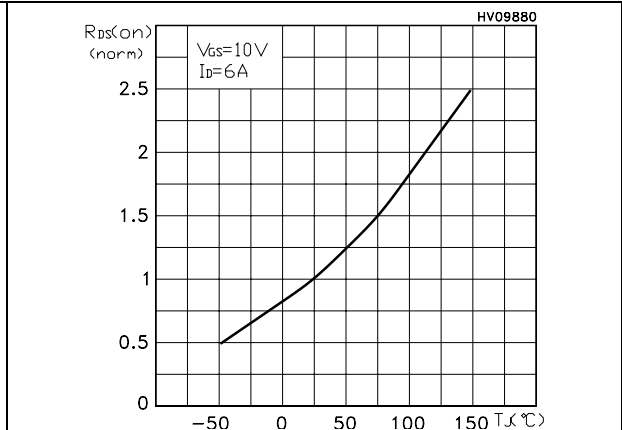

Figure 15. Source-drain diode forward characteristics

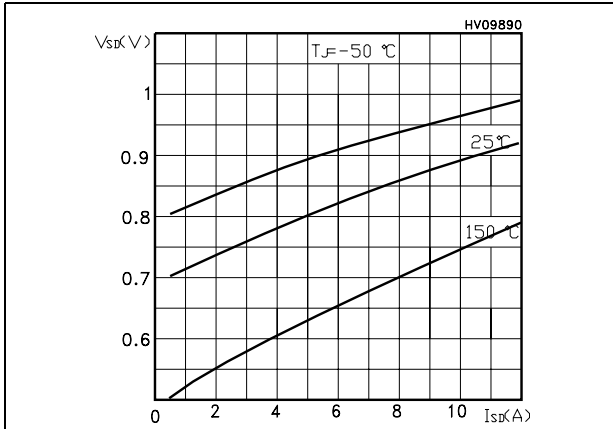
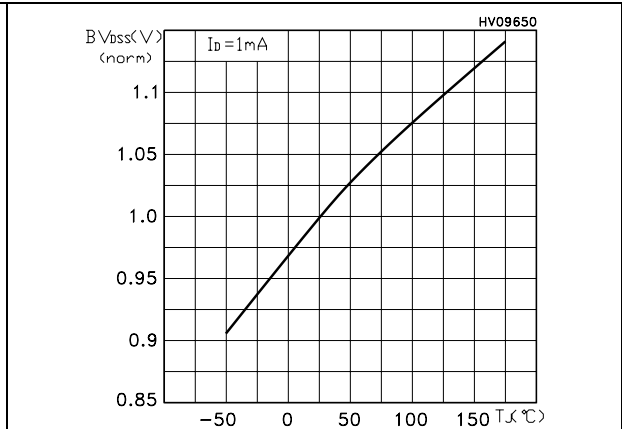

Figure 16. Normalized BV<sub>DSS</sub> vs temperature





### 3 Test circuit

Figure 17. Switching times test circuit for resistive load



Figure 18. Gate charge test circuit



Figure 19. Test circuit for inductive load switching and diode recovery times



Figure 20. Unclamped inductive load test circuit



Figure 21. Unclamped inductive waveform



Figure 22. Switching time waveform



## 4 Package mechanical data

In order to meet environmental requirements, ST offers these devices in ECOPACK® packages. These packages have a Lead-free second level interconnect . The category of second level interconnect is marked on the package and on the inner box label, in compliance with JEDEC Standard JESD97. The maximum ratings related to soldering conditions are also marked on the inner box label. ECOPACK is an ST trademark. ECOPACK specifications are available at : [www.st.com](http://www.st.com)

**TO-220 MECHANICAL DATA**

DIM.	mm.			inch		
	MIN.	TYP.	MAX.	MIN.	TYP.	MAX.
A	4.40		4.60	0.173		0.181
b	0.61		0.88	0.024		0.034
b1	1.15		1.70	0.045		0.066
c	0.49		0.70	0.019		0.027
D	15.25		15.75	0.60		0.620
E	10		10.40	0.393		0.409
e	2.40		2.70	0.094		0.106
e1	4.95		5.15	0.194		0.202
F	1.23		1.32	0.048		0.052
H1	6.20		6.60	0.244		0.256
J1	2.40		2.72	0.094		0.107
L	13		14	0.511		0.551
L1	3.50		3.93	0.137		0.154
L20		16.40			0.645	
L30		28.90			1.137	
øP	3.75		3.85	0.147		0.151
Q	2.65		2.95	0.104		0.116



**TO-247 MECHANICAL DATA**

DIM.	mm.			inch		
	MIN.	TYP	MAX.	MIN.	TYP.	MAX.
A	4.85		5.15	0.19		0.20
A1	2.20		2.60	0.086		0.102
b	1.0		1.40	0.039		0.055
b1	2.0		2.40	0.079		0.094
b2	3.0		3.40	0.118		0.134
c	0.40		0.80	0.015		0.03
D	19.85		20.15	0.781		0.793
E	15.45		15.75	0.608		0.620
e		5.45			0.214	
L	14.20		14.80	0.560		0.582
L1	3.70		4.30	0.14		0.17
L2		18.50			0.728	
øP	3.55		3.65	0.140		0.143
øR	4.50		5.50	0.177		0.216
S		5.50			0.216	

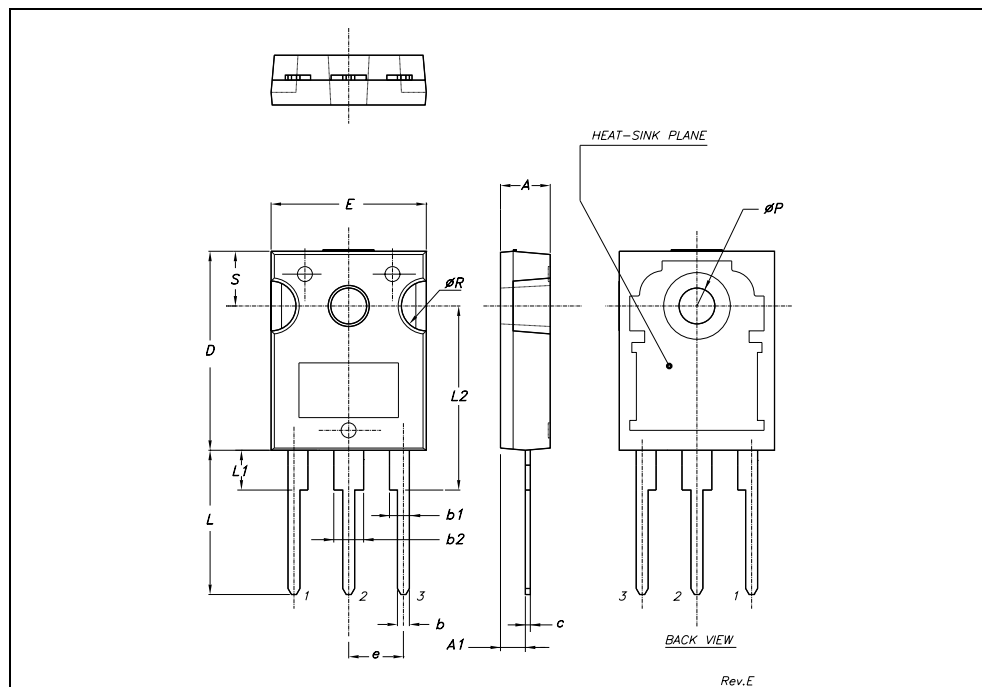

**D<sup>2</sup>PAK MECHANICAL DATA**

DIM.	mm.			inch		
	MIN.	TYP	MAX.	MIN.	TYP.	MAX.
A	4.4		4.6	0.173		0.181
A1	2.49		2.69	0.098		0.106
A2	0.03		0.23	0.001		0.009
B	0.7		0.93	0.027		0.036
B2	1.14		1.7	0.044		0.067
C	0.45		0.6	0.017		0.023
C2	1.23		1.36	0.048		0.053
D	8.95		9.35	0.352		0.368
D1		8			0.315	
E	10		10.4	0.393		
E1		8.5			0.334	
G	4.88		5.28	0.192		0.208
L	15		15.85	0.590		0.625
L2	1.27		1.4	0.050		0.055
L3	1.4		1.75	0.055		0.068
M	2.4		3.2	0.094		0.126
R		0.4			0.015	
V2	0°		4°			

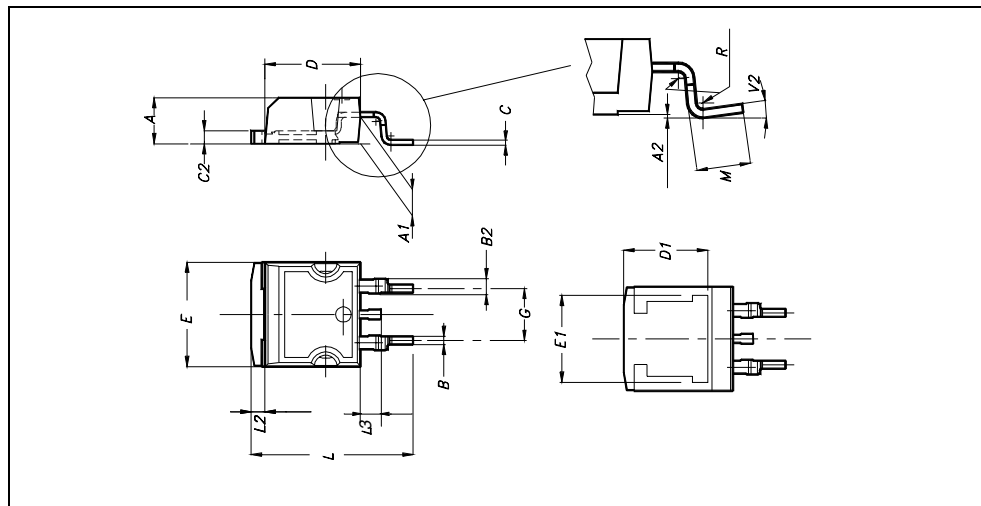

**TO-220FP MECHANICAL DATA**

DIM.	mm.			inch		
	MIN.	TYP	MAX.	MIN.	TYP.	MAX.
A	4.4		4.6	0.173		0.181
B	2.5		2.7	0.098		0.106
D	2.5		2.75	0.098		0.108
E	0.45		0.7	0.017		0.027
F	0.75		1	0.030		0.039
F1	1.15		1.7	0.045		0.067
F2	1.15		1.7	0.045		0.067
G	4.95		5.2	0.195		0.204
G1	2.4		2.7	0.094		0.106
H	10		10.4	0.393		0.409
L2		16			0.630	
L3	28.6		30.6	1.126		1.204
L4	9.8		10.6	.0385		0.417
L5	2.9		3.6	0.114		0.141
L6	15.9		16.4	0.626		0.645
L7	9		9.3	0.354		0.366
Ø	3		3.2	0.118		0.126

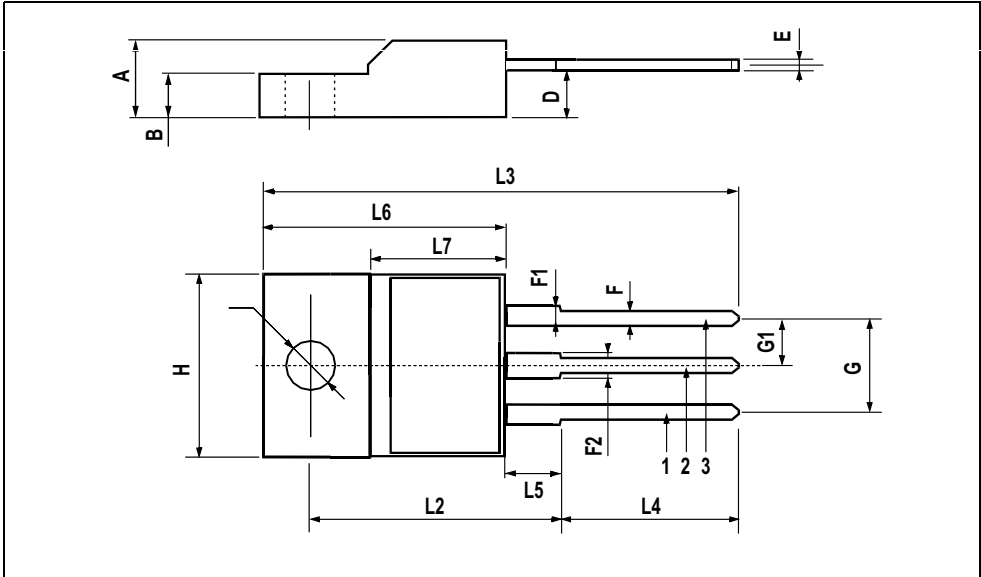

TO-262 (I<sup>2</sup>PAK) MECHANICAL DATA

DIM.	mm.			inch		
	MIN.	TYP.	MAX.	MIN.	TYP.	MAX.
A	4.40		4.60	0.173		0.181
A1	2.40		2.72	0.094		0.107
b	0.61		0.88	0.024		0.034
b1	1.14		1.70	0.044		0.066
c	0.49		0.70	0.019		0.027
c2	1.23		1.32	0.048		0.052
D	8.95		9.35	0.352		0.368
e	2.40		2.70	0.094		0.106
e1	4.95		5.15	0.194		0.202
E	10		10.40	0.393		0.410
L	13		14	0.511		0.551
L1	3.50		3.93	0.137		0.154
L2	1.27		1.40	0.050		0.055

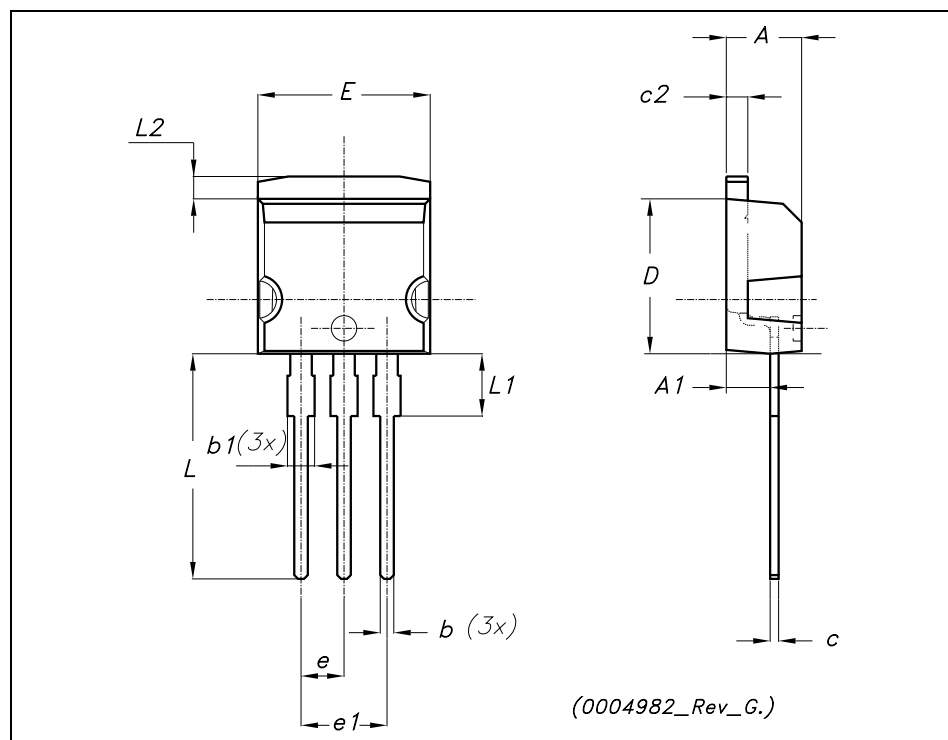

# 5 Packaging mechanical data

## D<sup>2</sup>PAK FOOTPRINT



## TAPE AND REEL SHIPMENT

**TAPE MECHANICAL DATA**

DIM.	mm		inch	
	MIN.	MAX.	MIN.	MAX.
A0	10.5	10.7	0.413	0.421
B0	15.7	15.9	0.618	0.626
D	1.5	1.6	0.059	0.063
D1	1.59	1.61	0.062	0.063
E	1.65	1.85	0.065	0.073
F	11.4	11.6	0.449	0.456
K0	4.8	5.0	0.189	0.197
P0	3.9	4.1	0.153	0.161
P1	11.9	12.1	0.468	0.476
P2	1.9	2.1	0.075	0.082
R	50		1.574	
T	0.25	0.35	0.0098	0.0137
W	23.7	24.3	0.933	0.956

**REEL MECHANICAL DATA**

DIM.	mm		inch	
	MIN.	MAX.	MIN.	MAX.
A		330		12.992
B	1.5		0.059	
C	12.8	13.2	0.504	0.520
D	20.2		0.795	
G	24.4	26.4	0.960	1.039
N	100		3.937	
T		30.4		1.197

BASE QTY	BULK QTY
1000	1000

\* on sales type



## 6 Revision history

**Table 8. Revision history**

Date	Revision	Changes
03-May-2006	3	New template

**Please Read Carefully:**

Information in this document is provided solely in connection with ST products. STMicroelectronics NV and its subsidiaries ("ST") reserve the right to make changes, corrections, modifications or improvements, to this document, and the products and services described herein at any time, without notice.

All ST products are sold pursuant to ST's terms and conditions of sale.

Purchasers are solely responsible for the choice, selection and use of the ST products and services described herein, and ST assumes no liability whatsoever relating to the choice, selection or use of the ST products and services described herein.

No license, express or implied, by estoppel or otherwise, to any intellectual property rights is granted under this document. If any part of this document refers to any third party products or services it shall not be deemed a license grant by ST for the use of such third party products or services, or any intellectual property contained therein or considered as a warranty covering the use in any manner whatsoever of such third party products or services or any intellectual property contained therein.

**UNLESS OTHERWISE SET FORTH IN ST'S TERMS AND CONDITIONS OF SALE ST DISCLAIMS ANY EXPRESS OR IMPLIED WARRANTY WITH RESPECT TO THE USE AND/OR SALE OF ST PRODUCTS INCLUDING WITHOUT LIMITATION IMPLIED WARRANTIES OF MERCHANTABILITY, FITNESS FOR A PARTICULAR PURPOSE (AND THEIR EQUIVALENTS UNDER THE LAWS OF ANY JURISDICTION), OR INFRINGEMENT OF ANY PATENT, COPYRIGHT OR OTHER INTELLECTUAL PROPERTY RIGHT.**

**UNLESS EXPRESSLY APPROVED IN WRITING BY AN AUTHORIZED REPRESENTATIVE OF ST, ST PRODUCTS ARE NOT DESIGNED, AUTHORIZED OR WARRANTED FOR USE IN MILITARY, AIR CRAFT, SPACE, LIFE SAVING, OR LIFE SUSTAINING APPLICATIONS, NOR IN PRODUCTS OR SYSTEMS, WHERE FAILURE OR MALFUNCTION MAY RESULT IN PERSONAL INJURY, DEATH, OR SEVERE PROPERTY OR ENVIRONMENTAL DAMAGE.**

Resale of ST products with provisions different from the statements and/or technical features set forth in this document shall immediately void any warranty granted by ST for the ST product or service described herein and shall not create or extend in any manner whatsoever, any liability of ST.

ST and the ST logo are trademarks or registered trademarks of ST in various countries.

Information in this document supersedes and replaces all information previously supplied.

The ST logo is a registered trademark of STMicroelectronics. All other names are the property of their respective owners.

© 2006 STMicroelectronics - All rights reserved

STMicroelectronics group of companies

Australia - Belgium - Brazil - Canada - China - Czech Republic - Finland - France - Germany - Hong Kong - India - Israel - Italy - Japan - Malaysia - Malta - Morocco - Singapore - Spain - Sweden - Switzerland - United Kingdom - United States of America

[www.st.com](http://www.st.com)