

# SEMiX 653GB176HD ...

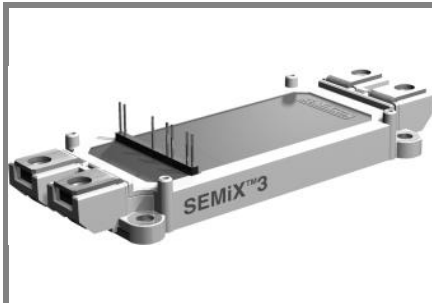

**SEMiX® 3**

## Trench IGBT Modules

**SEMiX 653GB176HD**

**SEMiX 653GAL176HD**

**SEMiX 653GAR176HD**

Preliminary Data

### Features

- Homogeneous Si
- Trench = Trenchgate technology
- $V_{CE(sat)}$  with positive temperature coefficient
- High short circuit capability

### Typical Applications

- AC inverter drives
- UPS
- Electronic welders

### Remarks

- short circuit capability is tested @  $V_{CC}=1000V$  (all other static parameters are tested @  $V_{CC}=1200V$ )

Absolute Maximum Ratings		$T_c = 25\text{ °C}$ , unless otherwise specified	
Symbol	Conditions	Values	Units
<b>IGBT</b>			
$V_{CES}$		1700	V
$I_C$	$T_c = 25\text{ (80) °C}$	650 (460)	A
$I_{CRM}$	$t_p = 1\text{ ms}$	900	A
$V_{GES}$		$\pm 20$	V
$T_{vj}$ ( $T_{stg}$ )	$T_{OPERATION} \leq T_{stg}$	- 40 ... + 150 (125)	°C
$V_{isol}$	AC, 1 min.	4000	V
<b>Inverse diode</b>			
$I_F$	$T_c = 25\text{ (80) °C}$	500 (340)	A
$I_{FRM}$	$t_p = 1\text{ ms}$	900	A
$I_{FSM}$	$t_p = 10\text{ ms; sin.; } T_j = 150\text{ °C}$	2900	A

Characteristics		$T_c = 25\text{ °C}$ , unless otherwise specified			
Symbol	Conditions	min.	typ.	max.	Units
<b>IGBT</b>					
$V_{GE(th)}$	$V_{GE} = V_{CE}, I_C = 18\text{ mA}$	5,2	5,8	6,4	V
$I_{CES}$	$V_{GE} = 0, V_{CE} = V_{CES}, T_j = 25\text{ ( ) °C}$			0,45	mA
$V_{CE(TO)}$	$T_j = 25\text{ (125) °C}$		1 (0,9)	1,2 (1,1)	V
$r_{CE}$	$V_{GE} = 0\text{ V}, T_j = 25\text{ (125) °C}$		2,2 (3,4)	2,8 (4)	mΩ
$V_{CE(sat)}$	$I_{Cnom} = 450\text{ A}, V_{GE} = 15\text{ V}, T_j = 25\text{ (125) °C, chip level}$		2 (2,45)	2,45 (2,9)	V
$C_{ies}$	under following conditions		40		nF
$C_{oes}$	$V_{GE} = 0, V_{CE} = 25\text{ V}, f = 1\text{ MHz}$		1,7		nF
$C_{res}$			1,3		nF
$L_{CE}$			20		nH
$R_{CC'+EE'}$	terminal-chip, $T_c = 25\text{ (125) °C}$		0,7 (1)		mΩ
$t_{d(on)}/t_r$	$V_{CC} = 1200\text{ V}, I_{Cnom} = 450\text{ A}$		290 / 90		ns
$t_{d(off)}/t_f$	$V_{GE} = \pm 15\text{ V}$		975 / 190		ns
$E_{on} (E_{off})$	$R_{Gon} = R_{Goff} = 3,6\text{ Ω}, T_j = 125\text{ °C}$		300 (180)		mJ
<b>Inverse diode</b>					
$V_F = V_{EC}$	$I_{Fnom} = 450\text{ A}; V_{GE} = 0\text{ V}; T_j = 25\text{ (125) °C, chip level}$		1,7 (1,8)	2 (2,1)	V
$V_{(TO)}$	$T_j = 25\text{ (125) °C}$		1,1 (0,9)	1,3 (1,1)	V
$r_T$	$T_j = 25\text{ (125) °C}$		1,3 (2)	1,6 (2,2)	mΩ
$I_{RRM}$	$I_{Fnom} = 450\text{ A}; T_j = 25\text{ (125) °C}$		(380)		A
$Q_{rr}$	$di/dt = 4200\text{ A/μs}$		(130)		μC
$E_{rr}$	$V_{GE} = -15\text{ V}$		(73)		mJ
<b>Thermal characteristics</b>					
$R_{th(j-c)}$	per IGBT			0,05	K/W
$R_{th(j-c)D}$	per Inverse Diode			0,11	K/W
$R_{th(j-c)FD}$	per FWD				K/W
$R_{th(c-s)}$	per module		0,04		K/W
<b>Temperature sensor</b>					
$R_{25}$	$T_c = 25\text{ °C}$		5 ±5%		kΩ
$B_{25/85}$	$R_2 = R_1 \exp[B(1/T_2 - 1/T_1)]; T[K]; B$		3420		K
<b>Mechanical data</b>					
$M_s/M_t$	to heatsink (M5) / for terminals (M6)	3/2,5		5 / 5	Nm
w			289		g

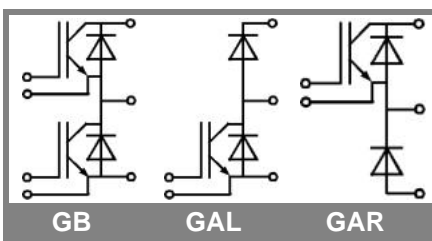

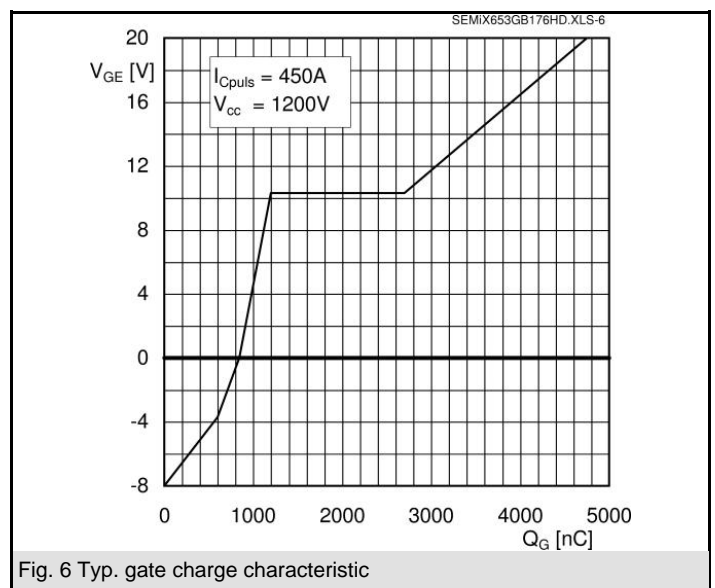
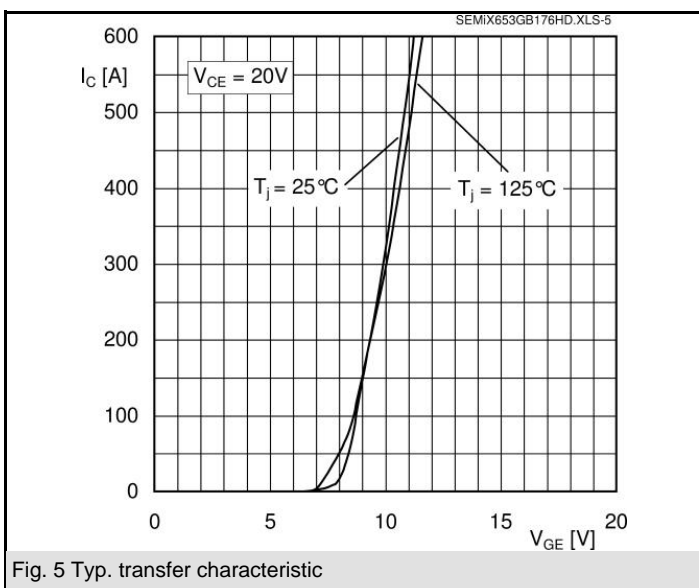
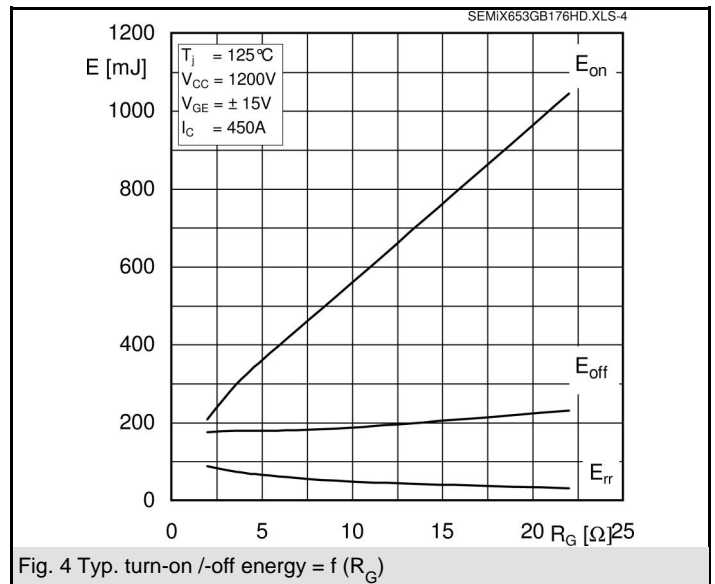
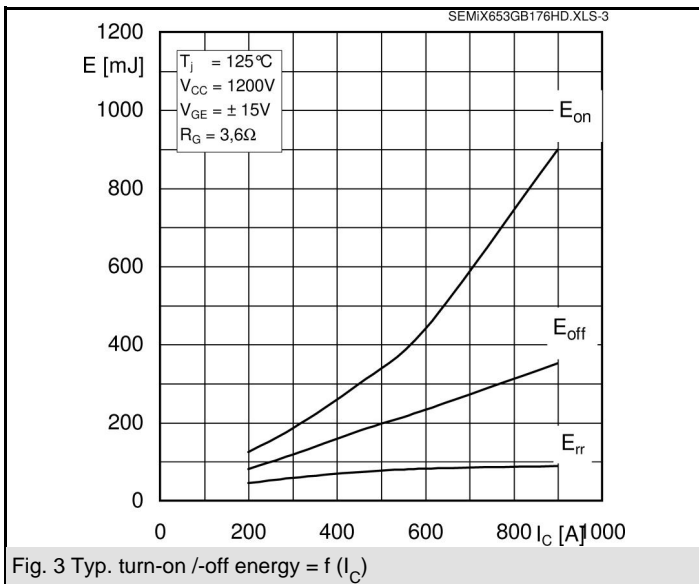
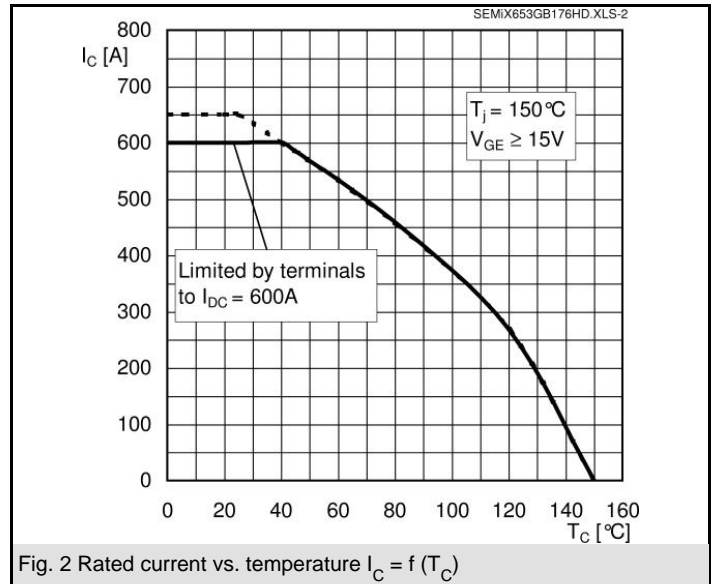
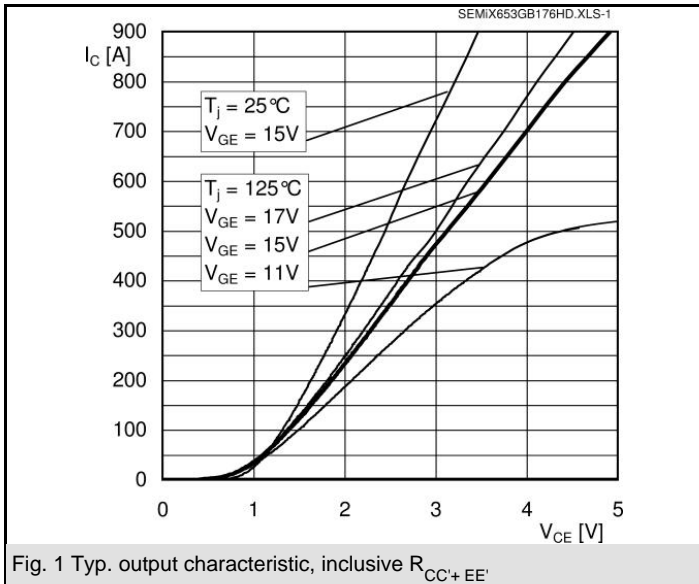

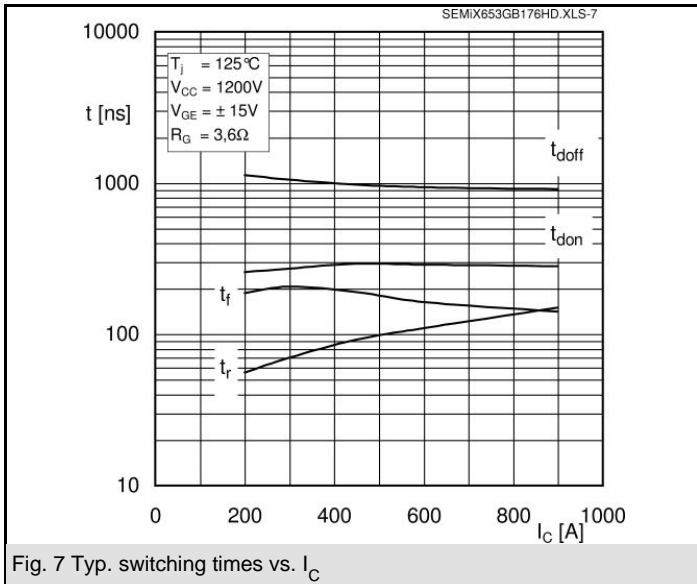

Fig. 7 Typ. switching times vs.  $I_C$

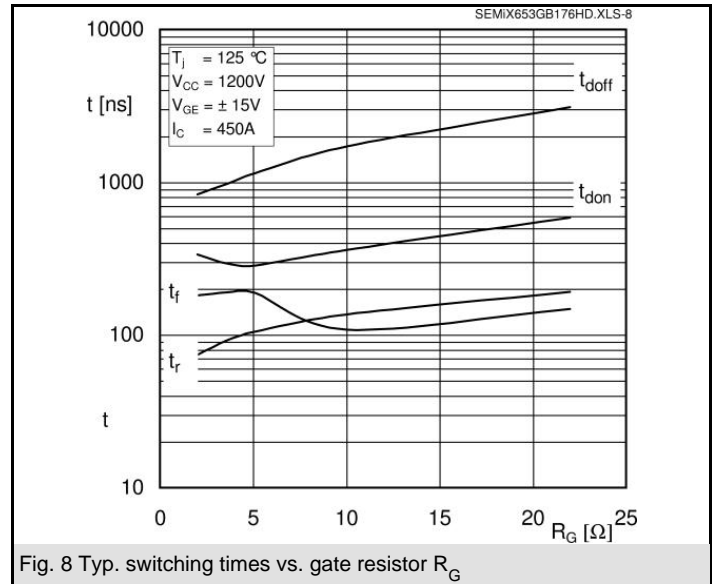

Fig. 8 Typ. switching times vs. gate resistor  $R_G$

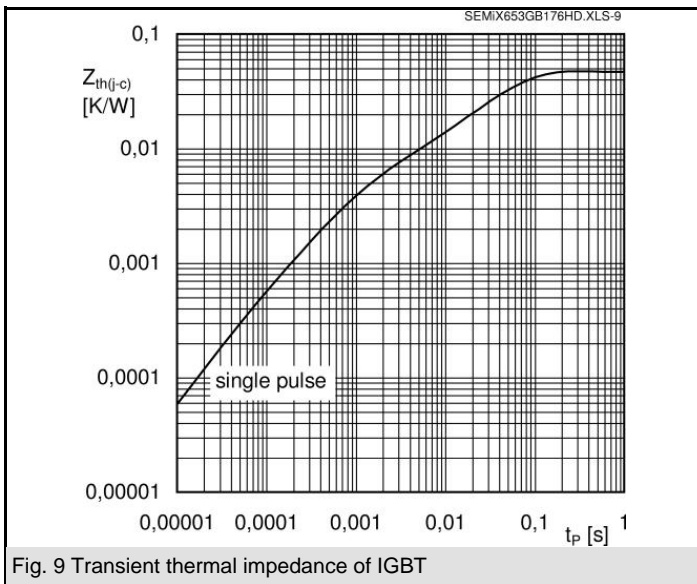

Fig. 9 Transient thermal impedance of IGBT

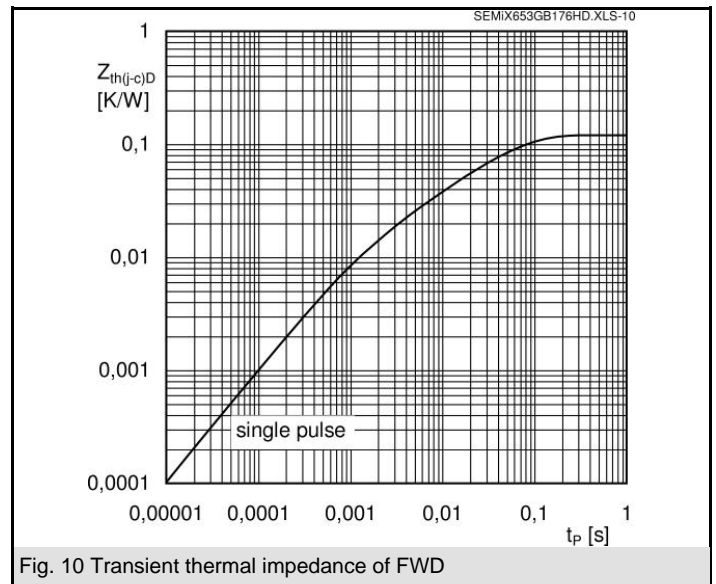

Fig. 10 Transient thermal impedance of FWD

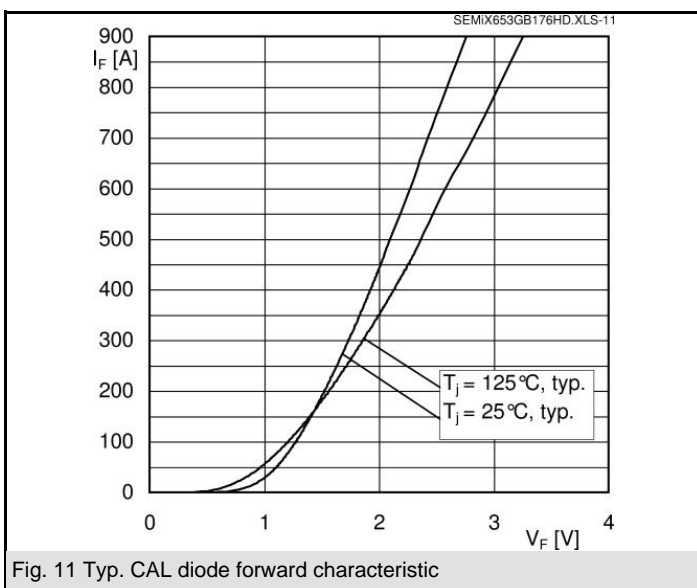

Fig. 11 Typ. CAL diode forward characteristic

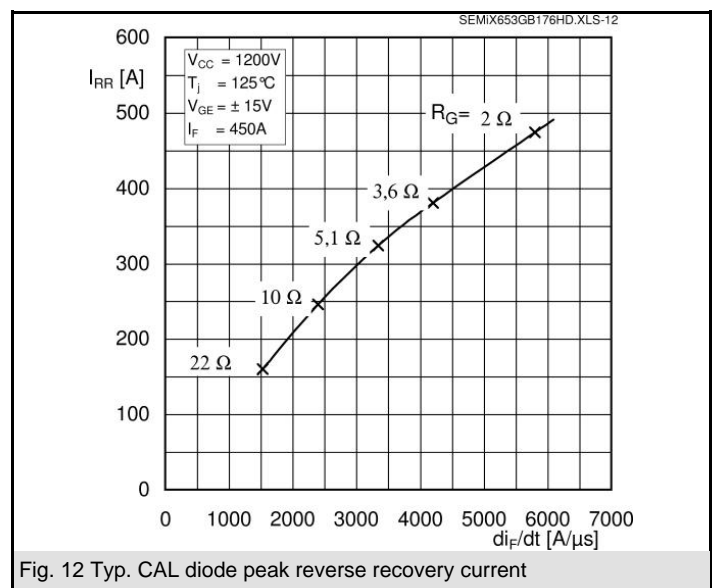
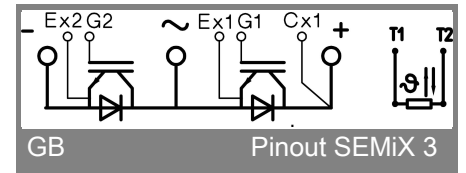
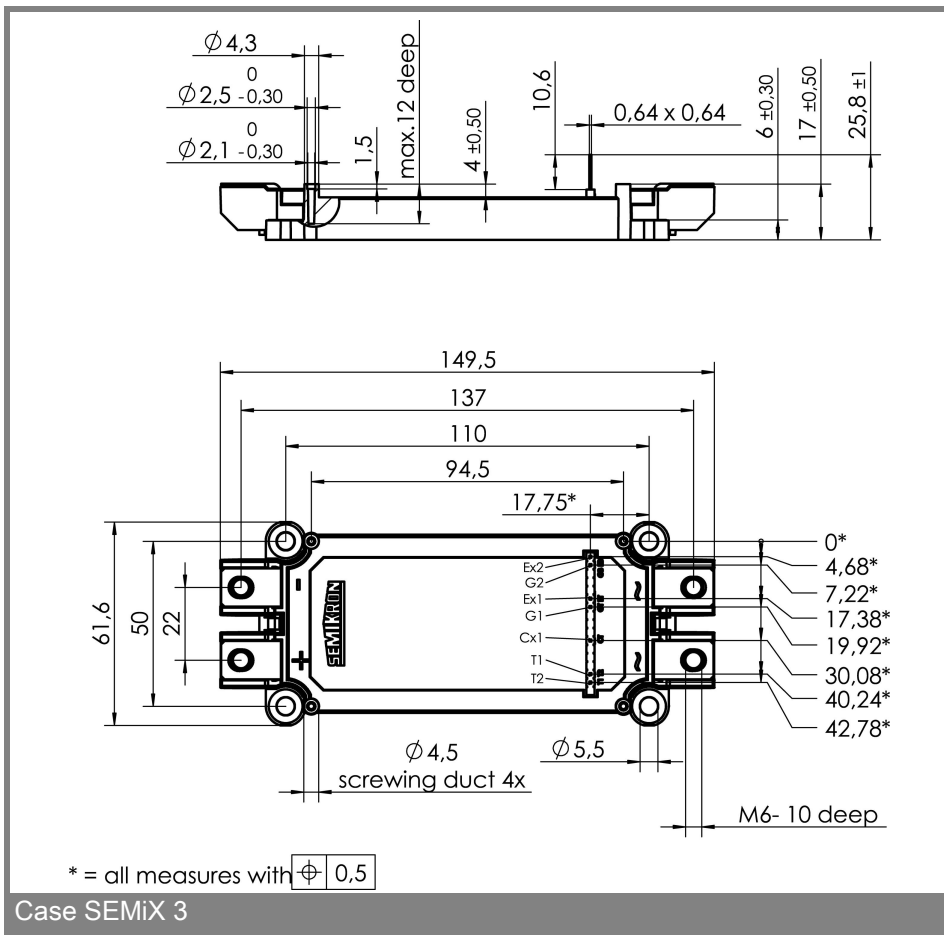
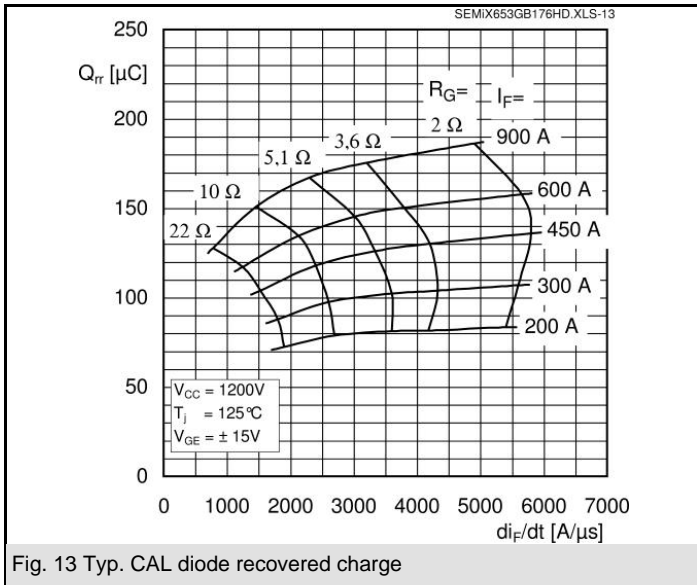

Fig. 12 Typ. CAL diode peak reverse recovery current

# SEMiX 653GB176HD ...



This is an electrostatic discharge sensitive device (ESDS), international standard IEC 60747-1, Chapter IX.

This technical information specifies semiconductor devices but promises no characteristics. No warranty or guarantee expressed or implied is made regarding delivery, performance or suitability.