

Specifications are subject to change without notice.

DESCRIPTION

MGFS36E2527 is GaAs RF amplifier designed for WiMAX CPE.

FEATURES

- InGaP HBT Device
- 6V Operation
- 27dBm Linear Output Power
- 33dB Linear Gain
- Integrated Output Power Detector
- Integrated 1-bit 19dB Step Attenuator
- 50ohms Matched
- Surface Mount Package
- RoHS Compliant Package

APPLICATION

IEEE802.16-2004, IEEE802.16e-2005

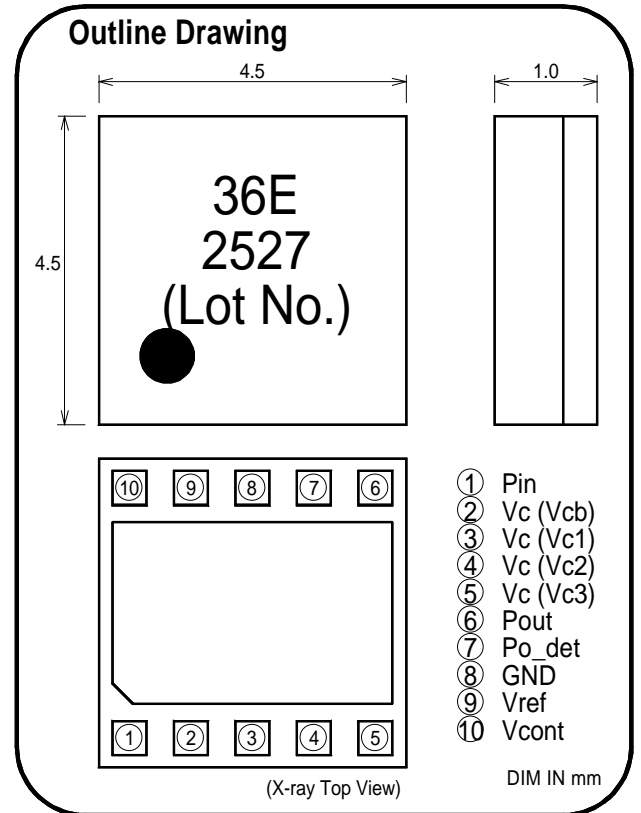

FUNCTIONAL BLOCK DIAGRAM

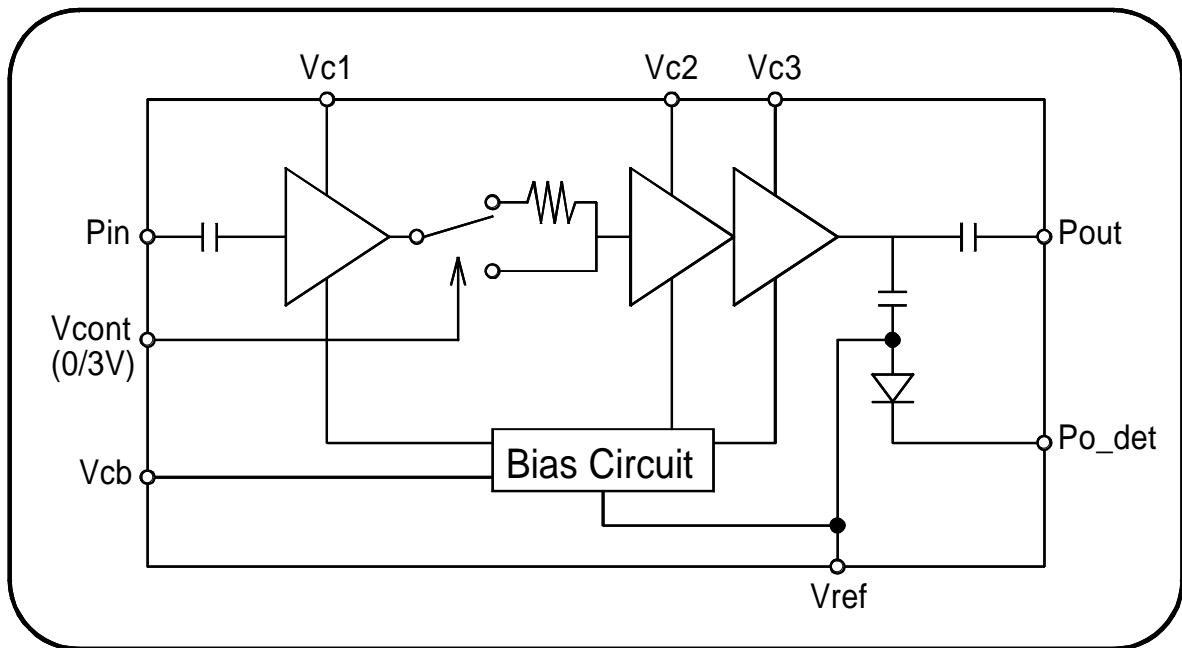

Mitsubishi Electric Corporation puts the maximum effort into making semiconductor products better and more reliable, but there is always the possibility that trouble may occur with them. Trouble with semiconductors may lead to personal injury, fire or property damage. Remember to give due consideration to safety when making your circuit designs, with appropriate measures such as (i)placement of substitutive, auxiliary, circuits, (ii)use of non-flammable material or (iii)prevention against any malfunction or mishap.

Specifications are subject to change without notice.

ABSOLUTE MAXIMUM RATINGS (Ta=25°C)

Symbol	Parameter	Conditions*	Value	Unit
Vc1, Vc2 Vc3, Vcb	Collector Supply Voltage	Pout≤27.0dBm	8	V
Vref	Reference Voltage	Pout≤27.0dBm	3	V
Vcont	ATT Control Voltage	Pout≤27.0dBm	3.3	V
Ic1	Operation Current	Pout≤27.0dBm	80	mA
Ic2			250	mA
Ic3			900	mA
Pin	Input Power	Pout≤27.0dBm	5	dBm
-	Duty Cycle	Pout≤27.0dBm	50	%
Tc(op)	Operation Temperature	Pout≤27.0dBm	-30~+85	°C
Tstg	Storage Temperature	-	-40~+125	°C

*NOTE : Zin=Zout=50Ω

Each maximum rating is guaranteed independently.

Please take care that MGFS36E2527 is operated under these conditions at the worst case on your terminal.

ELECTRICAL CHARACTERISTICS (Ta=25°C)

Symbol	Parameter	Test Conditions*	Limits			Unit
			Min	Typ	Max	
f	Frequency	-	2.5		2.7	GHz
Gp	Gain	Vc=6V, Vref=2.85V		33		dB
ηt	Efficiency	Pout=27dBm		12		%
EVM	EVM	64QAM OFDM Modulation		2.5		%
Vdet	Power Detector Voltage	Duty Cycle < 50%		2.0		V
ATT	Control Gain Step	Vcont=3V		19		dB
Ileak	Leakage Current	Vc=6V, Vref=0V			10	μA

*NOTE : Zin=Zout=50Ω

ESD RATING - Class 1A (HBM)

MOISTURE SENSITIVITY LEVEL - Level 3

Specifications are subject to change without notice.

PERFORMANCE DATA

WiMAX OFDM 64QAM signal input. Ta=25degC.

Output Power vs. Input Power

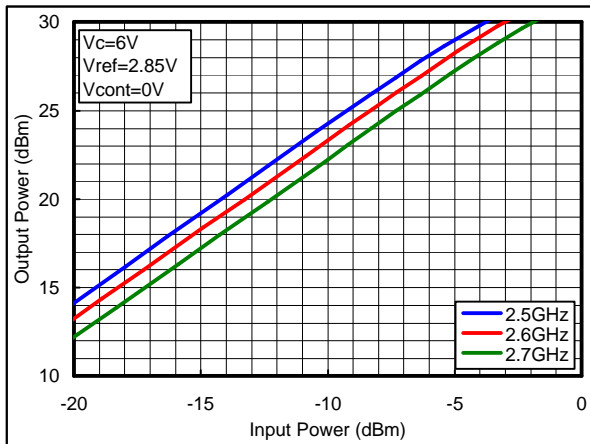

Efficiency vs. Output Power

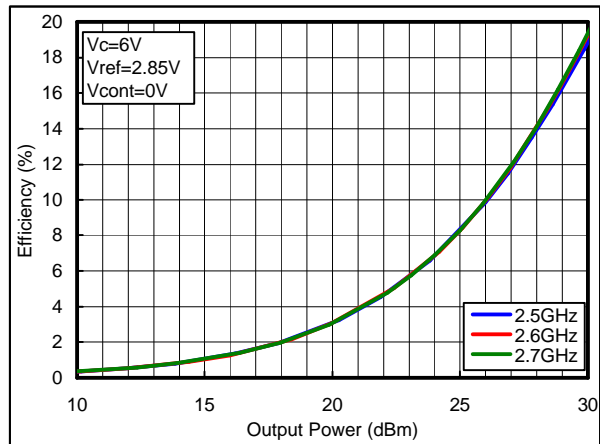

EVM vs. Output Power

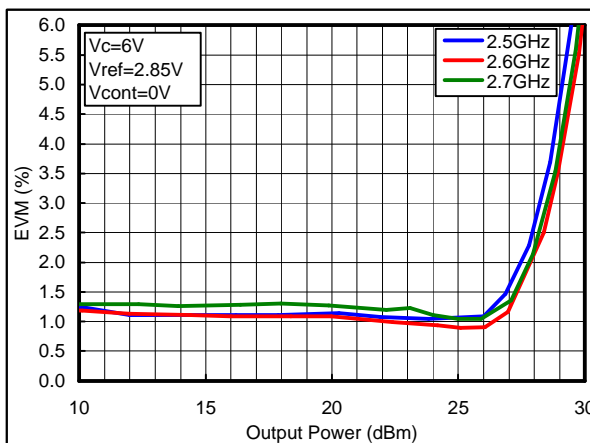

Detector Voltage vs. Output Power

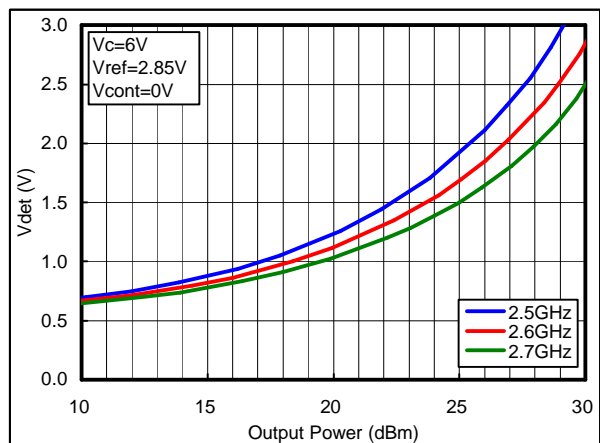

Attenuation Performance

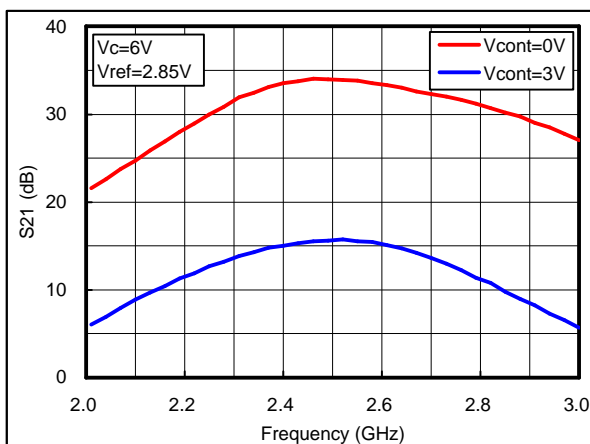

Specifications are subject to change without notice.

WiMAX OFDM 64QAM signal input.

Output Power vs. Input Power

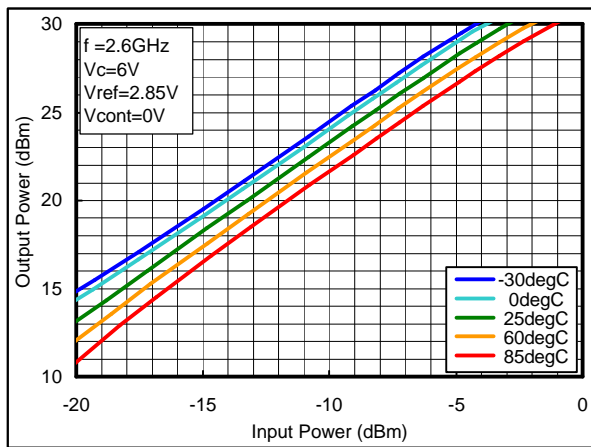

Efficiency vs. Output Power

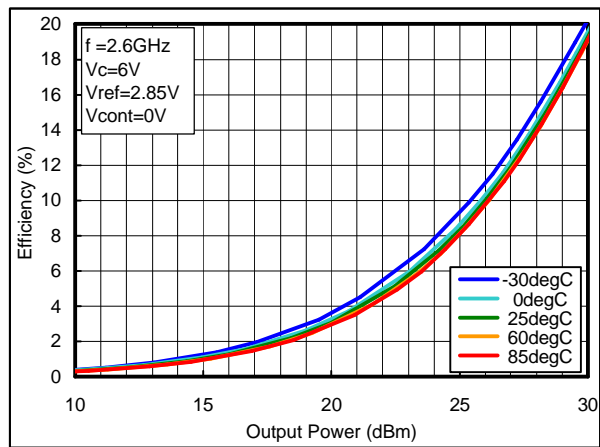

EVM vs. Output Power

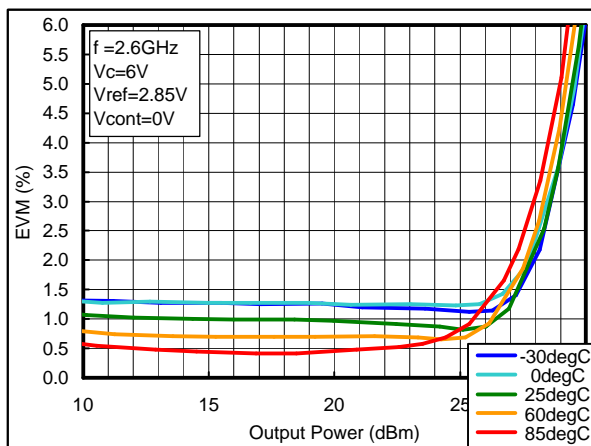

Detector Voltage vs. Output Power

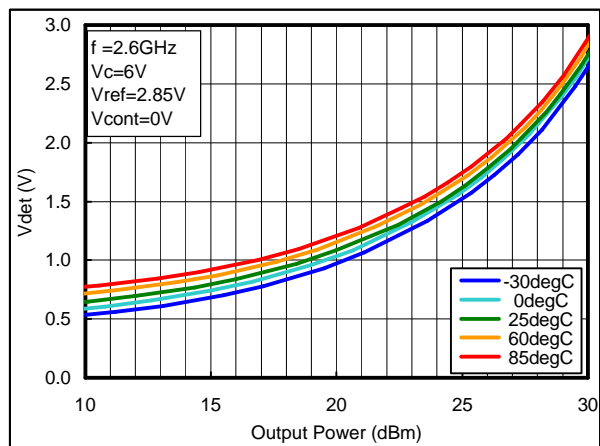

Attenuation Level

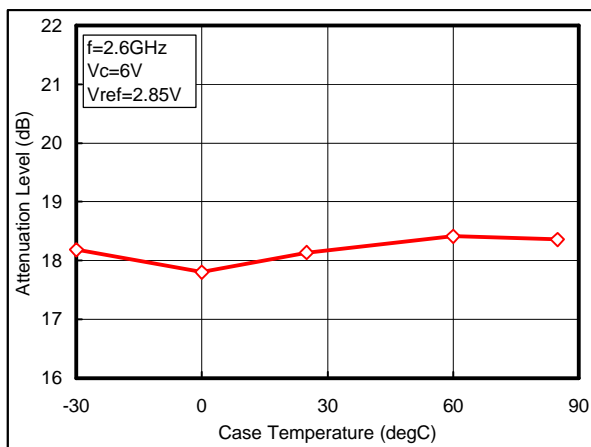

Specifications are subject to change without notice.

WiMAX OFDM 64QAM signal input. Ta=25degC.

Output Power vs. Input Power

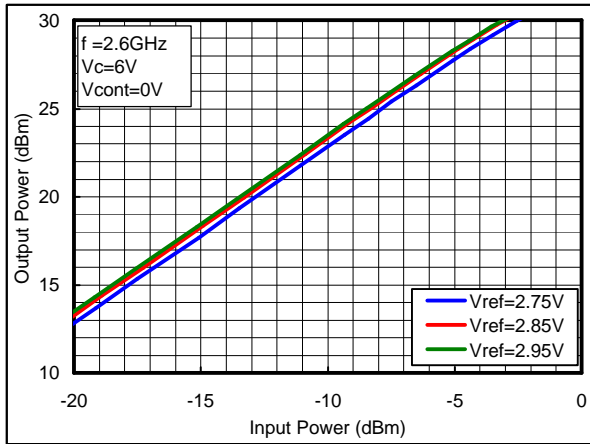

Efficiency vs. Output Power

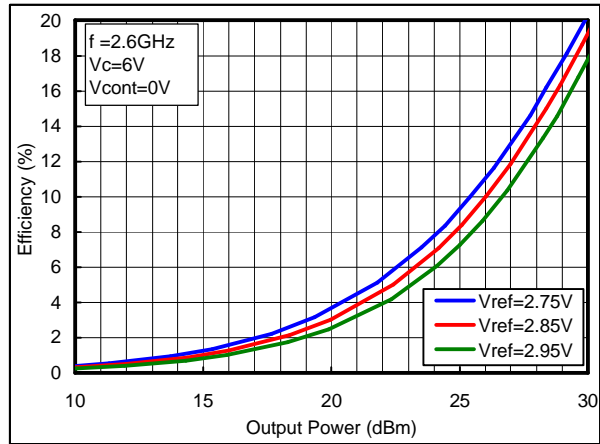

EVM vs. Output Power

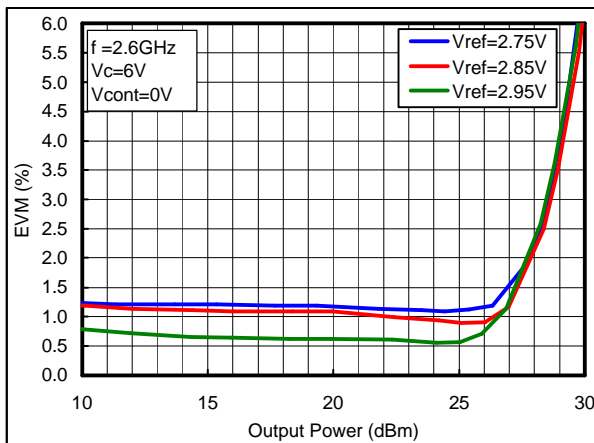

Detector Voltage vs. Output Power

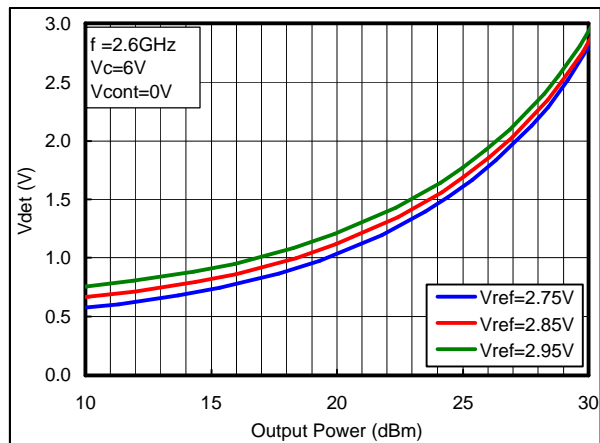

Attenuation Level

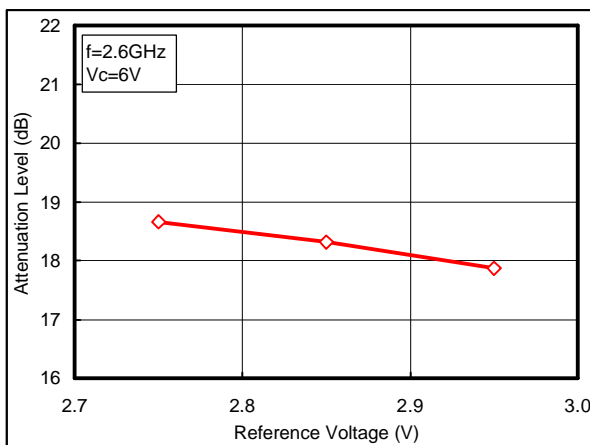

Specifications are subject to change without notice.

APPLICATION CIRCUIT

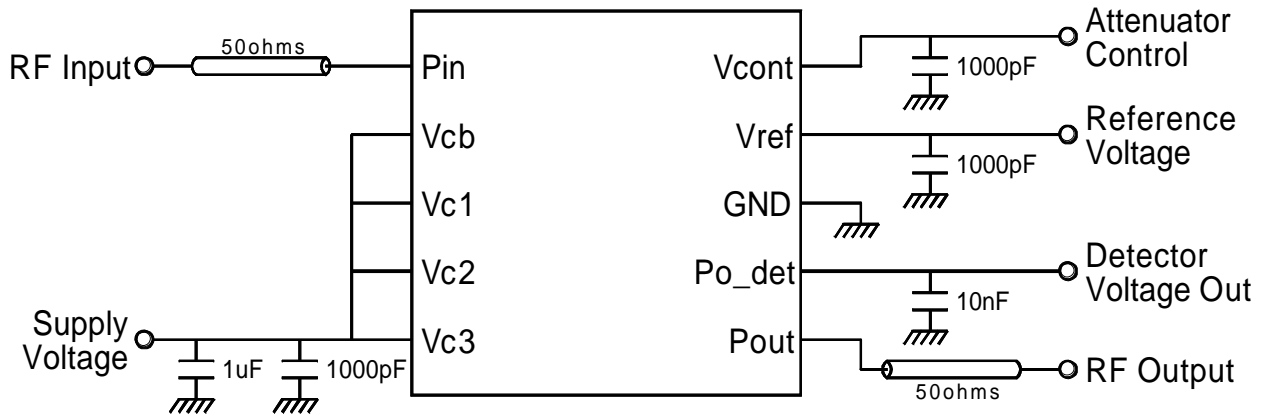

Pulse Operation is controlled by Vref

PACKAGE OUTLINE

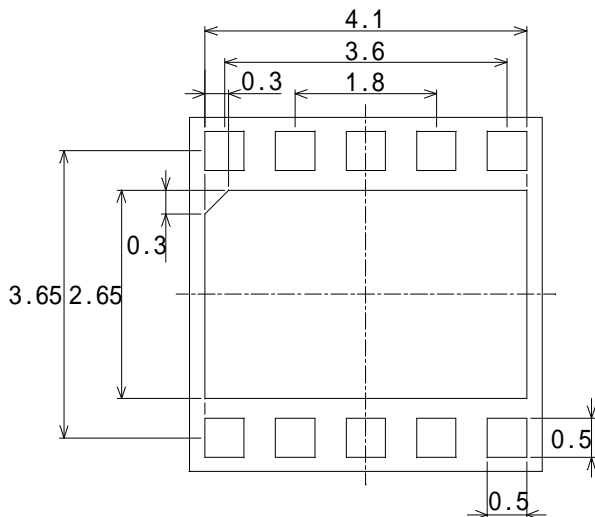
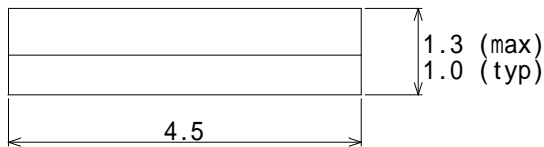
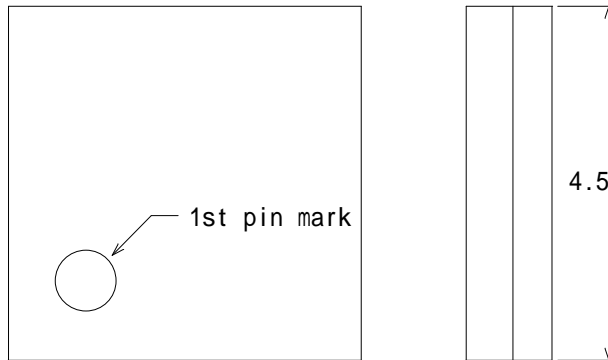

Dimension in millimeters.
Unless specified tolerance $\pm 0.2\text{mm}$.

Specifications are subject to change without notice.

HANDLING PRECAUTION

- 1) Work desk, test equipment, soldering iron and worker should be grounded before mounting and testing. Please note that electric discharge of GaAs HBT is much more sensitive than that of Si transistor. Handling without ground possibly damages GaAs HBT.
- 2) The surface of a board on which this product is mounted should be as flat and clean as possible to prevent a substrate from cracking by bending this product.
- 3) IR reflow soldering condition is confirmed following profile.

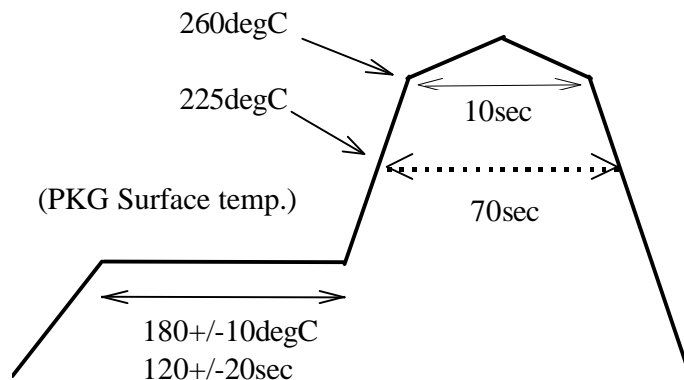

- 4) Handling precaution at high temperature
This product has the structure of sealing with epoxy resin on glass epoxy substrate. This epoxy resin gets soft if the temperature exceeds glass transition temperature=120degC, and the thermic decomposition is occurred if the temperature exceeds 350degC. Therefore, in case of heating this product, please keep the same heat profile as recommended reflow one.
Please note that crack, flaw or modification may be generated if softened epoxy resin part is handled with tweezers and etc at high temperature.
- 5) Cleaning condition
Please select after confirming administrative guidance, legal restrictions, and the mass of the residual ion contaminant etc., and use it.
- 6) After soldering, please remove the flux. Please take care that solvent does not penetrate into this product.
- 7) GaAs HBT contains As(Arsenic). This product should be dumped as particular industrial waste.