



Resistance Weld Thru-Hole Crystal

Model: HC49ULF

RoHS Compliant / Pb Free

Rev. 2/27/2006

Page 1 of 2

http://www.foxonline.com/need_a_sample.htm

Need a
Sample®

FEATURES

- Low Cost
- Stocking Standard (see page 2)
- High Frequency Range
- Fundamental to 40 MHz
- Resistance Weld

OPTIONS

- Tolerances to 5 PPM
- Stabilities to 3 PPM
- Temperatures to -40°C ~ +105°C
- Mylar Spacer
- Vinyl Sleeve
- Third Lead

• PART NUMBER [Learn More](#) - Internet Required

Part Number	Model Number	Frequency Range (MHz)
281LF-Frequency-xxxxx	HC49ULF	1.8432 ~ 180.000

• STANDARD SPECIFICATIONS¹

PARAMETERS	MAX (unless otherwise noted)
Frequency Range	1.8432 ~ 180.000 MHz
Frequency Tolerance @ 25°C	±30 PPM
Frequency Stability, ref @ 25°C Over Operating Temp Range	±50 PPM
Temperature Range	
Operating (TOPR)	-20°C ~ +70°C
Storage (TSTG)	-40°C ~ +85°C
Shunt Capacitance (Co)	7.0 pF
Load Capacitance (CL)	10 pF ~ Series (Customer Specified)
Drive Level	
1.8432 ~ 3.000 MHz	2.0 mW
3.000+ ~ 180.000 MHz	1.0 mW
Aging per year	±5 PPM

¹ Other tolerances, stabilities & operating temperature ranges available. Consult Fox Customer Service for specific requirements.

All specifications subject to change without notice.

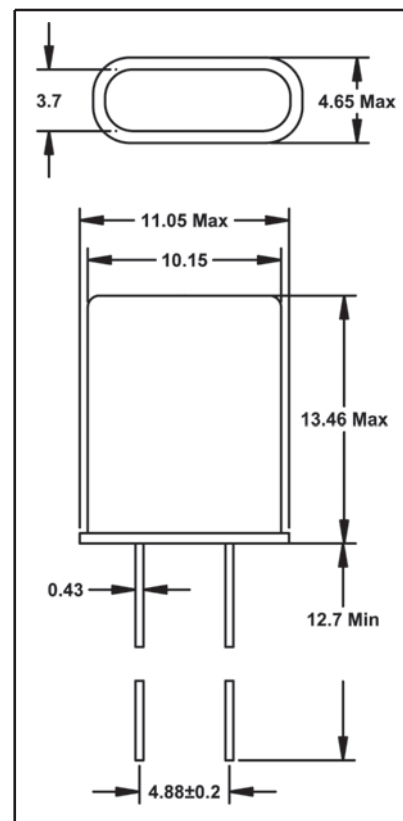

All dimensions are in millimeters.

TERMINATION FINISH: Sn/3.0Ag/0.5Cu

Frequency Range (MHz)	Operating Mode	Max ESR Ω
1.8432 ~ 2.000	Fundamental	750
2.000+ ~ 2.400	Fundamental	500
2.400+ ~ 3.000	Fundamental	300
3.000+ ~ 3.200	Fundamental	200
3.200+ ~ 3.700	Fundamental	120
3.700+ ~ 4.200	Fundamental	100
4.200+ ~ 4.900	Fundamental	70
4.900+ ~ 5.000	Fundamental	55
5.000+ ~ 6.000	Fundamental	50
6.000+ ~ 8.000	Fundamental	40
8.000+ ~ 10.000	Fundamental	35
10.000+ ~ 12.500	Fundamental	30
12.500+ ~ 16.000	Fundamental	25
16.000+ ~ 40.000	Fundamental	20
23.000+ ~ 75.000	3rd OT	40
60.000 ~ 110.000	5th OT	80
110.000 ~ 180.000	7th OT	120

HC49ULF Marking Identification

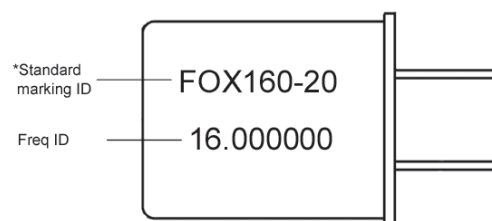

* Non-standard marking: 1st line "FOX" only.

pm_HC49U.gif_Rev01

Resistance Weld Thru-Hole Crystal



Model: HC49ULF

RoHS Compliant / Pb Free

Rev. 2/27/2006

Page 2 of 2

http://www.foxonline.com/need_a_sample.htm



• FOX STANDARD SPECIFICATIONS	
PARAMETER	HC49ULF
Frequency Tolerance @ 25°C	±30PPM
Frequency Stability	±50PPM
Operating Temperature Range	-20°C ~ +70°C

All specifications subject to change without notice.

• HC49ULF Standard Crystals

Frequency	CL	HC49ULF Part Number	ESR Ω Max
1.843200	13pF	FOXLF018S	800
2.457600	32pF	FOXLF024S	300
3.579545	18pF	FOXLF036S	120
3.686400	Series	FOXLF038S	120
3.686400	20pF	FOXLF0368-20	120
4.000000	Series	FOXLF040A	100
4.000000	20pF	FOXLF040	100
8.000000	20pF	FOXLF080-20	35
10.000000	20pF	FOXLF100-20	30
11.059200	Series	FOXLF115	30
11.059200	20pF	FOXLF115-20	30
12.000000	Series	FOXLF120	30
12.000000	20pF	FOXLF120-20	30
16.000000	Series	FOXLF160	25
16.000000	20pF	FOXLF160-20	25
20.000000	20pF	FOXLF200-20	20
25.000000	20pF	FOXLF250F-20 (Fundamental)	20