

$V_{SM} = 2800 \text{ V}$

$I_{TAVM} = 2630 \text{ A}$

$I_{TRMS} = 4130 \text{ A}$

$I_{TSM} = 43000 \text{ A}$

$V_{T0} = 0.85 \text{ V}$

$r_T = 0.160 \text{ m}\Omega$

## Bi-Directional Control Thyristor

# 5STB 24Q2800

Doc. No. 5SYA1053-01 Sep. 01

- Two thyristors integrated into one wafer
- Patented free-floating silicon technology
- Designed for traction, energy and industrial applications
- Optimum power handling capability
- Interdigitated amplifying gate.

The electrical and thermal data are valid for one thyristor half of the device.

### Blocking

Part Number	5STB 24Q2800	5STB 24Q2600	5STB 24Q2200	Conditions
$V_{SM}$	3000 V	2800 V	2400 V	$f = 5 \text{ Hz}, t_p = 10\text{ms}$
$V_{RM}$	2800 V	2600 V	2200 V	$f = 50 \text{ Hz}, t_p = 10\text{ms}$
$I_{SM}$	$\leq 400 \text{ mA}$			$V_{SM}$
$I_{RM}$	$\leq 400 \text{ mA}$			$V_{RM}$
$dV/dt_{crit}$	1000 V/ $\mu\text{s}$			@ Exp. to $0.67 \times V_{SM}$

$V_{RM}$  is equal to  $V_{SM}$  up to  $T_j = 110^\circ\text{C}$

### Mechanical data

$F_M$	Mounting force	nom.	90 kN
		min.	81 kN
		max.	108 kN
a	Acceleration		
	Device unclamped		50 m/s <sup>2</sup>
	Device clamped		100 m/s <sup>2</sup>
m	Weight		2.1 kg
$D_S$	Surface creepage distance		36 mm
$D_a$	Air strike distance		15 mm



ABB Semiconductors AG reserves the right to change specifications without notice.

# ABB

## On-state

$I_{TAVM}$	Max. average on-state	2630 A	Half sine wave, $T_C = 70^\circ\text{C}$		
$I_{TRMS}$	Max. RMS on-state current	4130 A			
$I_{TSM}$	Max. peak non-repetitive surge current	43000 A	$t_p =$	10 ms	$T_j = 125^\circ\text{C}$ After surge: $V_D = V_R = 0\text{V}$
		46000 A	$t_p =$	8.3 ms	
$I^2t$	Limiting load integral	9245 $\text{kA}^2\text{s}$	$t_p =$	10 ms	
		8781 $\text{kA}^2\text{s}$	$t_p =$	8.3 ms	
$V_T$	On-state voltage	1.35 V	$I_T =$	3000 A	$T_j = 125^\circ\text{C}$
$V_{T0}$	Threshold voltage	0.85 V	$I_T =$	1500 - 4500 A	
$r_T$	Slope resistance	0.160 $\text{m}\Omega$			
$I_H$	Holding current	50-250 mA	$T_j = 25^\circ\text{C}$		
		25-150 mA	$T_j = 125^\circ\text{C}$		
$I_L$	Latching current	100-500 mA	$T_j = 25^\circ\text{C}$		
		50-300 mA	$T_j = 125^\circ\text{C}$		

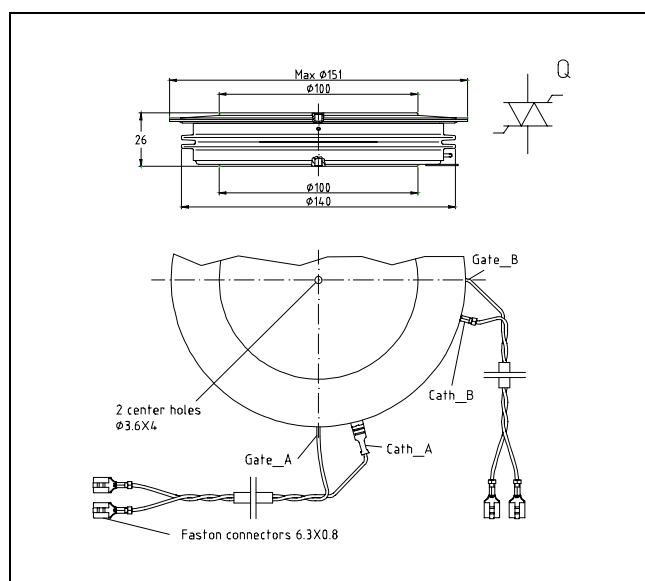
## Switching

$di/dt_{crit}$	Critical rate of rise of on-state current	250 $\text{A}/\mu\text{s}$	Cont. $f = 50\text{ Hz}$	$V_D \leq 0.67 \cdot V_{DRM}$ , $T_j = 125^\circ\text{C}$ $I_{TRM} = 3000\text{ A}$ $I_{FG} = 2\text{ A}$ , $t_r = 0.5\ \mu\text{s}$
		500 $\text{A}/\mu\text{s}$	60 sec. $f = 50\text{ Hz}$	
$t_d$	Delay time	$\leq 3.0\ \mu\text{s}$	$V_D = 0.4 \cdot V_{DRM}$	$I_{FG} = 2\text{ A}$ , $t_r = 0.5\ \mu\text{s}$
$t_q$	Turn-off time	$\leq 400\ \mu\text{s}$	$V_D \leq 0.67 \cdot V_{DRM}$ $dv_D/dt = 20\text{ V}/\mu\text{s}$	$I_{TRM} = 3000\text{ A}$ , $T_j = 125^\circ\text{C}$ $V_R > 200\text{ V}$ , $di_T/dt = -1.5\ \text{A}/\mu\text{s}$
$Q_{rr}$	Recovery charge	min	1100 $\mu\text{As}$	
		max	2000 $\mu\text{As}$	

## Triggering

$V_{GT}$	Gate trigger voltage	$\leq 2.6\text{ V}$	$T_j = 25^\circ\text{C}$
$I_{GT}$	Gate trigger current	$\leq 400\text{ mA}$	$T_j = 25^\circ\text{C}$
$V_{GD}$	Gate non-trigger voltage	$\geq 0.3\text{ V}$	$V_D = 0.4 \cdot V_{RM}$ $T_j = 125^\circ\text{C}$
$I_{GD}$	Gate non-trigger current	$\geq 10\text{ mA}$	$V_D = 0.4 \cdot V_{RM}$ $T_j = 125^\circ\text{C}$
$V_{FGM}$	Peak forward gate voltage	12 V	
$I_{FGM}$	Peak forward gate current	10 A	
$V_{RGM}$	Peak reverse gate voltage	10 V	
$P_G$	Maximum gate power loss	3 W	

**Thermal**

$T_j$	Operating junction temperature range	-40...125 °C	
$T_{stg}$	Storage temperature range	-40...150 °C	
$R_{thJC}$	Thermal resistance junction to case	20 K/kW	Anode side cooled
		20 K/kW	Cathode side cooled
		10 K/kW	Double side cooled
$R_{thCH}$	Thermal resistance case to heat sink	4 K/kW	Single side cooled
		2 K/kW	Double side cooled

**Analytical function for transient thermal impedance:**

$$Z_{thJC}(t) = \sum_{i=1}^n R_i(1 - e^{-t/\tau_i})$$

i	1	2	3	4
$R_i$ (K/kW)	6.5	1.47	1.31	0.71
$\tau_i$ (s)	0.5205	0.1075	0.0194	0.0073

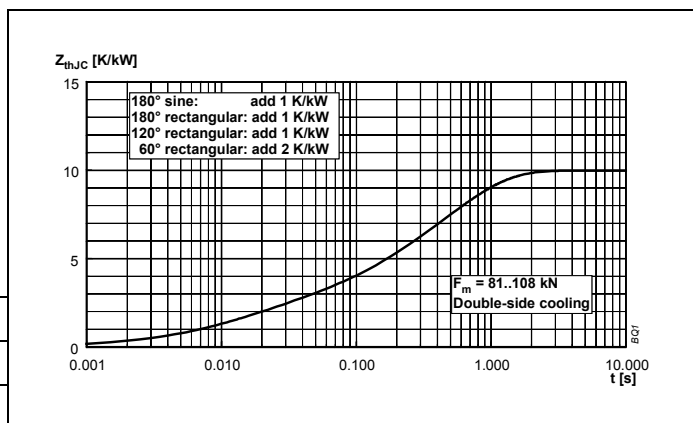

**Fig. 1** Transient thermal impedance junction to case.

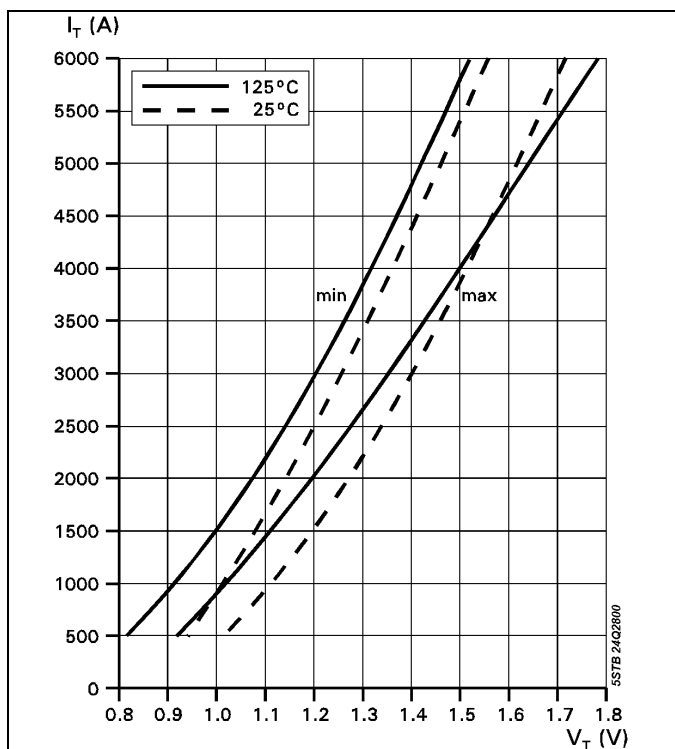

**Fig. 2** On-state characteristics.

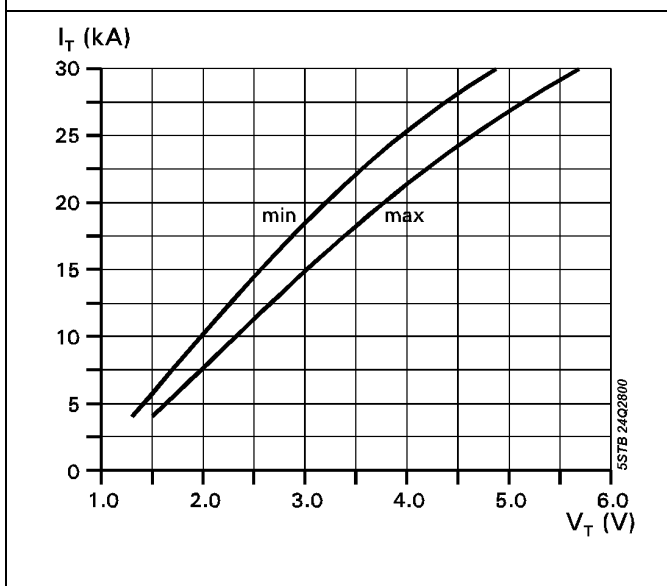

**Fig. 3** On-state characteristics.

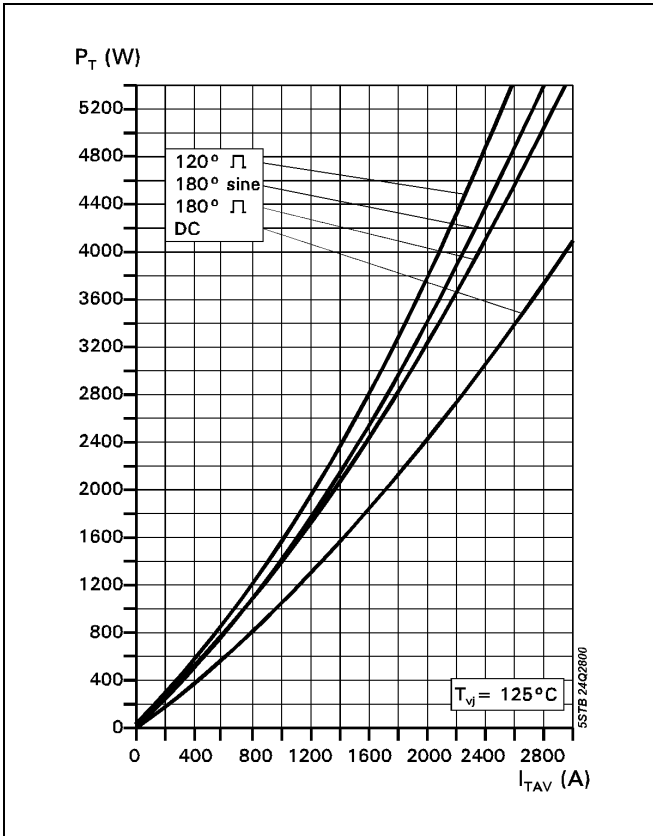

Fig. 4 On-state power dissipation vs. mean on-state current. Turn - on losses excluded.

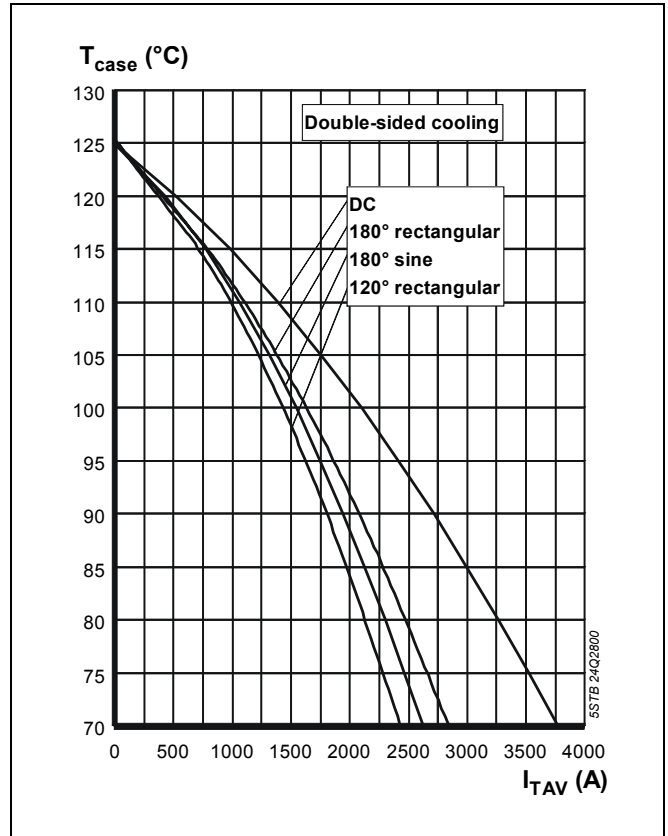

Fig. 5 Max. permissible case temperature vs. mean on-state current.

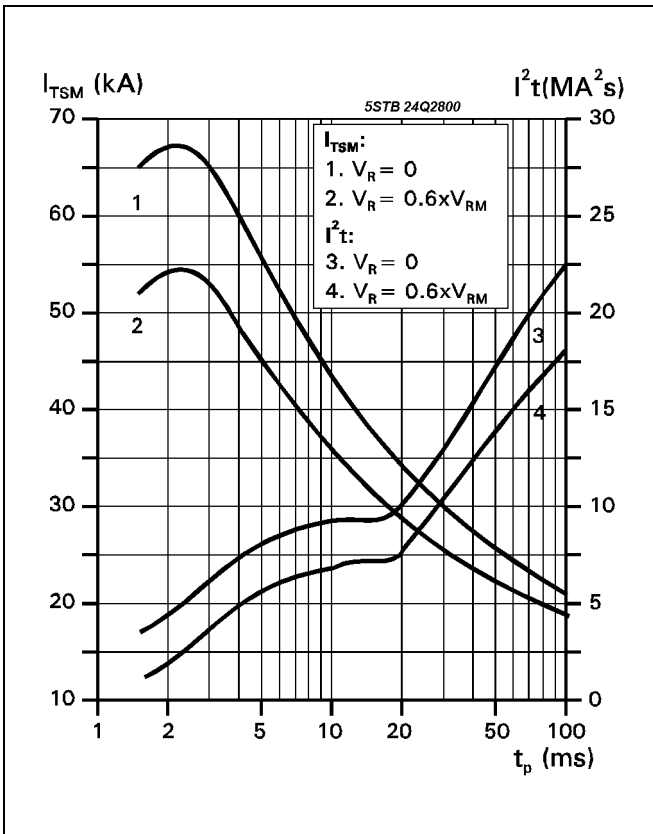

Fig. 6 Surge on-state current vs. pulse length. Half-sine wave.

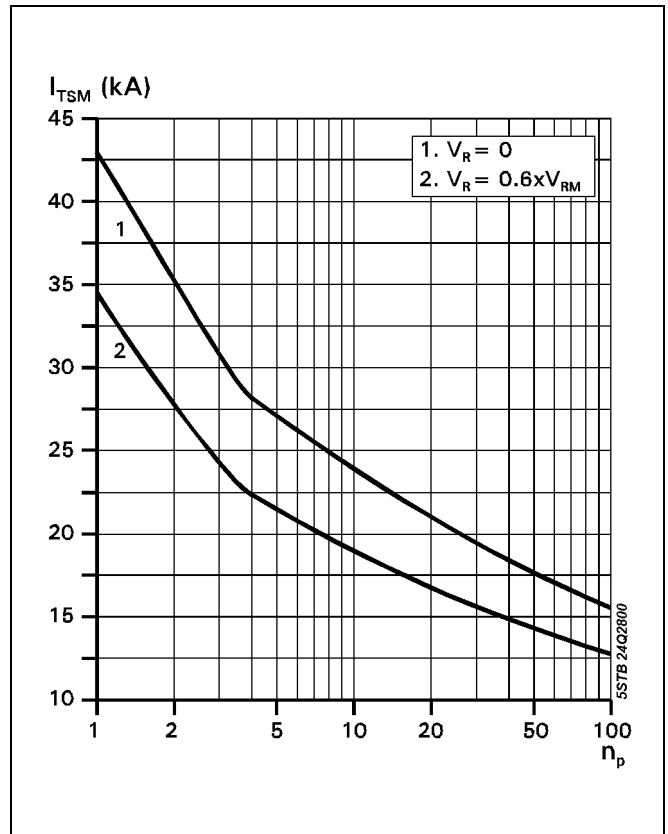

Fig. 7 Surge on-state current vs. number of pulses. Half-sine wave, 10 ms, 50Hz.

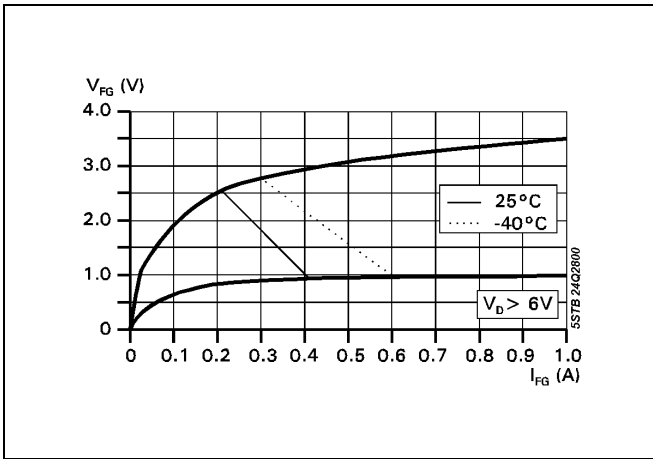

Fig. 8 Gate trigger characteristics.

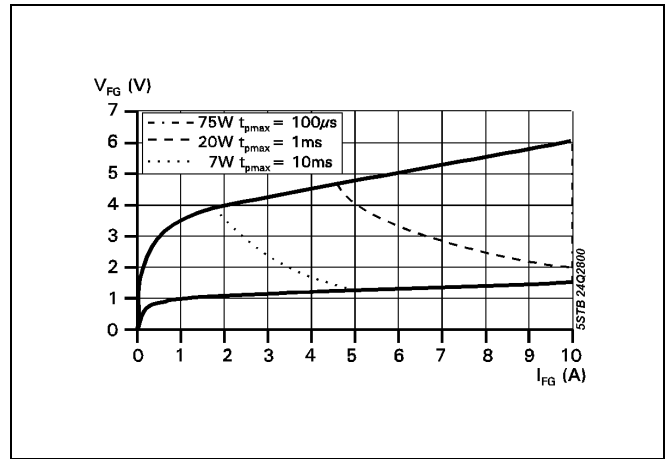

Fig. 9 Max. peak gate power loss.

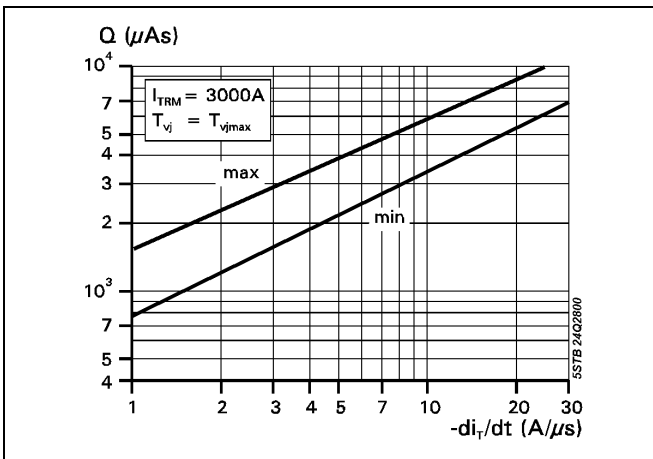

Fig. 10 Recovery charge vs. decay rate of on-state current.

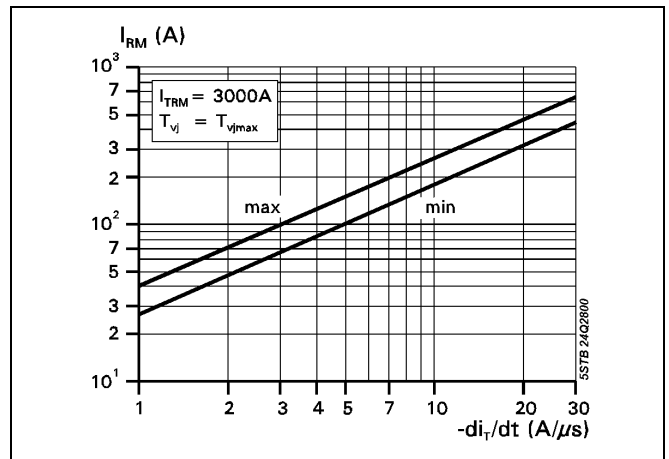

Fig. 11 Peak reverse recovery current vs. decay rate of on-state current.

ABB Semiconductors AG reserves the right to change specifications without notice.



ABB Semiconductors AG  
 Fabrikstrasse 3  
 CH-5600 Lenzburg, Switzerland

Telephone +41 (0)62 888 6419  
 Fax +41 (0)62 888 6306  
 Email [abbsem@ch.abb.com](mailto:abbsem@ch.abb.com)  
 Internet [www.abbsem.com](http://www.abbsem.com)