

2SA2166

FOR GENERAL PURPOSE HIGH CURRENT DRIVE APPLICATION
SILICON PNP EPITAXIAL TYPE

DESCRIPTION

ISAHAYA 2SA2166 is a silicon PNP epitaxial type transistor designed with high collector current, low $V_{CE(sat)}$.

FEATURE

- High collector current

$$I_{C(MAX)} = -500\text{mA}$$

- Low collector to emitter saturation voltage

$$V_{CE(sat)} < -0.4V_{max} (I_C = -150\text{mA}, I_B = -15\text{mA})$$

APPLICATION

For switching application, small type motor drive application.

MAXIMUM RATINGS ($T_a = 25^\circ\text{C}$)

記号	項目	定格値	単位
V_{CEO}	Collector to Emitter voltage	-60	V
V_{CBO}	Collector to Base voltage	-60	V
V_{EBO}	Emitter to Base voltage	-5	V
I_C	Collector current	-500	mA
P_C	Collector dissipation	200	mW
T_j	Junction temperature	150	$^\circ\text{C}$
T_{stg}	Storage temperature	-55~150	$^\circ\text{C}$

OUTLINE DRAWING

Unit: mm

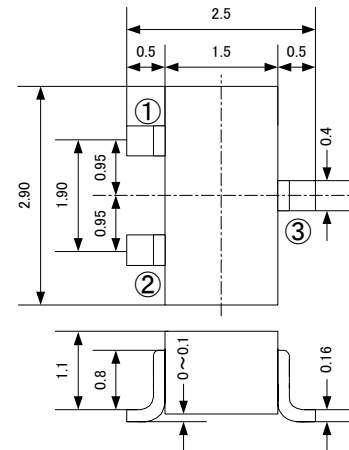

Notice: The dimension without tolerance represent central value.

TERMINAL CONNECTOR

- ①: BASE EIAJ: SC-59
- ②: EMITTER JEDEC: TO-236
- ③: COLLECTOR Resemblance

MARKING

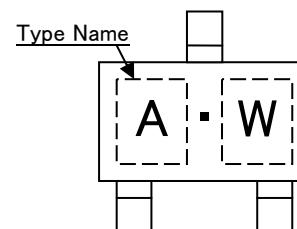

ELECTRICAL CHARACTERISTICS ($T_a = 25^\circ\text{C}$)

Symbol	Parameter	Test condition	Limits			Unit
			Min	Typ	Max	
$V_{(BR)CEO}$	C to E break down voltage	$I_C = -1\text{mA}, I_B = 0$	-60			V
$V_{(BR)CBO}$	C to B break down voltage	$I_C = -10\mu\text{A}, I_E = 0$	-60			V
$V_{(BR)EBO}$	E to B break down voltage	$I_E = -10\mu\text{A}, I_C = 0$	-5			V
I_{CBO}	Collector cut off current	$V_{CB} = -50\text{V}, I_E = 0$			-100	nA
I_{EBO}	Emitter cut off current	$V_{EB} = -3\text{V}, I_C = 0$			-100	nA
h_{FE}	DC forward current gain	$I_C = -150\text{mA}, V_{CE} = -10\text{V}$	100		300	---
$V_{CE(sat)}$	C to E saturation voltage	$I_C = -150\text{mA}, I_B = -15\text{mA}$			-0.4	V
$V_{BE(sat)}$	B to E saturation voltage	$I_C = -150\text{mA}, I_B = -15\text{mA}$			-1.3	V
f_T	Gain band width product	$I_E = 50\text{mA}, V_{CE} = -20\text{V}, f = 100\text{MHz}$	200			MHz
C_{ob}	Collector output capacitance	$V_{CB} = -10\text{V}, f = 1\text{MHz}$			8	pF

TYPICAL CHARACTERISTICS

COMMON EMITTER OUTPUT

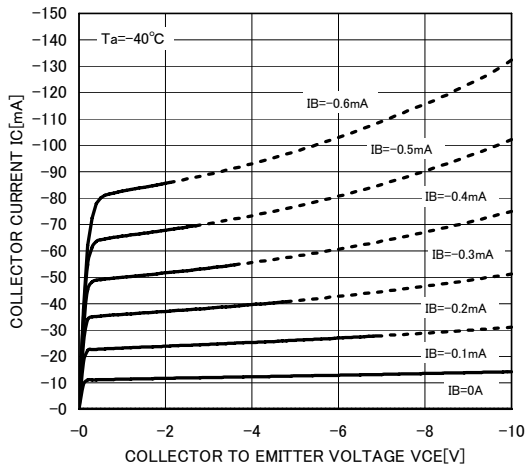

COMMON EMITTER OUTPUT

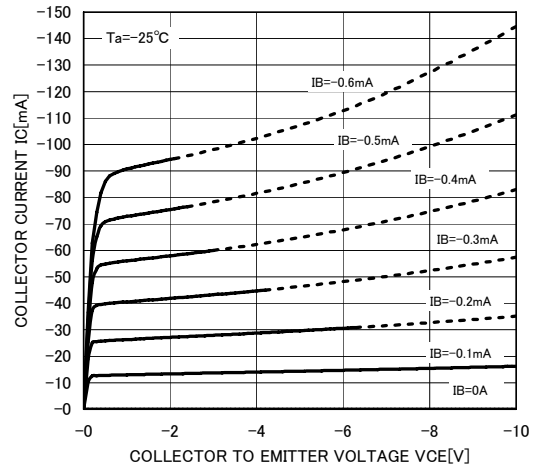

COMMON EMITTER OUTPUT

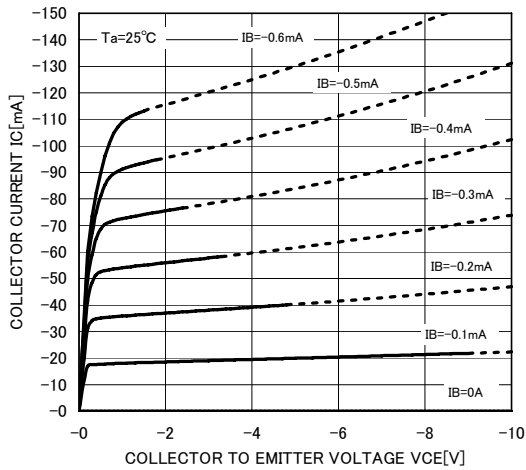

COMMON EMITTER OUTPUT

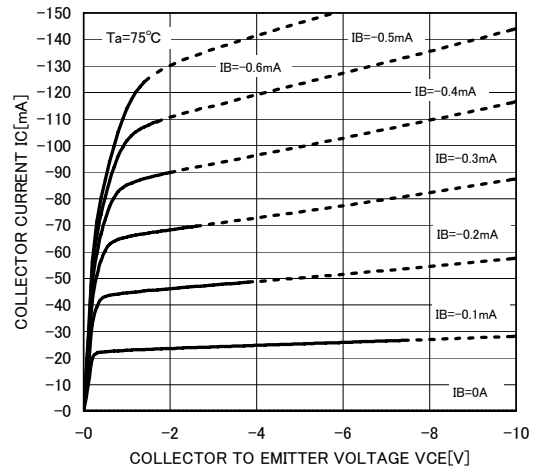

エミッタ接地出力特性

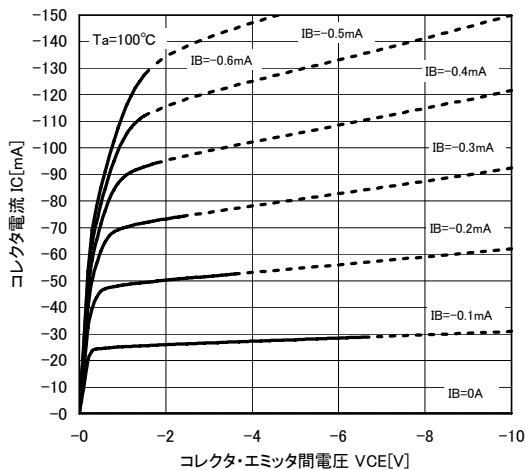

COMMON EMITTER TRANSFER

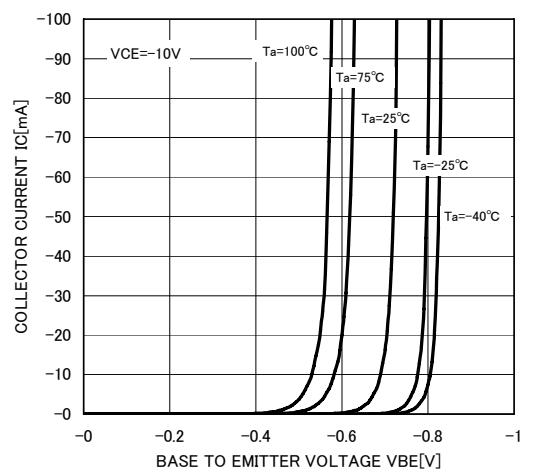

DC FORWARD CURRENT GAIN
VS. COLLECTOR CURRENT

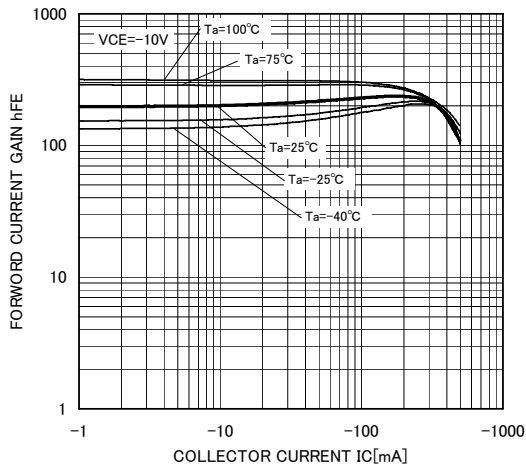

COLLECTOR TO EMITTER SATURATION VOLTAGE
VS. COLLECTOR CURRENT

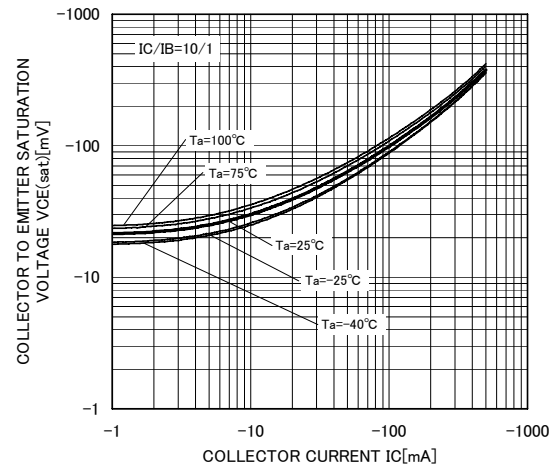

BASE TO EMITTER SATURATION VOLTAGE
VS. COLLECTOR CURRENT

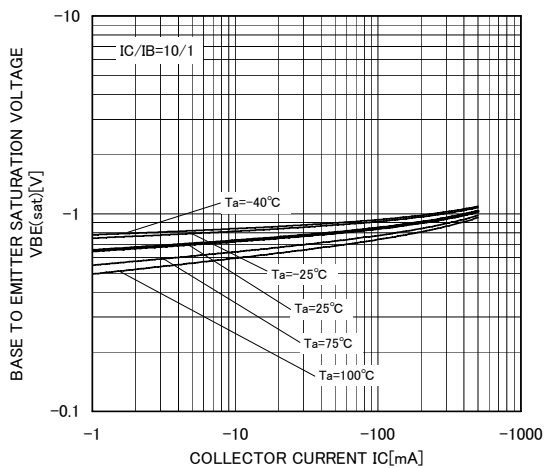

GAIN BAND WIDTH PRODUCT
VS. EMITTER CURRENT

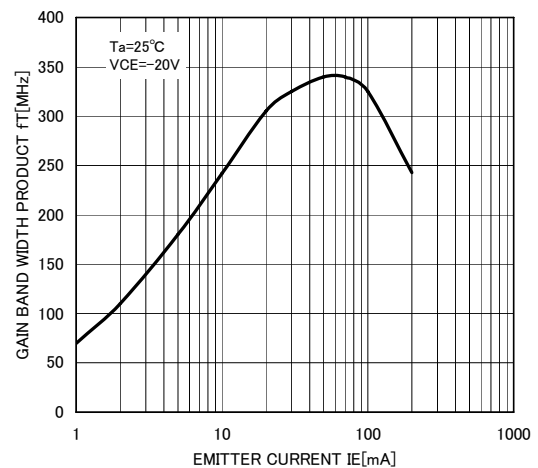

COLLECTOR OUTPUT CAPACITANCE
VS. COLLECTOR TO BASE VOLTAGE

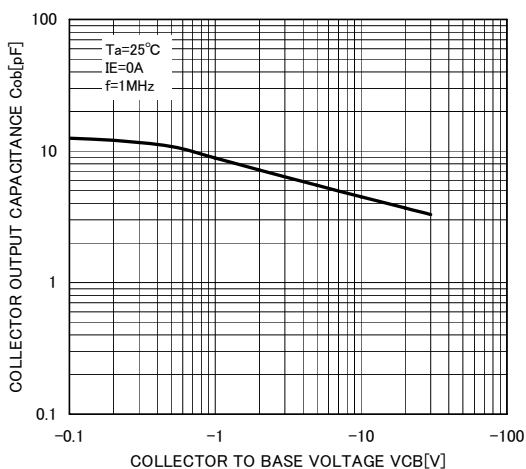

COLLECTOR DISSIPATION
VS. AMBIENT TEMPERATURE

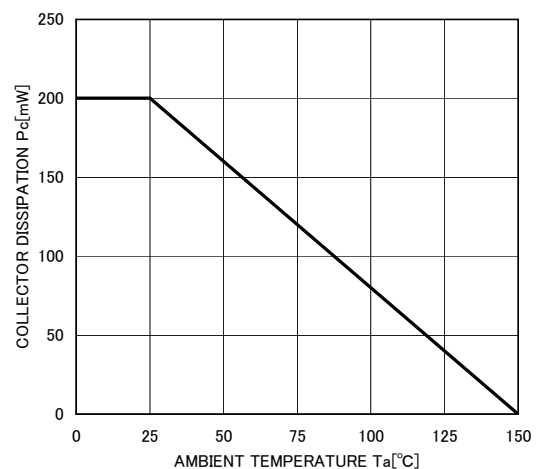



Marketing division, Marketing planning department

6-41 Tsukuba, Isahaya, Nagasaki, 854-0065 Japan

Keep safety first in your circuit designs!

•ISAHAYA Electronics Corporation puts the maximum effort into making semiconductor products better and more reliable, but there is always the possibility that trouble may occur with them. Trouble with semiconductors may lead to personal injury, fire or property damage. Remember to give due consideration to safety when making your circuit designs, with appropriate measures such as (1) placement of substitutive, auxiliary, (2) use of non-flammable material or (3) prevention against any malfunction or mishap.

Notes regarding these materials

- These materials are intended as a reference to our customers in the selection of the ISAHAYA products best suited to the customer's application; they don't convey any license under any intellectual property rights, or any other rights, belonging ISAHAYA or third party.
- ISAHAYA Electronics Corporation assumes no responsibility for any damage, or infringement of any third party's rights, originating in the use of any product data, diagrams, charts or circuit application examples contained in these materials.
- All information contained in these materials, including product data, diagrams and charts, represent information on products at the time of publication of these materials, and are subject to change by ISAHAYA Electronics Corporation without notice due to product improvements or other reasons. It is therefore recommended that customers contact ISAHAYA Electronics Corporation or an authorized ISAHAYA products distributor for the latest product information before purchasing product listed herein.
- ISAHAYA Electronics Corporation products are not designed or manufactured for use in a device or system that is used under circumstances in which human life is potentially at stake. Please contact ISAHAYA electronics corporation or an authorized ISAHAYA products distributor when considering the use of a product contained herein for any specific purposes, such as apparatus or systems for transportation, vehicular, medical, aerospace, nuclear, or undersea repeater use.
- The prior written approval of ISAHAYA Electronics Corporation is necessary to reprint or reproduce in whole or in part these materials.
- If these products or technologies are subject to the Japanese export control restrictions, they must be exported under a license from the Japanese government and cannot be imported into a country other than the approved destination. Any diversion or re-export contrary to the export control laws and regulations of Japan and/or the country of destination is prohibited.
- Please contact ISAHAYA Electronics Corporation or authorized ISAHAYA products distributor for further details on these materials or the products contained therein.