

SEMiX 302GB128Ds



SEMiX[®] 2s

SPT IGBT Modules

SEMiX 302GB128Ds

Preliminary Data

Features

- Homogeneous Si
- SPT = Soft-Punch-Through technology
- $V_{CE(sat)}$ with positive temperature coefficient
- High short circuit capability

Typical Applications

- AC inverter drives
- UPS
- Electronic welders up to 20 kHz

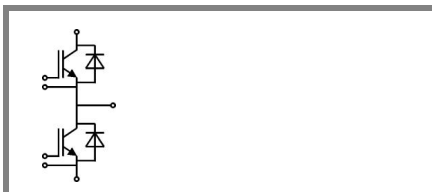

GB

Absolute Maximum Ratings		$T_{case} = 25^{\circ}C$, unless otherwise specified			
Symbol	Conditions	Values			Units
IGBT					
V_{CES}	$T_j = 25^{\circ}C$	1200			V
I_C	$T_j = 150^{\circ}C$	$T_{case} = 25^{\circ}C$	285		A
		$T_{case} = 80^{\circ}C$	200		A
I_{CRM}	$I_{CRM} = 2 \times I_{Cnom}$	300			A
V_{GES}		± 20			V
t_{psc}	$V_{CC} = 600 V$; $V_{GE} \leq 20 V$; $T_j = 125^{\circ}C$ $V_{CES} < 1200 V$	10			μs
Inverse Diode					
I_F	$T_j = 150^{\circ}C$	$T_{case} = 25^{\circ}C$	230		A
		$T_{case} = 80^{\circ}C$	160		A
I_{FRM}	$I_{FRM} = 2 \times I_{Fnom}$	300			A
I_{FSM}	$t_p = 10 ms$; sin.	$T_j = 25^{\circ}C$	1300		A
Module					
$I_{t(RMS)}$		600			A
T_{vj}		-40 ... +150			$^{\circ}C$
T_{stg}		-40 ... +125			$^{\circ}C$
V_{isol}	AC, 1 min.	4000			V

Characteristics		$T_{case} = 25^{\circ}C$, unless otherwise specified			
Symbol	Conditions	min.	typ.	max.	Units
IGBT					
$V_{GE(th)}$	$V_{GE} = V_{CE}$, $I_C = 6 mA$	4,5	5	6,5	V
I_{CES}	$V_{GE} = 0 V$, $V_{CE} = V_{CES}$			0,3	mA
V_{CE0}		$T_j = 25^{\circ}C$	1		V
		$T_j = 125^{\circ}C$	0,9		V
r_{CE}	$V_{GE} = 15 V$	$T_j = 25^{\circ}C$	6		$m\Omega$
		$T_j = 125^{\circ}C$	8		$m\Omega$
$V_{CE(sat)}$	$I_{Cnom} = 150 A$, $V_{GE} = 15 V$	$T_j = 25^{\circ}C_{chiplev.}$	1,9		V
		$T_j = 125^{\circ}C_{chiplev.}$	2,1		V
C_{ies}	$V_{CE} = 25$, $V_{GE} = 0 V$	13,8			nF
C_{oes}		0,92			nF
C_{res}		0,58			nF
Q_G	$V_{GE} = -8 V \dots +15 V$	1450			nC
$t_{d(on)}$	$R_{Gon} = 4 \Omega$	$V_{CC} = 600V$ $I_{Cnom} = 150A$	190		ns
t_r			51		ns
E_{on}	$R_{Goff} = 4 \Omega$	$T_j = 125^{\circ}C$	17		mJ
$t_{d(off)}$			466		ns
t_f			56		ns
E_{off}			16		mJ
$R_{th(j-c)}$	per IGBT	0,11			K/W

SEMiX 302GB128Ds



SEMiX® 2s

SPT IGBT Modules

SEMiX 302GB128Ds

Preliminary Data

Features

- Homogeneous Si
- SPT = Soft-Punch-Through technology
- $V_{CE(sat)}$ with positive temperature coefficient
- High short circuit capability

Typical Applications

- AC inverter drives
- UPS
- Electronic welders up to 20 kHz



GB

Characteristics		min.	typ.	max.	Units
Symbol	Conditions				
Inverse Diode					
$V_F = V_{EC}$	$I_{Fnom} = 150 \text{ A}; V_{GE} = 0 \text{ V}$		2	2,5	V
			1,8	2,3	V
					V
V_{F0}			1,1	1,45	V
			0,85	1,2	V
r_F			6	7	mΩ
			6,3	7,3	mΩ
I_{RRM}	$I_{Fnom} = 150 \text{ A}$		180		A
Q_{rr}	$di/dt = 4300 \text{ A}/\mu\text{s}$		22		μC
E_{rr}	$V_{GE} = -15 \text{ V}; V_{CC} = 600 \text{ V}$		8		mJ
$R_{th(j-c)D}$	per diode			0,19	K/W
Module					
L_{CE}			18		nH
$R_{CC'+EE'}$	res., terminal-chip	$T_{case} = 25 \text{ °C}$	0,7		mΩ
		$T_{case} = 125 \text{ °C}$	1		mΩ
$R_{th(c-s)}$	per module		0,045		K/W
M_s	to heat sink (M5)		3	5	Nm
M_t	to terminals (M6)		2,5	5	Nm
w				250	g
Temperature sensor					
R_{100}	$T_c = 100 \text{ °C}$ ($R_{25} = 5 \text{ k}\Omega$)		0,493±5%		kΩ
$B_{100/125}$	$R(T) = R_{100} \exp[B_{100/125} (1/T - 1/T_{100})]$; $T[\text{K}]; B$		3550±2%		K

This is an electrostatic discharge sensitive device (ESDS), international standard IEC 60747-1, Chapter IX.

This technical information specifies semiconductor devices but promises no characteristics. No warranty or guarantee expressed or implied is made regarding delivery, performance or suitability.

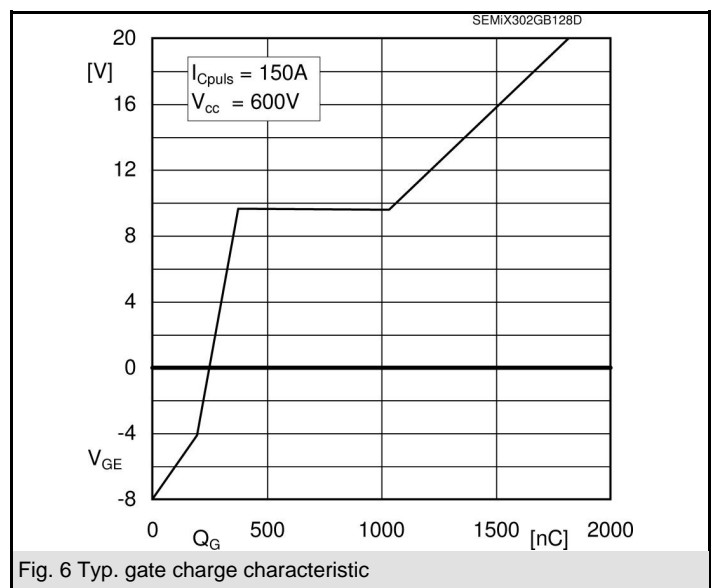
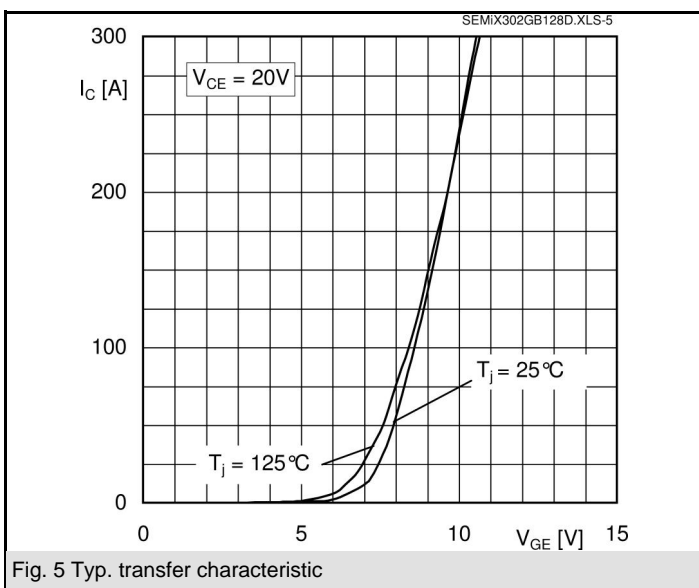
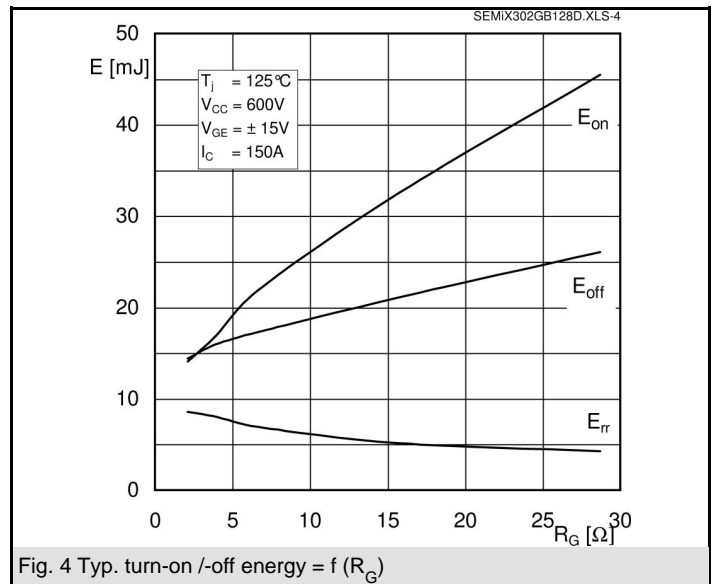
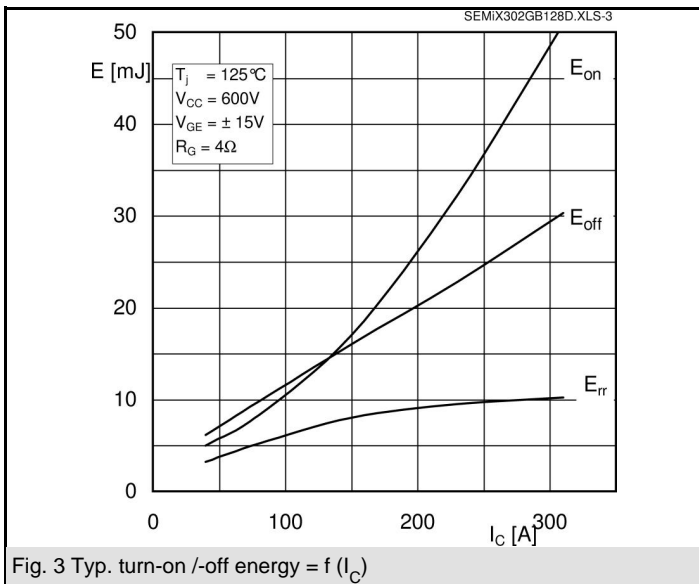
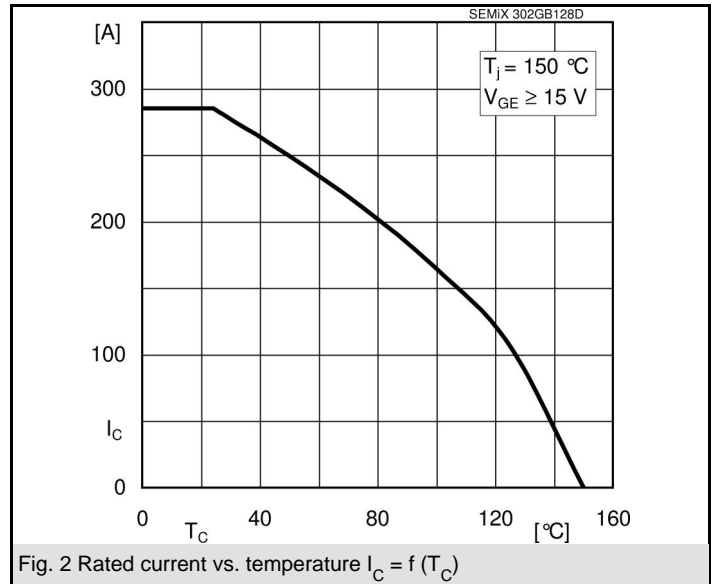
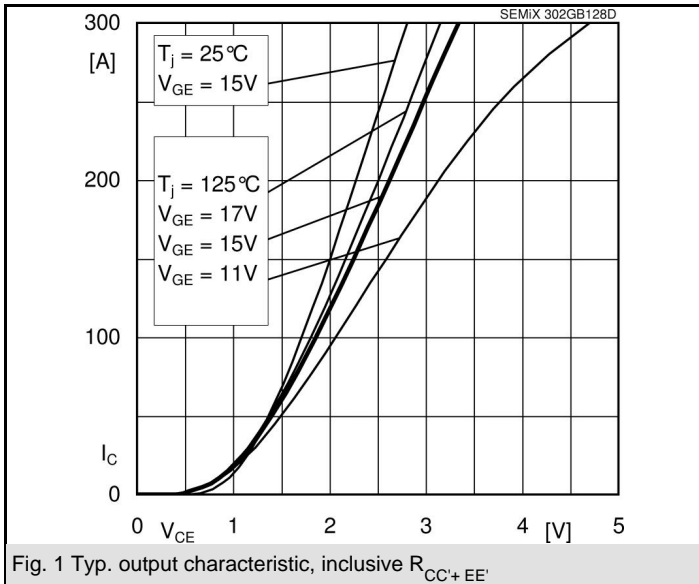

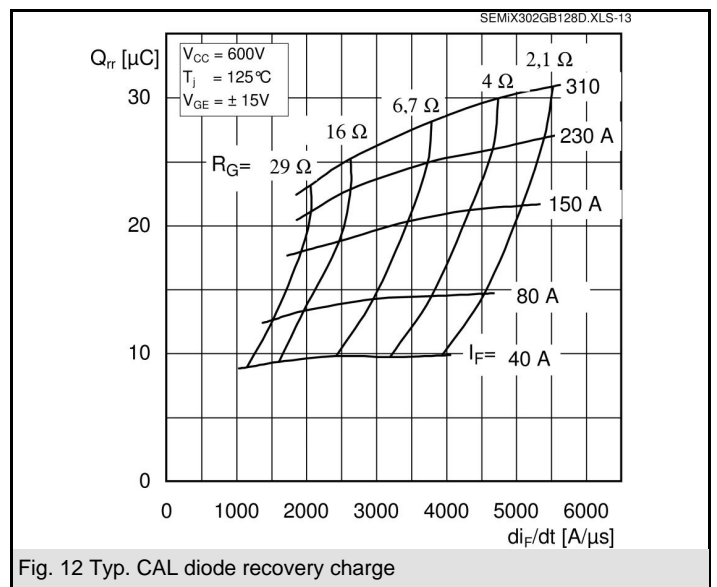
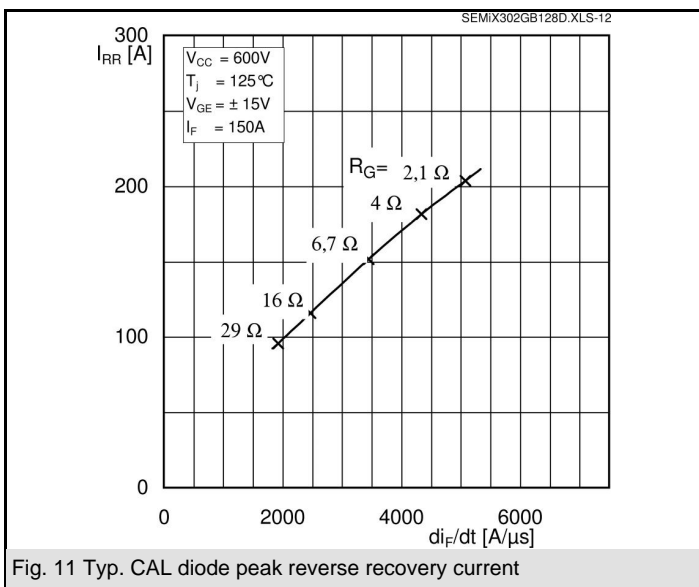
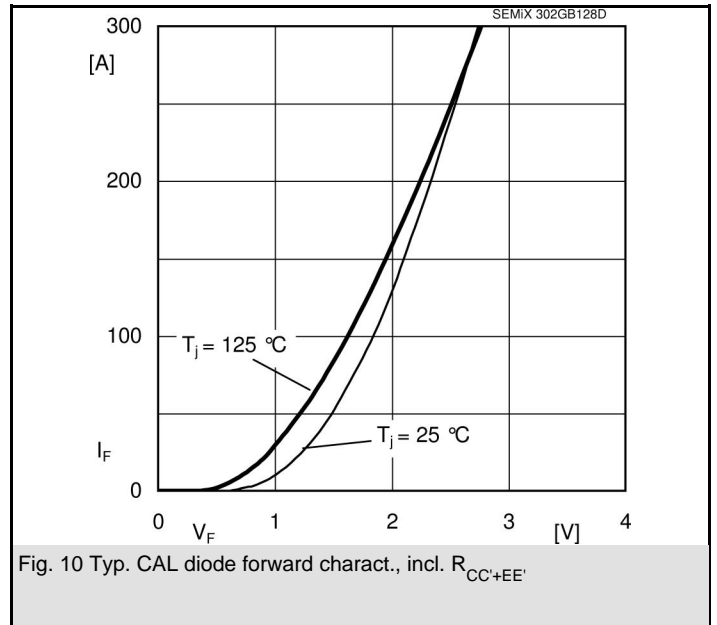
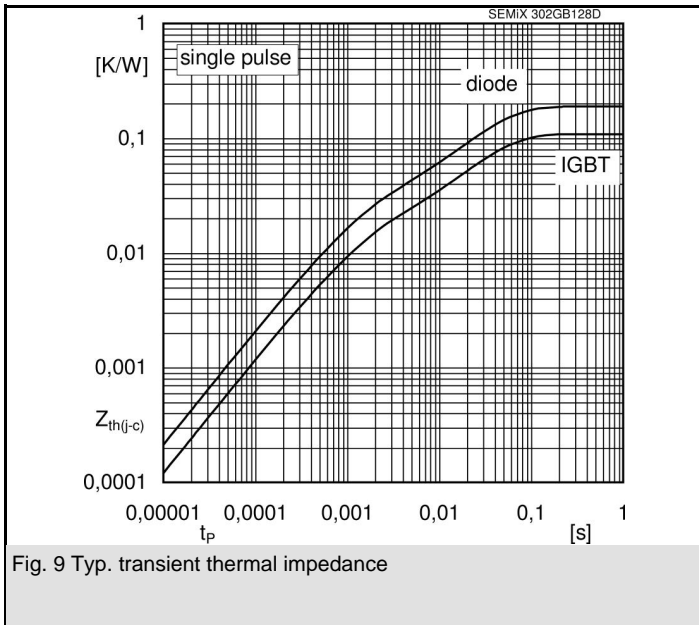
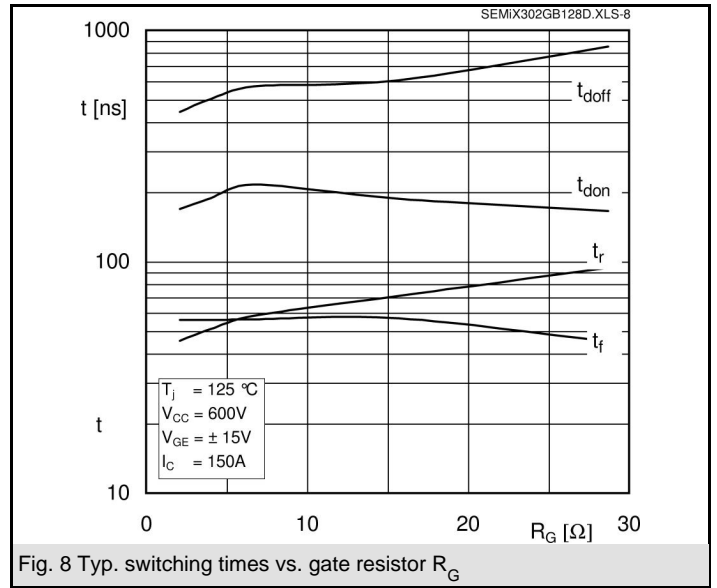
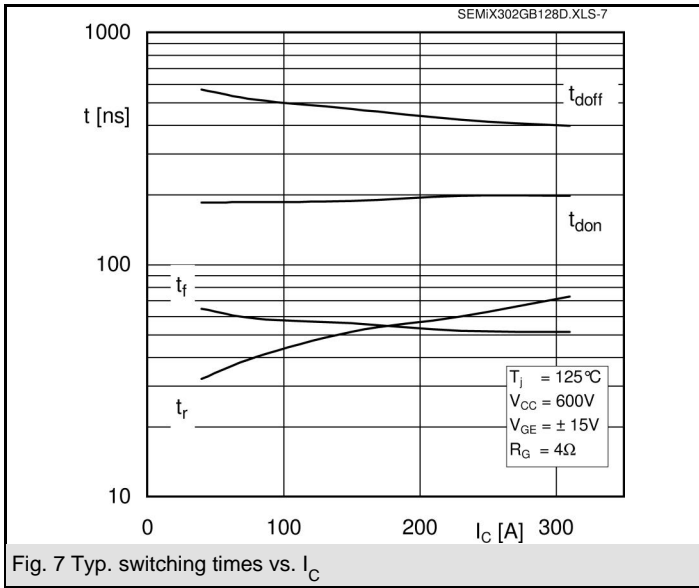

SEMiX 302GB128Ds

case: SEMiX 2s

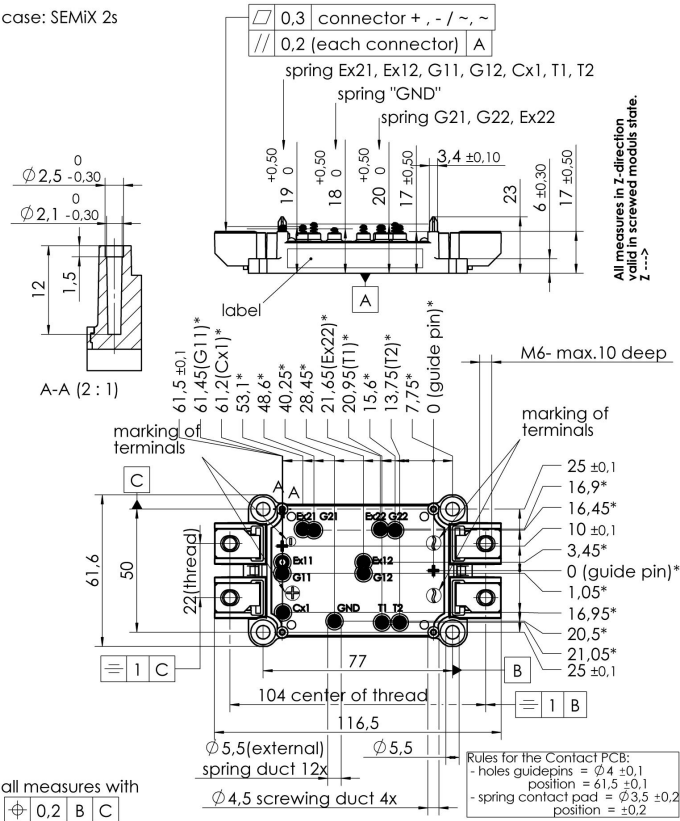

Case SEMiX 2s

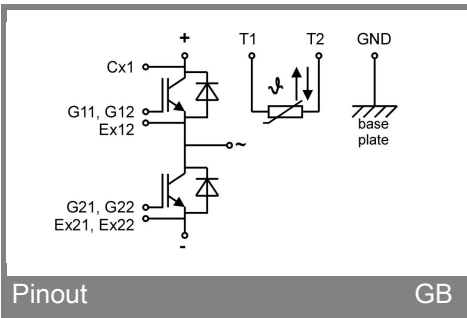

Pinout

GB