

# CEL

## NEC's EA MODULATOR INTEGRATED InGaAsP MQW DFB LASER DIODE MODULE FOR 2.5 Gb/s ULTRALONG-REACH 360, 600, 240 km DWDM APPLICATIONS

**NX8564LE  
NX8565LE  
NX8566LE  
SERIES**

### FEATURES

- **INTEGRATED ELECTROABSORPTION MODULATOR**
- **VERY LOW DISPERSION PENALTY:**
  - Over 360 km (6480 ps/nm), NX8564LE-BC/CC
  - Over 600 km (10800 ps/nm), NX8565LE-BC/CC
  - Over 240 km (4320 ps/nm), NX8566LE-BC/CC
- **LOW MODULATION VOLTAGE**
- **AVAILABLE FOR DWDM WAVELENGTH  
BASED ON ITU-T RECOMMENDATION**  
100 GHz grid, refer to **ORDERING INFORMATION**

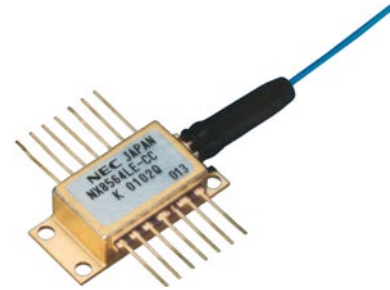

### DESCRIPTION

NEC's NX8564/8565/8566LE Series is an Electro-Absorption (EA) modulator integrated, 1550 nm Multiple Quantum Well (MQW) structured Distributed Feed-Back (DFB) laser diode. The module is capable of 2.5 Gb/s applications of over 360 km, 600 km, 240 km ultralong-reach and available for Dense Wavelength Division Multiplexing (DWDM) wavelengths based on ITU-T recommendations, enabling a wide range of applications.

**PACKAGE DIMENSIONS** (Units in mm, unless otherwise specified  $\pm 0.2\text{mm}$ )

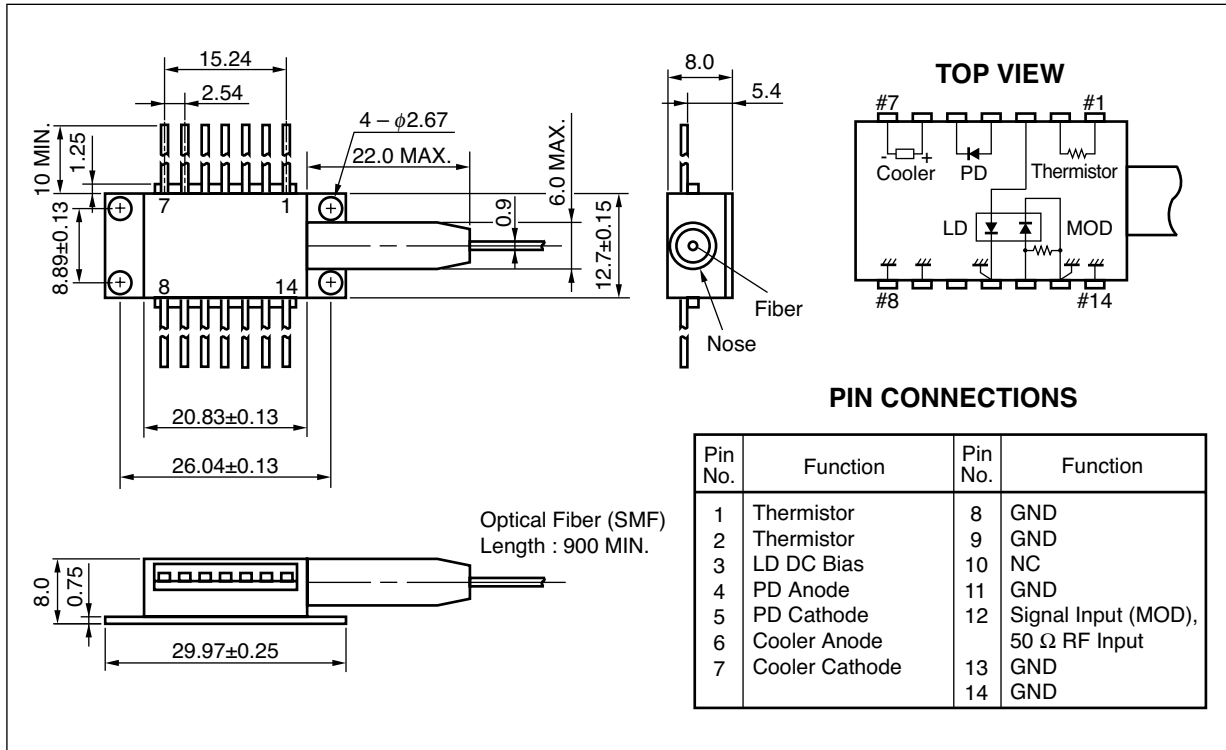

**OPTICAL FIBER CHARACTERISTICS**

PARAMETER	SPECIFICATION	UNIT
Mode Field Diameter	9.3±0.5	μm
Cladding Diameter	125±1	μm
Tight Buffer Diameter	900±100	μm
Cut-off Wavelength	< 1270	nm
Attenuation 1525 to 1575 nm	< 0.3	dB/km
Minimum Fiber Bending Radius	30	mm
Fiber Length	900 MIN.	mm
Flammability	UL1581 VW-1	

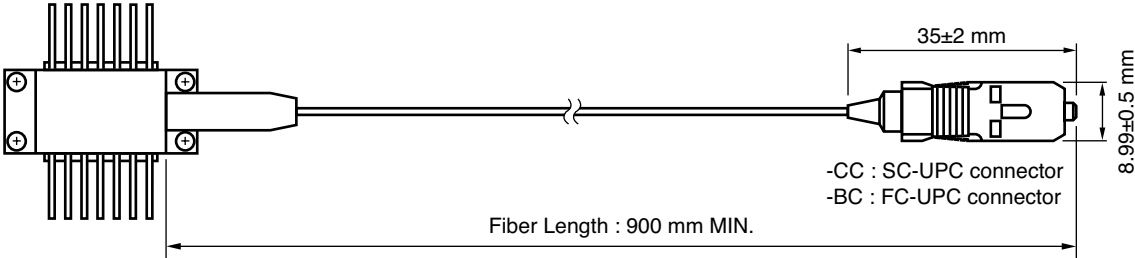

**ORDERING INFORMATION**

PART NUMBER	PACKAGING
NX8564-AZ*	Butterfly Package
NX8565-AZ*	
NX8566-AZ*	

**\*NOTE:**

Please refer to the last page of this data sheet, "Compliance with EU Directives" for Pb-Free RoHS Compliance Information.

NX856□LE□□□-□□

CC : SC-UPC connector  
 BC : FC-UPC connector (option)

Without wavelength code : Wavelength is a certain point between  
 1528 to 1565 nm, 1579 to 1609 nm

With wavelength code : Refer to **Table A**

4 : 360 km (6480 ps/nm)  
 5 : 600 km (10800 ps/nm)  
 6 : 240 km (4320 ps/nm)

**Table A: DWDM wavelength base on ITU-T recommendations (@ T<sub>LD</sub> = T<sub>set</sub>) (1/2)**

Wavelength Code	ITU-T Wavelength <sup>*1</sup> (nm)	Frequency (THz)	Wavelength Code	ITU-T Wavelength <sup>*1</sup> (nm)	Frequency (THz)
287	1528.77	196.10	485	1548.51	193.60
295	1529.55	196.00	493	1549.31	193.50
303	1530.33	195.90	501	1550.11	193.40
311	1531.11	195.80	509	1550.91	193.30
318	1531.89	195.70	517	1551.72	193.20
326	1532.68	195.60	525	1552.52	193.10
334	1533.46	195.50	533	1553.32	193.00
342	1534.25	195.40	541	1554.13	192.90
350	1535.03	195.30	549	1554.94	192.80
358	1535.82	195.20	557	1555.74	192.70
366	1536.60	195.10	565	1556.55	192.60
373	1537.39	195.00	573	1557.36	192.50
381	1538.18	194.90	581	1558.17	192.40
389	1538.97	194.80	589	1558.98	192.30
397	1539.76	194.70	597	1559.79	192.20
405	1540.55	194.60	606	1560.60	192.10
413	1541.34	194.50	614	1561.41	192.00
421	1542.14	194.40	622	1562.23	191.90
429	1542.93	194.30	630	1563.04	191.80
437	1543.73	194.20	745	1574.54	190.40
445	1544.52	194.10	753	1575.36	190.30
453	1545.32	194.00	761	1576.19	190.20
461	1546.11	193.90	770	1577.02	190.10
469	1546.91	193.80	778	1577.85	190.00
477	1547.71	193.70	786	1578.68	189.90

\*1 The value which omitted and computed the 3rd place below the decimal point

**Table A: DWDM wavelength base on ITU-T recommendations (@  $T_{LD} = T_{set}$ ) (1/2)**

Wavelength Code	ITU-T Wavelength *1 (nm)	Frequency (THz)	Wavelength Code	ITU-T Wavelength *1 (nm)	Frequency (THz)
795	1579.51	189.80	946	1594.64	188.00
803	1580.35	189.70	954	1595.48	187.90
811	1581.18	189.60	963	1596.33	187.80
820	1582.01	189.50	971	1597.18	187.70
828	1582.85	189.40	980	1598.04	187.60
836	1583.69	189.30	988	1598.89	187.50
845	1584.52	189.20	997	1599.74	187.40
853	1585.36	189.10	6006	1600.60	187.30
862	1586.20	189.00	6014	1601.45	187.20
870	1587.04	188.90	6023	1602.31	187.10
878	1587.88	188.80	6031	1603.16	187.00
887	1588.72	188.70	6040	1604.02	186.90
895	1589.56	188.60	6048	1604.88	186.80
904	1590.41	188.50	6057	1605.74	186.70
912	1591.25	188.40	6066	1606.60	186.60
921	1592.10	188.30	6074	1607.46	186.50
929	1592.94	188.20	6083	1608.32	186.40
937	1593.79	188.10			

\*1 The value which omitted and computed the 3rd place below the decimal point

**ABSOLUTE MAXIMUM RATINGS**

PARAMETER	SYMBOL	RATINGS	UNIT
Optical Output Power from Fiber	$P_i$	10	mW
Forward Current of LD	$I_{FLD}$	150	mA
Reverse Voltage of LD	$V_{RLD}$	2.0	V
Forward Voltage of Modulator	$V_{FEA}$	1	V
Reverse Voltage of Modulator	$V_{REA}$	5	V
Forward Current of PD	$I_{FPD}$	1	mA
Reverse Voltage of PD	$V_{RPD}$	10	V
Cooler Current	$I_c$	1.5	A
Cooler Voltage	$V_c$	2.5	V
Operating Case Temperature	$T_c$	-20 to +70	°C
Storage Temperature	$T_{stg}$	-40 to +85	°C
Lead Soldering Temperature	$T_{sld}$	260 (10 sec.)	°C

**ELECTRO-OPTICAL CHARACTERISTICS** ( $T_{LD} = T_{set}$ ,  $T_C = -20$  to  $+70^{\circ}C$ , unless otherwise specified)

PARAMETER	SYMBOL	CONDITIONS	MIN.	TYP.	MAX.	UNIT
Laser Set Temperature	$T_{set}$	*1	20		35	$^{\circ}C$
Operating Current	$I_{op}$		50	60	80	mA
Modulation Center Voltage	$V_{center}$	Under modulation *2	-1.5	-1.2	-0.5	V
Modulation Voltage	$V_{mod}$	Under modulation *2		2	3	V
Forward Voltage of LD	$V_{FLD}$	$I_{FLD} = I_{op}$		1.6	2.0	V
Threshold Current	$I_{th}$			7	20	mA
Optical Output Power from Fiber	$P_f$	$I_{FLD} = I_{op}$ , Under modulation *2 (NX8564/65LE Series)	-5	-2		dBm
		$I_{FLD} = I_{op}$ , Under modulation *2 (NX8566LE Series)	0	1		
Peak Emission Wavelength	$\lambda_p$	$I_{FLD} = I_{op}$ , $V_{EA} = 0$ V	1528	ITU-T *3	1565	nm
			1574		1609	
Side Mode Suppression Ratio	SMSR	$I_{FLD} = I_{op}$ , $V_{EA} = 0$ V	30	> 37		dB
Extinction Ratio	ER	$I_{FLD} = I_{op}$ , Under modulation *2	10	> 11		dB
Rise Time	$t_r$	$I_{FLD} = I_{op}$ , 20-80%, Under modulation *2		70	125	ps
Fall Time	$t_f$	$I_{FLD} = I_{op}$ , 80-20%, Under modulation *2		70	125	ps
Dispersion Penalty	DP	$I_{FLD} = I_{op}$ , Under modulation *2,4		< 1.5	2.0	dB
Isolation	$I_s$		23			dB
Relative Intensity Noise	RIN	10 MHz to 10 GHz, $V_{EA} = 0$ V, $I_{FLD} = I_{op}$		< -135	-130	dB/Hz
Input Return Loss	$S_{11}$	$I_{FLD} = I_{op}$ , $V_{EA} = -1$ V, 50 $\Omega$ , $f = 130$ MHz to 2 GHz			-8	dB
		$I_{FLD} = I_{op}$ , $V_{EA} = -1$ V, 50 $\Omega$ , $f = 2$ to 2.5 GHz			-5	

- \*1 NX8564/65/66LE Series :  $T_{set}$  is a certain point between 20 and 35 $^{\circ}C$   
 NX8564/65/66LExxx Series :  $T_{set}$  is set at a certain point between 20 and 35 $^{\circ}C$  for ITU-T grid wavelength
- \*2 NX8564LE : C-band 360 km, L-band 288 km (6480 ps/nm) SMF under modulation  
 NX8565LE : C-band 600 km, L-band 480 km (10800 ps/nm) SMF under modulation  
 NX8566LE : C-band 240 km, L-band 192 km (4320 ps/nm) SMF under modulation  
 2.48832 Gb/s, PRBS 2<sup>23</sup>-1,  $V_{EA} = V_{center} \pm 1/2V_{mod}$ ,  $I_{FLD} = I_{op}$ ,  $T_{LD} = T_{set}$ , NEC Test System  
 $V_{center}$  : a certain point between -1.5 and -0.5 V  
 $V_{mod}$  : a certain point 3 V or below  
 $I_{op}$  : a certain point between 50 and 80 mA
- \*3 Available for DWDM wavelengths based on ITU-T recommendations (100 GHz grid).  
 Please refer to **ORDERING INFORMATION**.
- \*4 BER = 10<sup>-10</sup>

**ELECTRO-OPTICAL CHARACTERISTICS**

(Applicable to Monitor PD: T<sub>LD</sub> = T<sub>set</sub>, T<sub>c</sub> = -20 to +70°C, unless otherwise specified)

PARAMETER	SYMBOL	CONDITIONS	MIN.	TYP.	MAX.	UNIT
Monitor Current	I <sub>m</sub>	V <sub>RPD</sub> = 5 V, I <sub>FLD</sub> = I <sub>op</sub> , V <sub>EA</sub> = 0 V	20	100	1000	μA
Dark Current	I <sub>D</sub>	V <sub>RPD</sub> = 5 V, V <sub>EA</sub> = 0 V			10	nA
Terminal Capacitance	C <sub>t</sub>	V <sub>RPD</sub> = 5 V, f = 1 MHz			15	pF
Tracking Error	γ <sup>-1</sup>	I <sub>m</sub> = const.			0.5	dB

\*1 Tracking Error: γ

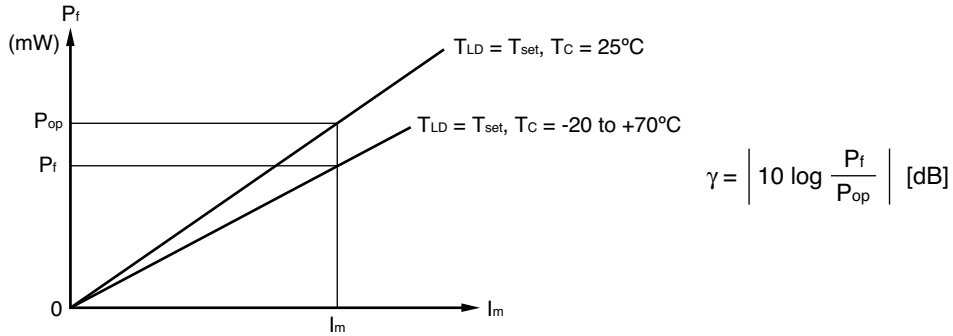

**ELECTRO-OPTICAL CHARACTERISTICS**

(Applicable to Thermistor and TEC: T<sub>c</sub> = -20 to +70°C)

PARAMETER	SYMBOL	CONDITIONS	MIN.	TYP.	MAX.	UNIT
Thermistor Resistance	R	T <sub>LD</sub> = 25°C	9.5	10.0	10.5	kΩ
B Constant	B		3350	3450	3550	K
TEC Current	I <sub>c</sub>	T <sub>LD</sub> = T <sub>set</sub>			1.2	A
TEC Voltage	V <sub>c</sub>	T <sub>LD</sub> = T <sub>set</sub>			2.4	V



**ELECTRO-OPTICAL CHARACTERISTICS** (T<sub>LD</sub> = T<sub>set</sub>, T<sub>c</sub> = 25°C, unless otherwise specified)

OPTICAL OUTPUT POWER FROM FIBER (CW) vs. FORWARD CURRENT

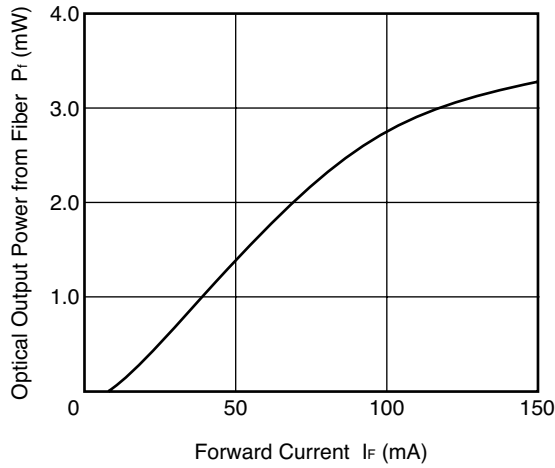

FORWARD CURRENT vs. FORWARD VOLTAGE

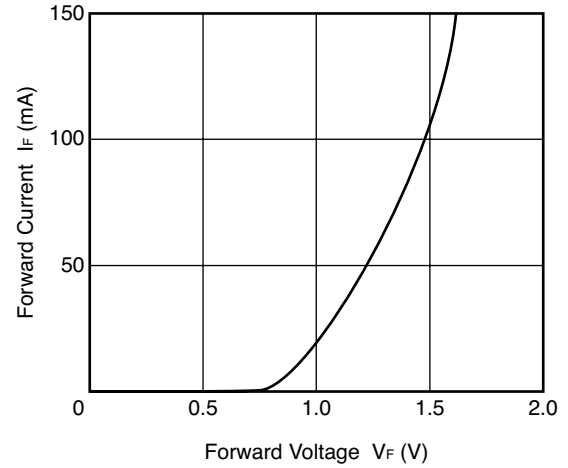

EXTINCTION RATIO vs. MODULATOR VOLTAGE

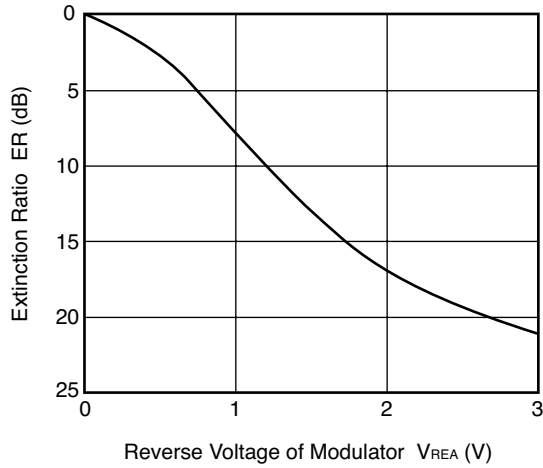

SPECTRUM

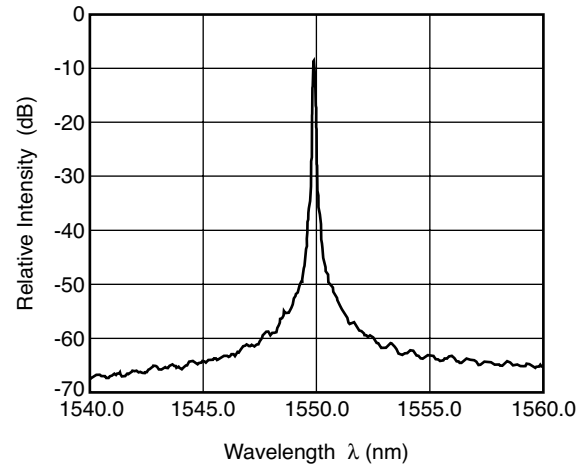

THERMISTOR RESISTANCE vs. AMBIENT TEMPERATURE

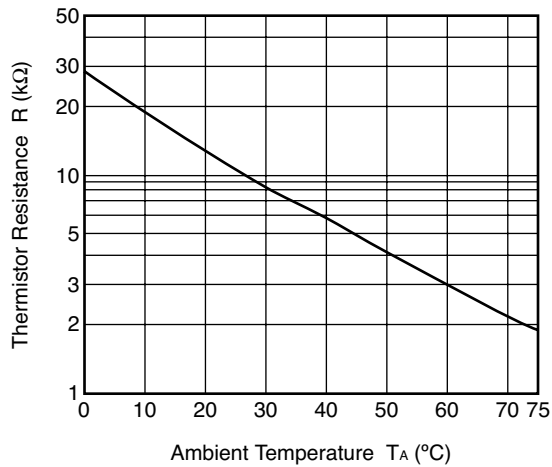

**Remark** The graphs indicate nominal characteristics.

### 600 km STANDARD FIBER TRANSMISSION EXAMPLE (NX8565LE Series)

#### Test Setup

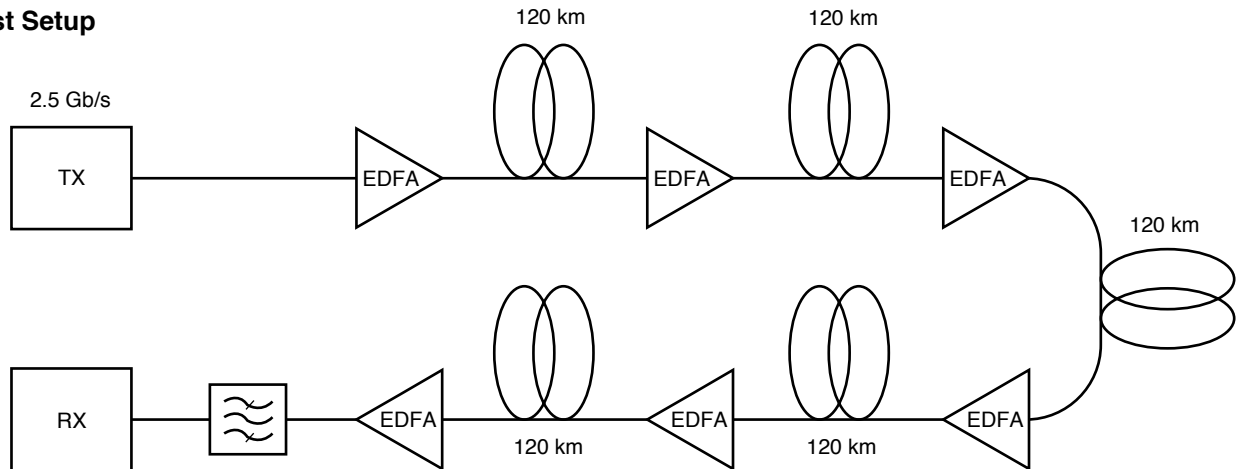

ERROR RATE CHARACTERISTICS

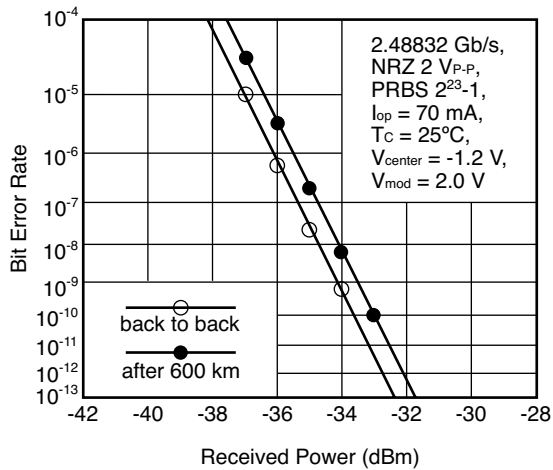

EYE DIAGRAM

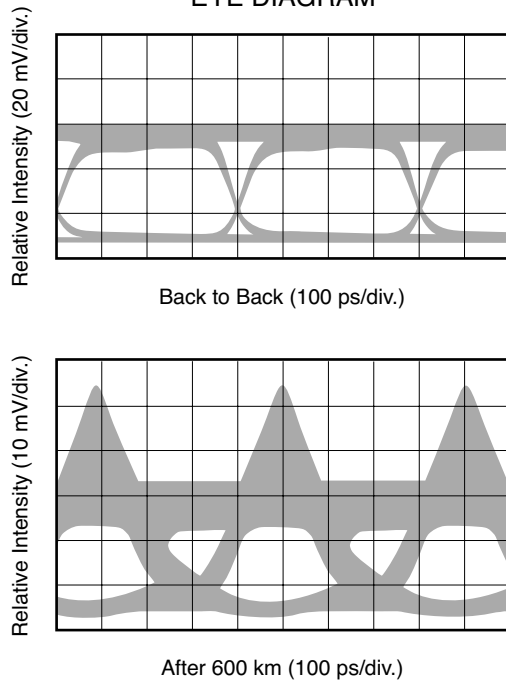

**Remark** The graphs indicate nominal characteristics.

**Life Support Applications**

These NEC products are not intended for use in life support devices, appliances, or systems where the malfunction of these products can reasonably be expected to result in personal injury. The customers of CEL using or selling these products for use in such applications do so at their own risk and agree to fully indemnify CEL for all damages resulting from such improper use or sale.

Subject: Compliance with EU Directives

CEL certifies, to its knowledge, that semiconductor and laser products detailed below are compliant with the requirements of European Union (EU) Directive 2002/95/EC Restriction on Use of Hazardous Substances in electrical and electronic equipment (RoHS) and the requirements of EU Directive 2003/11/EC Restriction on Penta and Octa BDE.

CEL Pb-free products have the same base part number with a suffix added. The suffix –A indicates that the device is Pb-free. The –AZ suffix is used to designate devices containing Pb which are exempted from the requirement of RoHS directive (\*). In all cases the devices have Pb-free terminals. All devices with these suffixes meet the requirements of the RoHS directive.

This status is based on CEL's understanding of the EU Directives and knowledge of the materials that go into its products as of the date of disclosure of this information.

Restricted Substance per RoHS	Concentration Limit per RoHS (values are not yet fixed)	Concentration contained in CEL devices	
		-A	-AZ
Lead (Pb)	< 1000 PPM	Not Detected	(*)
Mercury	< 1000 PPM	Not Detected	
Cadmium	< 100 PPM	Not Detected	
Hexavalent Chromium	< 1000 PPM	Not Detected	
PBB	< 1000 PPM	Not Detected	
PBDE	< 1000 PPM	Not Detected	

If you should have any additional questions regarding our devices and compliance to environmental standards, please do not hesitate to contact your local representative.

Important Information and Disclaimer: Information provided by CEL on its website or in other communications concerning the substance content of its products represents knowledge and belief as of the date that it is provided. CEL bases its knowledge and belief on information provided by third parties and makes no representation or warranty as to the accuracy of such information. Efforts are underway to better integrate information from third parties. CEL has taken and continues to take reasonable steps to provide representative and accurate information but may not have conducted destructive testing or chemical analysis on incoming materials and chemicals. CEL and CEL suppliers consider certain information to be proprietary, and thus CAS numbers and other limited information may not be available for release.

In no event shall CEL's liability arising out of such information exceed the total purchase price of the CEL part(s) at issue sold by CEL to customer on an annual basis.

See CEL Terms and Conditions for additional clarification of warranties and liability.