



SANYO Semiconductors DATA SHEET

LC74736PT — CMOS IC On-Screen Display Controller

Overview

The LC74736PT is an on-screen display CMOS IC that displays characters and patterns on a TV screen under the control of a microcontroller.

For QVGA display, the LC74736PT supports the use of both a 16×16 dot character font and a 16×16 dot graphic font with 16 colors.

For WVGA display, the LC74736PT supports the use of both a 24×32 dot character font and a 24×32 dot graphic font with 16 colors.

The LC74736PT can also implement extremely varied displays by the use of an external ROM.

The LC74736PT supports both QVGA (480×234) and WVGA (800×480).

Features

(1) Screen structure

Main: 2 screens (1 screen for WVGA display)

30 characters \times 15 lines (up to 450 characters) on a QVGA panel

33 characters \times 15 lines (up to 495 characters) on a WVGA panel

(Up to 34 characters \times 18 lines)

Wallpaper display screen:

QVGA mode: maximum Permanent repetition of a 4×4 (horizontal \times vertical) character pattern

WVGA mode: maximum Permanent repetition of a 2×2 (horizontal \times vertical) character pattern

- Any and all SANYO Semiconductor Co.,Ltd. products described or contained herein are, with regard to "standard application", intended for the use as general electronics equipment (home appliances, AV equipment, communication device, office equipment, industrial equipment etc.). The products mentioned herein shall not be intended for use for any "special application" (medical equipment whose purpose is to sustain life, aerospace instrument, nuclear control device, burning appliances, transportation machine, traffic signal system, safety equipment etc.) that shall require extremely high level of reliability and can directly threaten human lives in case of failure or malfunction of the product or may cause harm to human bodies, nor shall they grant any guarantee thereof. If you should intend to use our products for applications outside the standard applications of our customer who is considering such use and/or outside the scope of our intended standard applications, please consult with us prior to the intended use. If there is no consultation or inquiry before the intended use, our customer shall be solely responsible for the use.
- Specifications of any and all SANYO Semiconductor Co.,Ltd. products described or contained herein stipulate the performance, characteristics, and functions of the described products in the independent state, and are not guarantees of the performance, characteristics, and functions of the described products as mounted in the customer's products or equipment. To verify symptoms and states that cannot be evaluated in an independent device, the customer should always evaluate and test devices mounted in the customer's products or equipment.

(2) Character structure

QVGA mode: About 9MHz

16 dots (horizontal) × 16 dots (vertical): Character display

16 dots (horizontal) × 16 dots (vertical): Graphic glyph display

WVGA mode: About 33.2MHz

24 dots (horizontal) × 32 dots (vertical): Character display

24 dots (horizontal) × 32 dots (vertical): Graphic glyph display

Character display clock:

LC oscillator (about 10MHz)

External clock signal input (up to 40MHz)

Built-in PLL (VCO) (7 to 40MHz)

(3) Number of characters

QVGA mode

Up to 16384 characters when an external 16-bit 16M ROM is used.

WVGA mode

Up to 4096 characters when an external 16-bit 16M ROM is used.

No internal ROM

Internal character RAM QVGA: 4 characters, WVGA: 1 character

(4) Character sizes: Four horizontal sizes (1×, 2×, 3×, and 4×)

Four vertical sizes (1×, 2×, 3×, and 4×)

(The character size is specified in line units.)

(5) Display start positions: 1024 positions in the horizontal direction and 512 positions in the vertical direction.

Setting units: Horizontal: 1 dot (in screen units)

Vertical: 1 dot (in screen units)

(6) Display functions

• Blinking specification (in character units)

Period: 1/64, 1/32, and 1/16 of the vertical sync signal (in screen units)

Duty: Fixed at 50%

• Box (raised or recessed) display

Raised/recessed specification (in character units)

Left: Off/on specification (in character units)

Right: Off/on specification (in character units)

Top: Off/on specification (in character units)

Bottom: Off/on specification (in character units)

• Border specification (in line units): Only valid with glyphs from the character font.

(7) Color specification

Character

• Character color (in character units): 1 of 16 colors can be specified.

• Character background color (in character units): 1 of 16 colors can be specified.

• Border color (in line units): 1 of 16 colors can be specified.

Graphic

• 16 types can be specified by ROM data

Graphic 2

• 16 types can be specified by ROM data

1 color type can be changed.

Graphic 3

• 16 types can be specified by ROM data

1 color table type can be changed.

• Box (raised or recessed) color (line units): 1 of 16 colors can be specified.

• Background color (screen units): 1 of 16 colors can be specified.

LC74736PT

(8) Color table (palette)

- Sixteen colors can be selected from a set of 4096 colors (One of which is specified to be transparent.)
- Number of color tables: 4. This allows up to 64 colors to be displayed at the same time.

(9) Wallpaper screen (Graphics glyphs only)

Wallpaper display: Repeated display under the main screen

(up to 4 characters horizontally by 4 characters vertically).

Sprite character display: Displayed above the main screen

(up to 4 characters horizontally by 4 characters vertically).

(10) Line spacing control

0-15 scan lines (in line units)

(11) Output

Analog RGB output(to 20MHz)

Digital RGB output (4 bits per color)

BLK (OSD display period signal)

Package: TQFP100

Voltage: 3.3V

Package Dimensions

unit : mm (typ)

3274

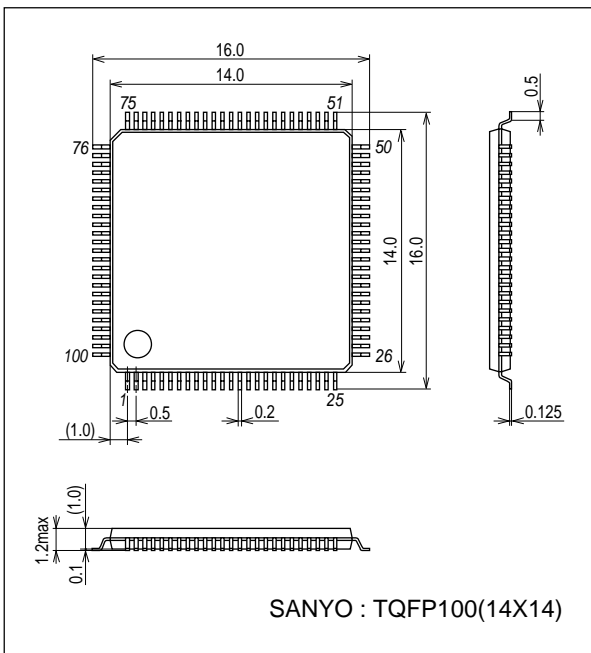

LC74736PT

Pin Assignment

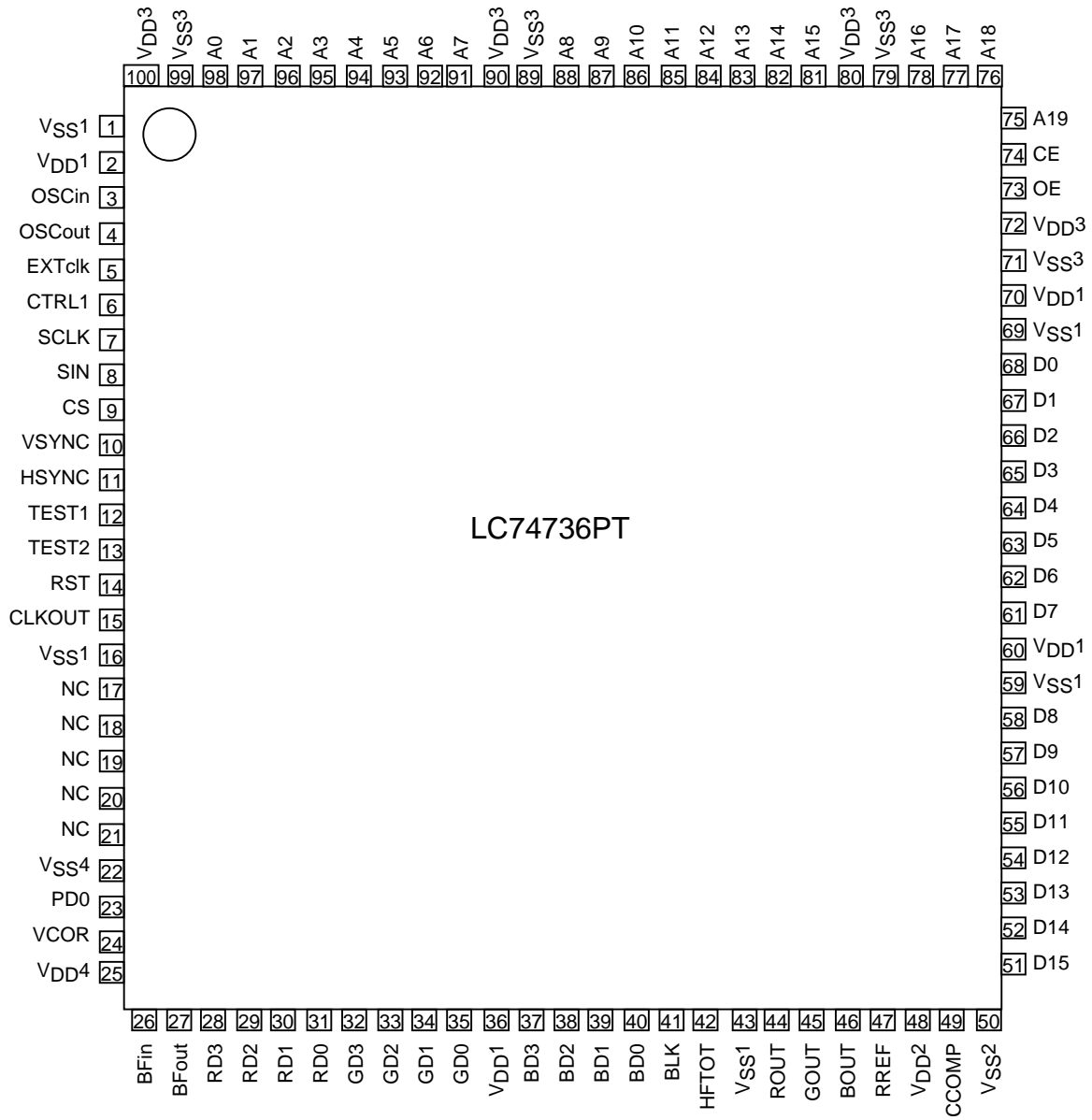

Top view

LC74736PT

Pin Functions

Pin No.	Symbol	Type	Functional description
1	V _{SS1}	Ground	Connect a ground to this pin. (Digital system ground)
2	V _{DD1}	Power supply (+3.3V)	Digital system power supply: +3.3V
3	OSCin	LC oscillator	Connect to the character output dot clock generator oscillator coil and capacitor.
4	OSCOut		
5	EXTclk	External clock signal input	Receives an external clock signal. Capacitor coupling, 50% duty cycle, 0.5Vp-p or higher
6	CTRL1	OSCin oscillator input control	Switches between external clock input mode and LC oscillator mode. Low: LC oscillator, high: external clock input MORE+ OR control with MORE+ command
7	SCLK	Clock input	Clock input for the serial data input system MORE+ (This input has hysteresis characteristics.)
8	SIN	Data input	Serial data input MORE+ (This input has hysteresis characteristics.)
9	\overline{CS}	Enable input	Enable input for the serial data input system. Serial data input is enabled when this pin is set low. MORE+ (This input has hysteresis characteristics.)
10	VSYNC	Vertical sync signal input	Vertical sync signal input MORE+ (This input has hysteresis characteristics.)
11	HSYNC	Horizontal sync signal input	Horizontal sync signal input MORE+ (This input has hysteresis characteristics.)
12	TEST1	Test mode control 1	Test mode control 1 Low: normal operation, high: test mode MORE+
13	TEST2	Test mode control 2	Test mode control 2 Low: normal operation, high: test mode (scan mode) MORE+
14	\overline{RST}	Reset input	System reset input MORE+ (This input has hysteresis characteristics.)
15	CLKOUT	Clock output	Clock output
16	V _{SS1}	Ground	Connect a ground to this pin. (Digital system ground)
17	NC		
18	NC		
19	NC		
20	NC		
21	NC		
22	V _{SS4}	Ground	Connect a ground to this pin. (PLL system power supply)
23	PD0	PLL charge pump output PLL VCO control voltage input	Charge pump output Connect a LPF (lug lead filter) to this pin. Voltage input for internal VCO control
24	VCOR	VCO variable range adjustment	Used to adjust variable voltage range of internal VCO. Connect a resistor to this pin.
25	V _{DD4}	Power supply (+3.3V)	PLL system power supply: +3.3V
26	BFin	Amplifier input	Oscillation input for external VCO
27	BFout	Amplifier output	Oscillation output for external VCO
28	RD3	Rout output: bit 3	Rout output This is a 4-bit digital output with values from 0000 to 1111.
29	RD2	Rout output: bit 2	
30	RD1	Rout output: bit 1	
31	RD0	Rout output: bit 0	
32	GD3	Gout output: bit 3	Gout output This is a 4-bit digital output with values from 0000 to 1111.
33	GD2	Gout output: bit 2	
34	GD1	Gout output: bit 1	
35	GD0	Gout output: bit 0	
36	V _{DD1}	Power supply (+3.3V)	Digital system power supply: +3.3V

Continued on next page.

LC74736PT

Continued from preceding page.

Pin No.	Symbol	Type	Functional description
37	BD3	Bout output: bit 3	Bout output This is a 4-bit digital output with values from 0000 to 1111.
38	BD2	Bout output: bit 2	
39	BD1	Bout output: bit 1	
40	BD0	Bout output: bit 0	
41	BLK	Blanking signal output	This signal indicates the OSD display period.
42	HFTOT	Half-tone control signal output	OSD half-tone period control signal Synthesized in the next stage IC.
43	V _{SS1}	Ground	Connect a ground to this pin. (Digital system ground)
44	Rout	Rout output: analog	D/A converter (4 bits) output. Connect a resistor R _o to this pin.
45	Gout	Gout output: analog	D/A converter (4 bits) output. Connect a resistor R _o to this pin.
46	Bout	Bout output: analog	D/A converter (4 bits) output. Connect a resistor R _o to this pin.
47	RREF	Reference resistor connection	Connect a reference register to this pin.
48	V _{DD2}	Power supply (+3.3V)	D/A converter power supply: +3.3V
49	CCOMP	Phase correction capacitor connection	Capacitor connection: 1.5μF
50	V _{SS2}	Ground	Connect a ground to this pin. (D/A converter ground)
51	D15	Data input 15	ROM data input 15. MORE+ [MSB]
52	D14	Data input 14	ROM data input 14. MORE+
53	D13	Data input 13	ROM data input 13. MORE+
54	D12	Data input 12	ROM data input 12. MORE+
55	D11	Data input 11	ROM data input 11. MORE+ [MSB]
56	D10	Data input 10	ROM data input 10. MORE+
57	D9	Data input 9	ROM data input 9. MORE+
58	D8	Data input 8	ROM data input 8. MORE+
59	V _{SS1}	Ground	Connect a ground to this pin. (Digital system ground)
60	V _{DD1}	Power supply (+3.3V)	Digital system power supply: +3.3V
61	D7	Data input 7	ROM data input 7. MORE+
62	D6	Data input 6	ROM data input 6. MORE+
63	D5	Data input 5	ROM data input 5. MORE+
64	D4	Data input 4	ROM data input 4. MORE+
65	D3	Data input 3	ROM data input 3. MORE+
66	D2	Data input 2	ROM data input 2. MORE+
67	D1	Data input 1	ROM data input 1. MORE+
68	D0	Data input 0	ROM data input 0. MORE+ [LSB][LSB]
69	V _{SS1}	Ground	Connect a ground to this pin. (Digital system ground)
70	V _{DD1}	Power supply (+3.3V)	Power supply: (+3.3V: Digital system)
71	V _{SS3}	Ground	Connect a ground to this pin. (External ROM output system ground)
72	V _{DD3}	Power supply (+3.3 or +5.5V)	Power supply (External ROM output system power supply)
73	\overline{OE}	Output enable	ROM output enable output. This is an active low output.
74	\overline{CE}	Chip enable	ROM chip enable output. This is an active low output.
75	A19	Address output 19	ROM address output 19
76	A18	Address output 18	ROM address output 18
77	A17	Address output 17	ROM address output 17
78	A16	Address output 16	ROM address output 16
79	V _{SS3}	Ground	Connect a ground to this pin. (External ROM output system ground)
80	V _{DD3}	Power supply (+3.3 or +5.5V)	Power supply (External ROM output system power supply)
81	A15	Address output 15	ROM address output 15
82	A14	Address output 14	ROM address output 14
83	A13	Address output 13	ROM address output 13
84	A12	Address output 12	ROM address output 12
85	A11	Address output 11	ROM address output 11

Continued on next page.

LC74736PT

Continued from preceding page.

Pin No.	Symbol	Type	Functional description
86	A10	Address output 10	ROM address output 10
87	A9	Address output 9	ROM address output 9
88	A8	Address output 8	ROM address output 8
89	V _{SS3}	Ground	Connect a ground to this pin. (External ROM output system ground)
90	V _{DD3}	Power supply (+3.3 or +5.5V)	Power supply (External ROM output system power supply)
91	A7	Address output 7	ROM address output 7
92	A6	Address output 6	ROM address output 6
93	A5	Address output 5	ROM address output 5
94	A4	Address output 4	ROM address output 4
95	A3	Address output 3	ROM address output 3
96	A2	Address output 2	ROM address output 2
97	A1	Address output 1	ROM address output 1
98	A0	Address output 0	ROM address output 0
99	V _{SS3}	Ground	Connect a ground to this pin. (External ROM output system ground)
100	V _{DD3}	Power supply (+3.3 or +5.5V)	Power supply (External ROM output system power supply)

Specifications

Absolute Maximum Ratings at T_a=25°C

Parameter	Symbol	Conditions	Ratings	Unit
Supply voltage	V _{DD1}	V _{DD1} , V _{DD2} , and V _{DD4}	V _{SS} -0.3 to V _{SS} +4.6	V
	V _{DD3}	V _{DD3}	V _{SS} -0.3 to V _{SS} +6.0	V
Input voltage	V _{IN}	All input pins	V _{SS} -0.3 to V _{DD1} +0.3	V
Output voltage	V _{OUT1}	RD3 to RD0, GD3 to GD0, BD3 to BD0, BLK, HFTOT outputs	V _{SS} -0.3 to V _{DD1} +0.3	V
	V _{OUT2}	A0 to 19, \overline{CE} , \overline{OE} outputs	V _{SS} -0.3 to V _{DD3} +0.3	V
Maximum power dissipation	P _{d max}		275	mW
Operating temperature	T _{opr}		-40 to +85	°C
Storage temperature	T _{stg}		-40 to +125	°C

Recommended Operating Conditions

Parameter	Symbol	Conditions	Ratings			Unit
			min	typ	max	
Supply voltage	V _{DD1}	V _{DD1} , 2, and V _{DD4}	3.0	3.3	3.6	V
	V _{DD3}	V _{DD3}	3.0	3.3	5.5	V
Input high-level voltage	V _{IH1}	CTRL1, TEST1, TEST2	0.7V _{DD1}		5.5	V
	V _{IH2}	SCLK, SIN, \overline{CS} , VSYNC, HSYNC, \overline{RST}	0.8V _{DD1}		5.5	V
	V _{IH3}	D0 to D15	0.7V _{DD1}		5.5	V
Input low-level voltage	V _{IL1}	CTRL1, TEST1, TEST2	V _{SS} -0.3		0.3V _{DD1}	V
	V _{IL2}	SCLK, SIN, \overline{CS} , VSYNC, HSYNC, \overline{RST}	V _{SS} -0.3		0.2V _{DD1}	V
	V _{IL3}	D0 to D11	V _{SS} -0.3		0.3V _{DD1}	V
Oscillator frequency (LC)	FOSC1	OSCin and OSCout oscillator pins (LC oscillator)		10		MHz
External clock input	FOSC2	OSCin, V _{DD1} = 3.3V		33	40	MHz
	V _{IN1}	V _{DD1} = 3.3V CTRL1 = high	0.5		3.3	Vp-p
Oscillator frequency (VCO)	FOSC3	VCO oscillator (internal)	7		40	MHz
D/A converter (4-bit, 3 ch) When maximum output voltage = 0.7V	Vrefda	Reference voltage		1.1		V
	Rfda	Output load resistance ROUT, GOUT, BOUT	120		225	Ω
	Rref	Reference load resistance, RREF		1100		Ω

LC74736PT

Electrical Characteristics at Ta = -40 to +85°C, V_{DD} = 3.3V unless otherwise specified

Parameter	Symbol	Pin	Conditions	Ratings			Unit
				min	typ	max	
Output high-level voltage	V _{OH1}	RD3 to RD0, GD3 to GD0, BD3 to BD0, BLK, and HFTOT outputs	V _{DD1} = 3.0V I _{OH1} = -8mA	V _{DD1} -0.8			V
	V _{OH2}	A0 to A19, \overline{CE} , and \overline{OE}	V _{DD3} = 3.0V I _{OH2} = -8mA	V _{DD3} -0.8			V
	V _{OH3}	A0 to A19, \overline{CE} , and \overline{OE}	V _{DD3} = 4.5V I _{OH3} = -8mA	V _{DD3} -0.8			V
Output low-level voltage	V _{OL1}	RD3 to RD0, GD3 to GD0, BD3 to BD0, BLK, and HFTOT outputs	V _{DD1} = 3.0V I _{OL1} = 8mA			0.4	V
	V _{OL2}	A0 to A19, \overline{CE} , and \overline{OE}	V _{DD3} = 3.0V I _{OL2} = 8mA			0.4	V
	V _{OL3}	A0 to A19, \overline{CE} , and \overline{OE}	V _{DD3} = 4.5V I _{OL3} = 8mA			0.4	V
Input current	I _{IH1}	CTRL1, TEST1, TEST2 SCLK, SIN, \overline{CS} , VSYNC, HSYNC, \overline{RST}	V _{IN} = V _{DD1}			10	μA
	I _{IH2}	D0 to D15	V _{IN} = V _{DD3}			10	μA
	I _{IL1}	CTRL1, TEST1, TEST2 SCLK, SIN, \overline{CS} , VSYNC, HSYNC	V _{IN} = V _{SS}	-10			μA
	I _{IL2}	D0 to D15	V _{IN} = V _{SS}	-10			μA
Operating current drain	I _{DD1}	V _{DD1}	All outputs open OSCin: 20MHz			25	mA
	I _{DD2}	V _{DD2}	D/A on			22	mA
	I _{DD3}	V _{DD3}				10	mA
	I _{DD4}	V _{DD4}	VCO on			22	mA
D/A converter	CLK	Clock frequency				20	MHz
	V max	Maximum output voltage	V _{DD2} = 3.3V	0.25		1.5	V
	V min0	Minimum output voltage	V _{DD2} = 3.3V		0		V

Timing Characteristics

OSD Write (See figure 1.) at Ta = -40 to +85°C, V_{DD1} = 3.3V ± 0.3V

Parameter	Symbol	Conditions	Ratings			Unit
			min	typ	max	
Minimum input pulse width	t _w (sclk)	SCLK	200			ns
	t _w (cs)	\overline{CS} (The period \overline{CS} is high)	1			μs
Data setup time	t _{su} (cs)	\overline{CS}	200			ns
	t _{su} (sin)	SIN	200			ns
Data hold time	t _h (cs)	\overline{CS}	2			μs
	t _h (sin)	SIN	200			ns
One word write time	t _{word}	The time to write 8 bits of data	4.2			μs
	t _{wt}	RAM data write time	1			μs

Supplementary Materials

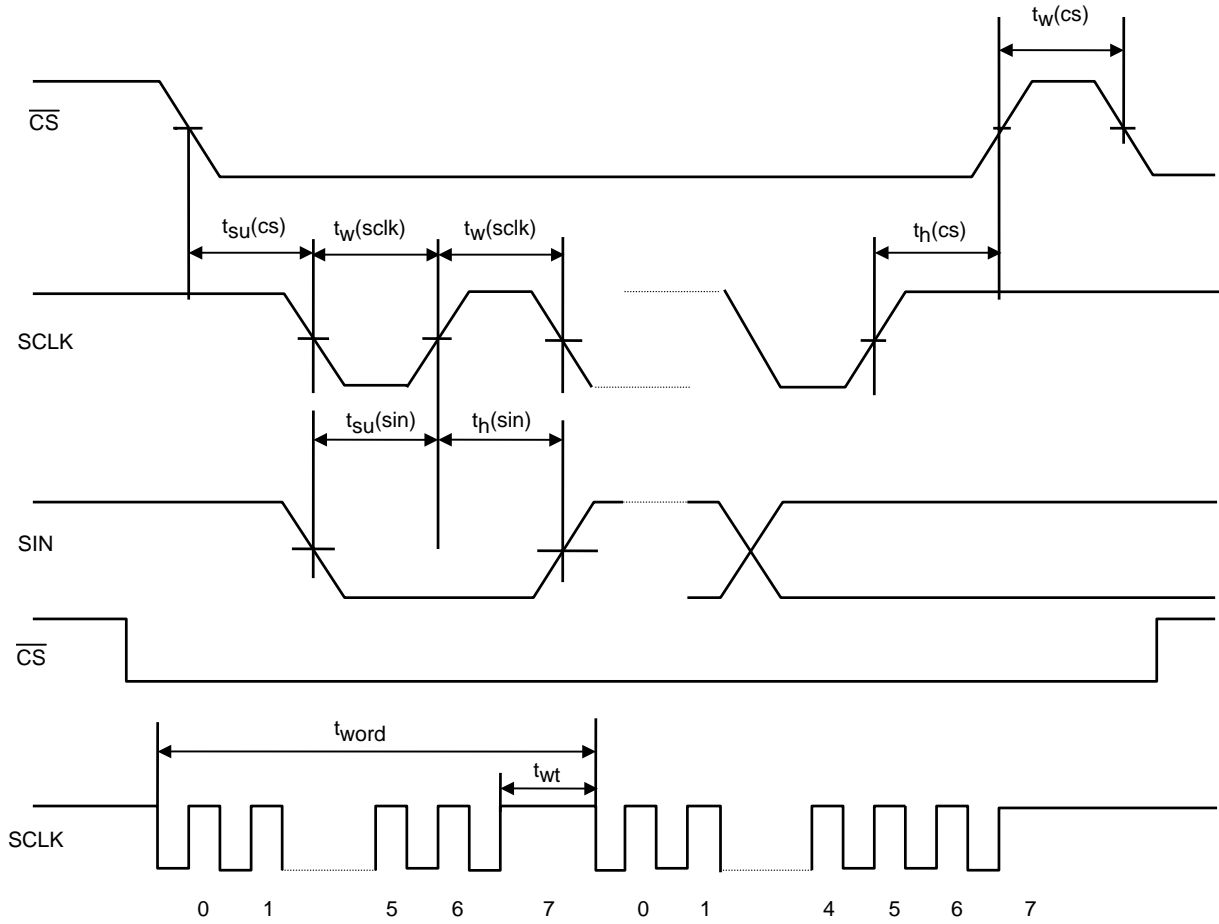
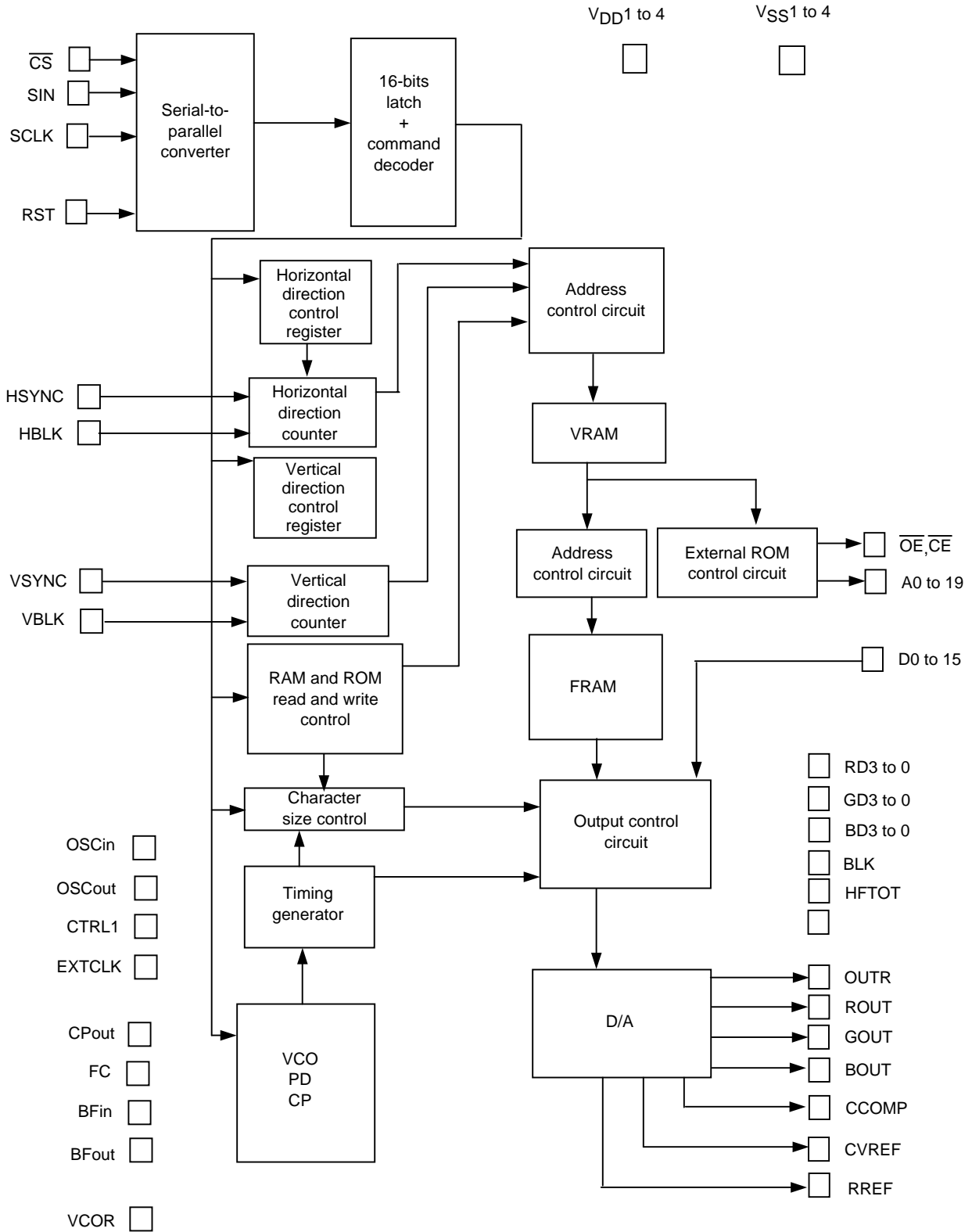

Figure 1 OSD Serial Data Input Timing

System Block Diagram



LC74736PT

Display Control Commands

The display control commands have serial input format that consists of 8-bit units transmitted LSB first. A command consists of a command identification code in the first byte and data in the second and following bytes. Both a first byte and a second byte (16 bits) must be transmitted for each command. Commands 10, 11, 12, 6C1, and 701 set the IC to continuous write mode. (Continuous write mode is cleared by setting the CS pin high.)

Display Control Command Table

Command	First byte								Second byte							
	Command identification code data								Data							
	7	6	5	4	3	2	1	0	7	6	5	4	3	2	1	0
COMMAND00 (Write address) Main 1: V	1	0	0	0	0	0	0	0	0	0	0	V14	V13	V12	V11	V10
COMMAND01 (Write address) Main 1: H	1	0	0	0	0	0	1	0	0	0	H15	H14	H13	H12	H11	H10
COMMAND02 (Write address) Main 2: V	1	0	0	0	0	1	0	0	0	0	0	V24	V23	V22	V21	V20
COMMAND03 (Write address) Main 2: H	1	0	0	0	0	1	1	0	0	0	H25	H24	H23	H22	H21	H20
COMMAND04 (Write address) Sub	1	0	0	0	1	0	0	0	SV1	SV0	0	0	0	0	SH1	SH0
COMMAND10 (Character write) Main 1	1	0	0	1	0	0	RM2 RM1[1]		HF1	HF0	at	BXS	BXL	BXR	BXU	BXD
							[2]		CB3	CB2	CB1	CB0	CC3	CC2	CC1	CC0
							[3]		0	CTB1	CTB0	I/E	MG1	MG0	RO1	RO0
							[4]		0	0	C13	C12	C11	C10	C9	C8
							[5]		C7	C6	C5	C4	C3	C2	C1	C0
COMMAND11 (Character write) Main 2	1	0	0	1	0	1	RM2 RM1[1]		HF1	HF0	at	BXS	BXL	BXR	BXU	BXD
							[2]		CB3	CB2	CB1	CB0	CC3	CC2	CC1	CC0
							[3]		0	CTB1	CTB0	I/E	MG1	MG0	RO1	RO0
							[4]		0	0	C13	C12	C11	C10	C9	C8
							[5]		C7	C6	C5	C4	C3	C2	C1	C0
COMMAND12 (Character write) Sub	1	0	0	1	1	0	RM2 RM1[1]		0	0	0	0	0	0	0	0
							[2]		0	0	0	0	0	0	0	0
							[3]		0	CTB1	CTB0	I/E	MG1	MG0	RO1	RO0
							[4]		0	0	C13	C12	C11	C10	C9	C8
							[5]		C7	C6	C5	C4	C3	C2	C1	C0
COMMAND20 (System control)	1	0	1	0	0	0	0	0	TST	TST	SYS	FRM	CT	SRM	MRM	MRM
COMMAND21 (Display control)	1	0	1	0	0	0	0	1	BK	BK	BK	BK	DSP	DSP	DSP	DSP
COMMAND22 (I/O polarity control 1)	1	0	1	0	0	0	1	0	12	02	11	01	BG	GS	GM2	GM1
COMMAND23 (Screen background color)	1	0	1	0	0	0	1	1	0	BLOP	BLO	BLO	BLO	CKP	VIP	HIP
COMMAND24 (I/O polarity control 2)	1	0	1	0	0	1	0	0	2	1	0					
									DPM	DPM	BGC	BGC	BGC	BGC	BGC	BGC
									HC1	HC0	T1	T0	3	2	1	0
									DPM	DPM	DA	SBG	GD	GD	GD	CKOP
									MD	VC	SEL	SL	2	1	0	

Continued on next page.

LC74736PT

Continued from preceding page.

Command	First byte								Second byte							
	Command identification code data								Data							
	7	6	5	4	3	2	1	0	7	6	5	4	3	2	1	0
COMMAND25 (Output control 1)	1	0	1	0	0	1	0	1	CEH	TOK	VI	LCS	OTM	OTM	LCS	LCS
								SL	SL	PSL	SP2	1	0	STP	OFF	
COMMAND26 (Output control 2)	1	0	1	0	0	1	1	0	HF	TBL	KBL	BL	BL	OTM	ROT	DOT
								OFF	OFF	2	1	0	2	OFF	OFF	
COMMAND27 (Output control 3)	1	0	1	0	0	1	1	1	0	HFT	HFT	HFT	TOK	TOK	TOK	TOK
								2	1	0	CB4	CB3	CB2	CB1		
COMMAND28 (Output control 4)	1	0	1	0	1	0	0	0	HPG	HPS	HPM	HPM	VPG	VPS	VPM	VPM
								9	9	29	19	8	8	28	18	
COMMAND29 (Output control 5)	1	0	1	0	1	0	0	1	0	SVH	SVH	SHH	SHH	0	0	ML
								1	0	1	0				CH	
COMMAND2A (Display area control 1)	1	0	1	0	1	0	1	0	0	HIN	HI	HI	VI	VI	0	0
								DIN	D1	D0	D1	D0				
COMMAND30 (Vertical display start position: main 1)	1	0	1	1	0	0	0	0	VPM	VPM	VPM	VPM	VPM	VPM	VPM	VPM
								17	16	15	14	1	12	11	10	
COMMAND31 (Horizontal display start position: main 1)	1	0	1	1	0	0	1	HPM	HPM	HPM	HPM	HPM	HPM	HPM	HPM	HPM
								18	17	16	15	14	13	12	11	10
COMMAND32 (Vertical display start position: main 2)	1	0	1	1	0	1	0	0	VPM	VPM	VPM	VPM	VPM	VPM	VPM	VPM
								27	26	25	24	23	22	21	20	
COMMAND33 (Horizontal display start position: main 2)	1	0	1	1	0	1	1	HPM	HPM	HPM	HPM	HPM	HPM	HPM	HPM	HPM
								28	27	26	25	24	23	22	21	20
COMMAND34 (Vertical display start positions: sub)	1	0	1	1	1	0	0	0	VPS	VPS	VPS	VPS	VPS	VPS	VPS	VPS
								7	6	5	4	3	2	1	0	
COMMAND35 (Horizontal display start position: sub)	1	0	1	1	1	0	1	HPS	HPS	HPS	HPS	HPS	HPS	HPS	HPS	HPS
								8	7	6	5	4	3	2	1	0
COMMAND36 (Vertical display start positions: screen)	1	0	1	1	1	1	0	0	VPG	VPG	VPG	VPG	VPG	VPG	VPG	VPG
								7	6	5	4	3	2	1	0	
COMMAND37 (Horizontal display start position: screen)	1	0	1	1	1	1	1	HPG	HPG	HPG	HPG	HPG	HPG	HPG	HPG	HPG
								8	7	6	5	4	3	2	1	0

Continued on next page.

LC74736PT

Continued from preceding page.

Command	First byte								Second byte							
	Command identification code data								Data							
	7	6	5	4	3	2	1	0	7	6	5	4	3	2	1	0
COMMAND40 (Character size control)	1	1	0	0	0	0	0	0	0	0	0	0	SZV1	SZV0	SZH1	SZH0
COMMAND41 main 1 (Character size control: line setting U)	1	1	0	0	0	0	0	1	LSZ	LSZ	LSZ	LSZ	LSZ	LSZ	LSZ	LSZ
COMMAND42 main 1 (Character size control: line setting D)	1	1	0	0	0	0	1	0	LSZ	LSZ	LSZ	LSZ	LSZ	LSZ	LSZ	LSZ
COMMAND43 main 1 (Character size control: line setting D2)	1	1	0	0	0	0	1	1	0	0	0	0	0	0	LSZ	LSZ
COMMAND44 main 2 (Character size control: line setting U)	1	1	0	0	0	1	0	0	LSZ	LSZ	LSZ	LSZ	LSZ	LSZ	LSZ	LSZ
COMMAND45 main 2 (Character size control: line setting D)	1	1	0	0	0	1	0	1	LSZ	LSZ	LSZ	LSZ	LSZ	LSZ	LSZ	LSZ
COMMAND46 main 2 (Character size control: line setting D2)	1	1	0	0	0	1	1	0	0	0	0	0	0	0	LSZ	LSZ
COMMAND50 (BOX control U)	1	1	0	1	0	0	0	0	BXL	BXL	BXU	BXU	BXU	BXU	BXU	BXU
COMMAND51 (BOX control D)	1	1	0	1	0	0	0	1	W1	W0	CT1	CT0	C3	C2	C1	C0
COMMAND52 main 1 (BOX control: line setting U)	1	1	0	1	0	0	1	0	BXR	BXR	BXD	BXD	BXD	BXD	BXD	BXD
COMMAND53 main 1 (BOX control: line setting D)	1	1	0	1	0	0	1	1	W1	W0	CT1	CT0	C3	C2	C1	C0
COMMAND54 main 1 (BOX control: line setting D2)	1	1	0	1	0	1	0	0	LBX	LBX	LBX	LBX	LBX	LBX	LBX	LBX
COMMAND55 main 2 (BOX control: line setting U)	1	1	0	1	0	0	1	1	7	6	5	4	3	2	1	0
COMMAND56 main 2 (BOX control: line setting D)	1	1	0	1	0	1	1	0	15	14	13	12	11	10	9	8
COMMAND57 main 2 (BOX control: line setting D2)	1	1	0	1	0	1	1	1	0	0	0	0	0	0	LBX	LBX
															17	16

Continued on next page.

LC74736PT

Continued from preceding page.

Command	First byte								Second byte							
	Command identification code data								Data							
	7	6	5	4	3	2	1	0	7	6	5	4	3	2	1	0
COMMAND58 (Line spacing control 1)	1	1	0	1	1	0	0	0	0	GYB CK	GS 1	GS 0	GY 3	GY 2	GY 1	GY 0
COMMAND59 (Line spacing control 2)	1	1	0	1	1	0	0	1	BXD W	BXU W	GYH SL	BXH SL	FCH SL	BXC 3	BXC 2	BXC 1
COMMAND5A main 1 (Line spacing control: line setting U)	1	1	0	1	1	0	1	0	LGY 7	LGY 6	LGY 5	LGY 4	LGY 3	LGY 2	LGY 1	LGY 0
COMMAND5B main 1 (Line spacing control: line setting U)	1	1	0	1	1	0	1	1	LGY 15	LGY 14	LGY 13	LGY 12	LGY 11	LGY 10	LGY 9	LGY 8
COMMAND5C main 1 (Line spacing control: line setting D2)	1	1	0	1	1	1	0	0	0	0	0	0	0	0	LGY 17	LGY 16
COMMAND5D main 2 (Line spacing control: line setting U)	1	1	0	1	1	1	0	1	LGY 7	LGY 6	LGY 5	LGY 4	LGY 3	LGY 2	LGY 1	LGY 0
COMMAND5E main 2 (Line spacing control: line setting D)	1	1	0	1	1	1	1	0	LGY 15	LGY 14	LGY 13	LGY 12	LGY 11	LGY 10	LGY 9	LGY 8
COMMAND5F main 2 (Line spacing control: line setting D2)	1	1	0	1	1	1	1	1	0	0	0	0	0	0	LGY 17	LGY 16
COMMAND60 (Border control)	1	1	1	0	0	0	0	0	BLK T1	BLK T0	EGC 3	EGC 2	EGC 1	EGC 0	EGC 0	EGC 0
COMMAND61 main 1 (Border control: line setting U)	1	1	1	0	0	0	0	1	LFC 7	LFC 6	LFC 5	LFC 4	LFC 3	LFC 2	LFC 1	LFC 0
COMMAND62 main 1 (Border control: line setting D)	1	1	1	0	0	0	1	0	LFC 15	LFC 14	LFC 13	LFC 12	LFC 11	LFC 10	LFC 9	LFC 8
COMMAND63 main 1 (Border control: line setting D2)	1	1	1	0	0	0	1	1	0	0	0	0	0	0	LFC 17	LFC 16
COMMAND64 main 2 (Border control: line setting U)	1	1	1	0	0	1	0	0	LFC 7	LFC 6	LFC 5	LFC 4	LFC 3	LFC 2	LFC 1	LFC 0
COMMAND65 main 2 (Border control: line setting D)	1	1	1	0	0	1	0	1	LFC 15	LFC 14	LFC 13	LFC 12	LFC 11	LFC 10	LFC 9	LFC 8
COMMAND66 main 2 (Border control: line setting D2)	1	1	1	0	0	1	1	0	0	0	0	0	0	0	LFC 17	LFC 16
COMMAND67 (PLL control 1)	1	1	1	0	0	1	1	1	EVO OFF	LC OFF	ECK OFF	VCO OFF	VCS 1	VCS 0	CKSL 1	CKSL 0
COMMAND68 (PLL control 2)	1	1	1	0	1	0	0	0	0	0	0	DIV 12	DIV 11	DIV 10	DIV 9	DIV 8
COMMAND69 (PLL control 3)	1	1	1	0	1	0	0	1	DIV 7	DIV 6	DIV 5	DIV 4	DIV 3	DIV 2	DIV 1	DIV 0
COMMAND6A (PLL control 5)	1	1	1	0	1	0	1	0	0	HD SL	DZ 1	DZ 0	HR SL	DID 2	DID 1	DID 0
COMMAND6C0 (Write address) Color table	1	1	1	0	1	1	0	0	0	0	CTN 1	CTN 0	CTA 3	CTA 2	CTA 1	CTA 0
COMMAND6C1 (Data write) Color table	1	1	1	0	1	1	1	RM3[1] [2]	0	0	HFT TG3	TOK TG2	TB3 TG1	TB2 TG0	TB1 TR3	TB0 TR2

Continued on next page.

LC74736PT

Continued from preceding page.

Command	First byte								Second byte								
	Command identification code data								Data								
	7	6	5	4	3	2	1	0	7	6	5	4	3	2	1	0	
COMMAND700 (character ram1) writeaddress	1	1	1	1	0	0	0	0	FAD	FAD	FRN	FRN	FVA	FVA	FVA	FVA	
									1	0	1	0	3	2	1	0	
COMMAND701 (character ram2) write	1	1	1	1	0	0	1	RM3[1]	D15	D14	D13	D12	D11	D10	D9	D8	
								[2]	D7	D6	D5	D4	D3	D2	D1	D0	
COMMAND710 (WVGA ROM)	1	1	1	1	0	1	0	0	0	0	CKO	CKO	WFC	WRA	WRA	WRA	
											S1	S0	MD	M2	M1	M0	
COMMAND711 (PLL control 6)	1	1	1	1	0	1	0	1	RSTB	0	VCRS	VCRS	CP	0	CP	CP	
													1	0	X2	I11	I0
COMMAND712 (PLL control 7)	1	1	1	1	0	1	1	0	0	STB	RES	SCP	DIV	GAN	GAN	GAN	
										CP	CP	CP	ECP	2	1	0	

1 COMMAND00 (Main screen 1: horizontal write address setting command)

(1) First byte

DA0 to 7	Register	Content		Notes
		State	Function	
7	-	1	Command 0 identification code	
6	-	0	Main screen 1 memory horizontal write address setting	
5	-	0		
4	-	0		
3	-	0	Sub-identification code: 0	
2	-	0		
1	-	0		
0	-	0		

(2) Second byte

DA0 to 7	Register	Content		Notes
		State	Function	
7	-	0		COM24-2: Line number specification
6	-	0		
5	-	0		
4	V14 [MSB]	0	Main screen 1 memory line address (0 to 11, hexadecimal) 15 lines: 0E (hexadecimal) 18 lines: 11 (hexadecimal)	
		1		
3	V13	0		
		1		
2	V12	0		
		1		
1	V11	0		
		1		
0	V10 [LSB]	0		
		1		

*: This resistor is set to the all bits zero state when the IC is reset by the \overline{RST} pin.

LC74736PT

2 COMMAND01 (Main screen 1: vertical write address setting command)

(1) First byte

DA0 to 7	Register	Content		Notes
		State	Function	
7	-	1	Command 0 identification code	
6	-	0	Main screen 1 memory vertical write address setting	
5	-	0		
4	-	0		
3	-	0	Sub-identification code: 1	
2	-	0		
1	-	1		
0	-	0		

(2) Second byte

DA0 to 7	Register	Content		Notes
		State	Function	
7	-	0		
6	-	0		
5	-	0		
4	H15 [MSB]	0	Main screen 1 memory character position address (0 to 21, hexadecimal) 30 characters: 1D (hexadecimal) 33 characters: 20 (hexadecimal) 34 characters: 21 (hexadecimal)	COM23-2: Character number specification
		1		
4	H14	0		
		1		
3	H13	0		
		1		
2	H12	0		
		1		
1	H11	0		
		1		
0	H10 [LSB]	0		
		1		

*: This resistor is set to the all bits zero state when the IC is reset by the $\overline{\text{RST}}$ pin.

LC74736PT

3 COMMAND02 (Main screen 2: horizontal write address setting command)

(1) First byte

DA0 to 7	Register	Content		Notes
		State	Function	
7	-	1	Command 0 identification code	
6	-	0	Main screen 2 memory horizontal write address setting	
5	-	0		
4	-	0		
3	-	0	Sub-identification code: 2	
2	-	1		
1	-	0		
0	-	0		

(2) Second byte

DA0 to 7	Register	Content		Notes
		State	Function	
7	-	0		
6	-	0		
5	-	0		
4	V24 [MSB]	0	Main screen 2 memory line address (0 to 0E, hexadecimal) 15 lines: 0E (hexadecimal) 18 lines: 11 (hexadecimal)	COM24-2: Line number specification
		1		
3	V23	0		
		1		
2	V22	0		
		1		
1	V21	0		
		1		
0	V20 [LSB]	0		
		1		

*: This resistor is set to the all bits zero state when the IC is reset by the $\overline{\text{RST}}$ pin.

LC74736PT

4 COMMAND03 (Main screen 2: vertical write address setting command)

(1) First byte

DA0 to 7	Register	Content		Notes
		State	Function	
7	-	1	Command 0 identification code	
6	-	0	Main screen 2 memory vertical write address setting	
5	-	0		
4	-	0		
3	-	0	Sub-identification code: 3	
2	-	1		
1	-	1		
0	-	0		

(2) Second byte

DA0 to 7	Register	Content		Notes
		State	Function	
7	-	0		
6	-	0		
5	-	0		
4	H25 [MSB]	0	Main screen 2 memory character position address (0 to 21, hexadecimal) 30 characters: 1D (hexadecimal) 33 characters: 20 (hexadecimal) 34 characters: 21 (hexadecimal)	COM23-3: Character number specification
		1		
4	H24	0		
		1		
3	H23	0		
		1		
2	H22	0		
		1		
1	H21	0		
		1		
0	H20 [LSB]	0		
		1		

*: This resistor is set to the all bits zero state when the IC is reset by the $\overline{\text{RST}}$ pin.

LC74736PT

5 COMMAND04 (Subscreen write address setting command)

(1) First byte

DA0 to 7	Register	Content		Notes
		State	Function	
7	-	1	Command 0 identification code Subscreen write address setting	
6	-	0		
5	-	0		
4	-	0		
3	-	1	Sub-identification code: 4	
2	-	0		
1	-	0		
0	-	0		

(2) Second byte

DA0 to 7	Register	Content		Notes
		State	Function	
7	SV1	0	Subscreen memory line address 0 to 3 (hexadecimal) 4 lines (maximum)	COM29-2: Line number specification
		1		
6	SV0	0		
		1		
5	-	0		
4	-	0		
3	-	0		
2	-	0		
1	SH1	0	Subscreen memory character position address 0 to 3 (hexadecimal) 4 characters (maximum)	COM29-2: Character number specification
		1		
0	SH0	0		
		1		

*: This resistor is set to the all bits zero state when the IC is reset by the \overline{RST} pin.

LC74736PT

6 COMMAND10 (Main screen 1 display character data write setting command)

(1) First byte

DA0 to 7	Register	Content		Notes
		State	Function	
7	-	1	Command 1 identification code	When this command has been issued, the IC remains in display character data write mode until the \overline{CS} pin is set high.
6	-	0	Display character data write setting	
5	-	0		
4	-	1		
3	-	0	Sub-identification code: 0	
2	-	0		
1	RM2	0	RM2 RM1 Mode	Continuous write mode selection
		1	0 0 [1][2][3][4][5] End	
0	RM1	0	0 1 [1][2][3][4][5] Continuous	
		1	1 0 [3][4][5] Continuous	
		1	1 1 [2][3][4][5] Continuous	

(2) Second byte-[1]

DA0 to 7	Register	Content		Notes
		State	Function	
7	HFT1	0	HFT1 HFT0	Halftone specification Graphic is processed as a character. COM59-2
		1	0 0 None	
6	HFT0	0	0 1 Character only	
		1	1 0 Character background only	
		1	1 1 Character+Character background	
5	at	0	Blinking off	Blinking specification
		1	Blinking on	
4	BXS	0	Raised	Box specification: raised/recessed
		1	Recessed	
3	BXL	0	None	Box specification: left side
		1	Box displayed	
2	BXR	0	None	Box specification: right side
		1	Box displayed	
1	BXU	0	None	Box specification: upper
		1	Box displayed	
0	BXD	0	None	Box specification: down
		1	Box displayed	

*: This resistor is set to the all bits zero state when the IC is reset by the \overline{RST} pin.

LC74736PT

(3) Second byte-[2]

DA0 to 7	Register	Content		Notes
		State	Function	
7	CB3 [MSB]	0	Character background color specification 0000 to 1111, or 0 to F (hexadecimal)	Character background color specification When a character glyph is specified, 1 of 16 colors may be selected.
		1		
6	CB2	0		
		1		
5	CB1	0		
		1		
4	CB0 [LSB]	0		
		1		
3	CC3 [MSB]	0	Character color specification 0000 to 1111, or 0 to F (hexadecimal)	Character color specification When a character glyph is specified, 1 of 16 colors may be selected.
		1		
2	CC2	0		
		1		
1	CC1	0		
		1		
0	CC0 [LSB]	0		
		1		

(4) Second byte-[3]

DA0 to 7	Register	Content		Notes		
		State	Function			
7	-	0				
6	CTB1	0	CTB1 CTB0 0 0 Color table number 1 0 1 Color table number 2 1 0 Color table number 3 1 1 Color table number 4	Color table selection		
		1				
5	CTB0	0				
		1				
4	I/E	0			Character RAM (internal)	ROM selection
		1			External ROM	
3	M/G1	0			MG1 MG0 0 0 Character 0 1 Graphic 1(CB, CC invalid) 1 0 Graphic 2 CTB address shown with CB → Chantged to CTB address shown with CC 1 1 Graphic 3 CTBNo of address shown with CB → Changed to CTBNo shown with CC1, CC0	Character/graphic specification
		1				
2	M/G0	0				
		1				
		1				
1	ROM1	0	ROM1 ROM0 0 0 ROM area number 1 0 1 ROM area number 2 1 0 ROM area number 3 1 1 ROM area number 4	ROM area selection		
		1				
0	ROM0	0				
		1				

*: This resistor is set to the all bits zero state when the IC is reset by the RST pin.

LC74736PT

(5) Second byte-[4]

DA0 to 7	Register	Content		Notes
		State	Function	
7	-	0		
6	-	0		
5	C13 [MSB]	0		Character code specification
		1		
4	C12	0		
		1		
3	C11	0		
		1		
2	C10	0		
		1		
1	C9	0		
		1		
0	C8	0		
		1		

(6) Second byte-[5]

DA0 to 7	Register	Content		Notes
		State	Function	
7	C7	0	Character code External ROM: 16384 characters 0000 to 3FFF (hexadecimal) 0 to 16383 Character RAM (internal): QVGA mode: 0 to 3, hexadecimal, 4 characters WVGA mode: 0 hexadecimal, 1 character * Transparent character specification I/E = 0 (Internal character RAM) M/G10 = 00 (Character) Code = FF (hexadecimal)	Character code specification
		1		
6	C6	0		
		1		
5	C5	0		
		1		
4	C4	0		
		1		
3	C3	0		
		1		
2	C2	0		
		1		
1	C1	0		
		1		
0	C0 [LSB]	0		
		1		

*: This resistor is set to the all bits zero state when the IC is reset by the $\overline{\text{RST}}$ pin.

LC74736PT

7 COMMAND11 (Main screen 2 display character data write setting command)

(1) First byte

DA0 to 7	Register	Content		Notes
		State	Function	
7	-	1	Command 1 identification code	When this command has been issued, the IC remains in display character data write mode until the \overline{CS} pin is set high.
6	-	0	Display character data write setting	
5	-	0		
4	-	1		
3	-	0	Sub-identification code: 1	
2	-	0		
1	RM2	0	RM2 RM1 Mode	Continuous write mode selection
		1	0 0 [1][2][3][4][5] End	
0	RM1	0	0 1 [1][2][3][4][5] Continuous	
		1	1 0 [3][4][5] Continuous	
		1	1 1 [2][3][4][5] Continuous	

(2) Second byte-[1]

DA0 to 7	Register	Content		Notes
		State	Function	
7	HFT1	0	HFT1 HFT0	Halftone specification Graphic is processed as a character. COM59-2
		1	0 0 None	
6	HFT0	0	0 1 Character only	
		1	1 0 Character background only	
		1	1 1 Character+Character background	
5	at	0	Blinking off	Blinking specification
		1	Blinking on	
4	BXS	0	Raised	Box specification: raised/recessed
		1	Recessed	
3	BXL	0	None	Box specification: left side
		1	Box displayed	
2	BXR	0	None	Box specification: right side
		1	Box displayed	
1	BXU	0	None	Box specification: upper
		1	Box displayed	
0	BXD	0	None	Box specification: down
		1	Box displayed	

*: This resistor is set to the all bits zero state when the IC is reset by the \overline{RST} pin.

LC74736PT

(3) Second byte-[2]

DA0 to 7	Register	Content		Notes
		State	Function	
7	CB3 [MSB]	0	Character background color specification 0000 to 1111, or 0 to F (hexadecimal)	Character background color specification When a character glyph is specified, 1 of 16 colors may be selected.
		1		
6	CB2	0		
		1		
5	CB1	0		
		1		
4	CB0 [LSB]	0		
		1		
3	CC3 [MSB]	0	Character color specification 0000 to 1111, or 0 to F (hexadecimal)	Character color specification When a character glyph is specified, 1 of 16 colors may be selected.
		1		
2	CC2	0		
		1		
1	CC1	0		
		1		
0	CC0 [LSB]	0		
		1		

(4) Second byte-[3]

DA0 to 7	Register	Content		Notes		
		State	Function			
7	-	0				
6	CTB1	0	CTB1 CTB0 0 0 Color table number 1 0 1 Color table number 2 1 0 Color table number 3 1 1 Color table number 4	Color table selection		
		1				
5	CTB0	0				
		1				
4	I/E	0			Character RAM (internal)	ROM selection
		1			External ROM	
3	M/G1	0			MG1 MG0 0 0 Character 0 1 Graphic 1 (CB, CC invalid) 1 0 Graphic 2 CTB address shown with CB → Changed to CTB address shown with CC. 1 1 Graphic 3 CTBNo of address shown with CB. → Changed to CTBNo shown with CC1, CC0.	Character/graphic specification
		1				
2	M/G0	0				
		1				
		1				
1	ROM1	0	ROM1 ROM0 0 0 ROM area number 1 0 1 ROM area number 2 1 0 ROM area number 3 1 1 ROM area number 4	ROM area selection		
		1				
0	ROM0	0				
		1				

*: This resistor is set to the all bits zero state when the IC is reset by the RST pin.

LC74736PT

(5) Second byte-[4]

DA0 to 7	Register	Content		Notes
		State	Function	
7	-	0		
6	-	0		
5	C13 [MSB]	0		Character code specification
		1		
4	C12	0		
		1		
3	C11	0		
		1		
2	C10	0		
		1		
1	C9	0		
		1		
0	C8	0		
		1		

(6) Second byte-[5]

DA0 to 7	Register	Content		Notes
		State	Function	
7	C7	0	Character code External ROM: 16384 characters 0000 to 3FFF (hexadecimal) 0 to 16383 Character RAM (internal): QVGA mode: 0 to 3, hexadecimal, 4 characters WVGA mode: 0 hexadecimal, 1 character * Transparent character specification I/E = 0 (Internal character RAM) M/G10 = 00 (Character) Code = FF (hexadecimal)	Character code specification
		1		
6	C6	0		
		1		
5	C5	0		
		1		
4	C4	0		
		1		
3	C3	0		
		1		
2	C2	0		
		1		
1	C1	0		
		1		
0	C0 [LSB]	0		
		1		

*: This resistor is set to the all bits zero state when the IC is reset by the $\overline{\text{RST}}$ pin.

LC74736PT

12 COMMAND12 (Subscreen display character data write setting command)

(1) First byte

DA0 to 7	Register	Content		Notes
		State	Function	
7	-	1	Command 1 identification code Display character data write setting	When this command has been issued, the IC remains in display character data write mode until the \overline{CS} pin is set high.
6	-	0		
5	-	0		
4	-	1		
3	-	1	Sub-identification code 2	
2	-	0		
1	RM2	0	RM2 RM1 Mode	Continuous write mode selection
		1	0 0 [1][2][3][4][5] End	
0	RM1	0	0 1 [1][2][3][4][5] Continuous	
		1	1 0 [3][4][5] Continuous	
		1	1 1 [2][3][4][5] Continuous	

(2) Second byte-[1]

DA0 to 7	Register	Content		Notes
		State	Function	
7	-	0		
6	-	0		
5	-	0		
4	-	0		
3	-	0		
2	-	0		
1	-	0		
0	-	0		

(3) Second byte-[2]

DA0 to 7	Register	Content		Notes
		State	Function	
7	-	0		
6	-	0		
5	-	0		
4	-	0		
3	-	0		
2	-	0		
1	-	0		
0	-	0		

*: This resistor is set to the all bits zero state when the IC is reset by the \overline{RST} pin.

LC74736PT

(4) Second byte-[3]

DA0 to 7	Register	Content		Notes	
		State	Function		
7	-	0			
6	CTB1	0	CTB1 CTB0	Color table selection	
		1	0 0 Color table number 1		
5	CTB0	0	0 1 Color table number 2		
		1	1 0 Color table number 3		
4	I/E	0	1 1 Color table number 4		
		1	Character RAM (internal)		
3	M/G1	0	External ROM		ROM selection
		1	MG1 MG0		
2	M/G0	0	0 0 Character (only when transparent character is specified.)		
		1	0 1 Graphic 1 only		
		1			
1	-	0			
0	-	0			

(5) Second byte-[4]

DA0 to 7	Register	Content		Notes
		State	Function	
7	-	0		
6	-	0		
5	C13 [MSB]	0		Character code specification
		1		
4	C12	0		
		1		
3	C11	0		
		1		
2	C10	0		
		1		
1	C9	0		
		1		
0	C8	0		
		1		

*: This resistor is set to the all bits zero state when the IC is reset by the $\overline{\text{RST}}$ pin.

LC74736PT

(6) Second byte-[5]

DA0 to 7	Register	Content		Notes
		State	Function	
7	C7	0	Character code External ROM: 16384 characters 0000 to 3FFF (hexadecimal) 0 to 16383 Character RAM (internal): QVGA mode: 0 to 3, hexadecimal, 4 characters WVGA mode: 0 hexadecimal, 1 character * Transparent character specification I/E = 0 (Internal character RAM) M/G10 = 00 (Character) Code = FF (hexadecimal)	Character code specification
		1		
6	C6	0		
		1		
5	C5	0		
		1		
4	C4	0		
		1		
3	C3	0		
		1		
2	C2	0		
		1		
1	C1	0		
		1		
0	C0 [LSB]	0		
		1		

*: This resistor is set to the all bits zero state when the IC is reset by the $\overline{\text{RST}}$ pin.

LC74736PT

9 COMMAND20 (System control setting command)

(1) First byte

DA0 to 7	Register	Content		Notes
		State	Function	
7	-	1	Command 2 identification code	
6	-	0	System control settings	
5	-	1		
4	-	0		
3	-	0	Sub-identification code 0	
2	-	0		
1	-	0		
0	-	0		

(2) Second byte

DA0 to 7	Register	Content		Notes
		State	Function	
7	TST MD2	0	Normal operation	Do not use test mode. This bit must always be set to 0.
		1	Test mode 2	
6	TST MD1	0	Normal operation	Do not use test mode. This bit must always be set to 0.
		1	Test mode 1	
5	SYS RST	0		The registers are reset when the \overline{CS} pin is low. The reset state is cleared when the \overline{CS} pin goes high.
		1	Reset all registers (All bits set to 0.)	
4	FRM ERS	0		Applications must provide a wait time of about 1ms. Use DSPOFF to execute this operation.
		1	Erase FontRAM (Sets all values to 00.)	
3	CT ERS	0		Applications must provide a wait time of about 1ms. Use DSPOFF to execute this operation.
		1	Erase the color table. (Sets all values to 00.)	
2	SRM ERS	0		Applications must provide a wait time of about 1ms. Use DSPOFF to execute this operation.
		1	Erase sub-RAM. (Sets all values to 00.) Wallpaper	
1	MRM ER2	0		Applications must provide a wait time of about 1ms. Use DSPOFF to execute this operation.
		1	Erase main RAM. (Sets all values to 00.) Main screen	
0	MRM ER1	0		Applications must provide a wait time of about 1ms. Use DSPOFF to execute this operation.
		1	Erase main RAM. (Sets all values to 00.) Main screen	

*: This resistor is set to the all bits zero state when the IC is reset by the \overline{RST} pin.

LC74736PT

10 COMMAND21 (Display control setting command)

(1) First byte

DA0 to 7	Register	Content		Notes
		State	Function	
7	-	1	Command 2 identification code	
6	-	0	Display control	
5	-	1		
4	-	0		
3	-	0	Extended command 1 identification code	
2	-	0		
1	-	0		
0	-	1		

(2) Second byte

DA0 to 7	Register	Content			Notes
		State	Function		
7	BK12	0	BK12	BK02	Blinking period Blinking period main 2 Specified for screen units.
		1	0	0	
6	BK02	0	0	1	1/32 1/64
		1	1	0	
5	BK11	0	BK11	BK01	Blinking period Blinking period main 1 Specified for screen units.
		1	0	0	
4	BK01	0	0	1	1/32 1/64
		1	1	0	
3	DSP BG	0	Display off		Screen background color
		1	Display on		
2	DSP GS	0	Display off		Subscreen (wallpaper)
		1	Display on		
1	DSP GM2	0	Display off		Main screen 2
		1	Display on		
0	DSP GM1	0	Display off		Main screen 1
		1	Display on		

*: This resistor is set to the all bits zero state when the IC is reset by the $\overline{\text{RST}}$ pin.





LC74736PT

11 COMMAND22 (I/O polarity control 1 setting command)

(1) First byte

DA0 to 7	Register	Content		Notes
		State	Function	
7	-	1	Command 2 identification code I/O polarity control 1	
6	-	0		
5	-	1		
4	-	0		
3	-	0	Extended command 2 identification code	
2	-	0		
1	-	1		
0	-	0		

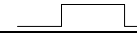
(2) Second byte

DA0 to 7	Register	Content		Notes
		State	Function	
7	-	0		
6	BLOP	0	BLK output: positive polarity 	BLK output polarity selection
		1	BLK output: negative polarity 	
5	BLO2	0	BLO210 BLK output	BLK output control Character, character background, and graphic output control. Border specification is enabled when character background output is selected.
4	BLO1	0	0 0 0 Normal character.+character background+graphic	
		1	0 0 1 Character only	
3	BLO0	0	0 1 0 Character background only	
			0 1 1 Graphic only	
		1	1 0 0 Character+character background only 1 0 1 Character+graphic only 1 1 0 Character background+graphic only	
2	CKP	0	Clock input: positive polarity	
		1	Clock input: negative polarity	
1	VIP	0	VSYNC input: negative polarity 	VSYNC input polarity selection
		1	VSYNC input: positive polarity 	
0	HIP	0	HSYNC input: negative polarity 	HSYNC input polarity selection
		1	HSYNC input: positive polarity 	

*: This resistor is set to the all bits zero state when the IC is reset by the RST pin.

LC74736PT

12 COMMAND23 (Screen background color setting command)

(1) First byte

DA0 to 7	Register	Content		Notes
		State	Function	
7	-	1	Command 2 identification code	
6	-	0	Screen background color	
5	-	1		
4	-	0		
3	-	0	Extended command 3 identification code	
2	-	0		
1	-	1		
0	-	1		

(2) Second byte

DA0 to 7	Register	Content		Notes
		State	Function	
7	DPM HC1	0	HC1 0 Characters	Main screen display area specification Horizontal direction
		1	0 0 30 characters (1D, hexadecimal)	
6	DPM HC0	0	0 1 33 characters (20, hexadecimal)	
		1	1 0 34 characters (21, hexadecimal)	
5	BGC T1	0	T1 T0 Color table setting	Screen background color Color table setting
		1	0 0 Color table number 1	
4	BGC T0	0	0 1 Color table number 2	
		1	1 0 Color table number 3 1 1 Color table number 4	
3	BGC3	0	Screen background color 0000 to 1111 0 to F (hexadecimal)	Screen background color setting 1 of 16 colors may be selected.
		1		
2	BGC2	0		
		1		
1	BGC1	0		
		1		
0	BGC0	0		
		1		

*: This resistor is set to the all bits zero state when the IC is reset by the RST pin.

LC74736PT

13 COMMAND24 (I/O polarity control 2 setting command)

(1) First byte

DA0 to 7	Register	Content		Notes
		State	Function	
7	-	1	Command 2 identification code I/O polarity control 2	
6	-	0		
5	-	1		
4	-	0		
3	-	0	Extended command 4 identification code	
2	-	1		
1	-	0		
0	-	0		

(2) Second byte

DA0 to 7	Register	Content		Notes
		State	Function	
7	DPM MD	0	QVGA mode (16×16 dots)	Display mode selection
		1	WVGA mode (24×32 dots)	
6	DPM VC	0	15 lines	Mmain screen display area specification Vertical
		1	18 lines	
5	D/A SEL	0	D/A on	D/A converter use/no-use selection
		1	D/A off	
4	SBG SL	0	Repeated display (wallpaper)	Subscreen display selection COM29-2: Display area specification
		1	Cursor display (sprite display) QVGA: Horizontal 4 characters×Vertical 4 lines (maximum) WVGA: Horizontal 2 characters×Vertical 2 lines (maximum)	
3	GD2	0	GD2 1 0 Screen display [upper⇔lower]	Screen display order selection
		1	0 0 0 Main 1, Main 2, Wallpaper	
2	GD1	0	0 0 1 Main 2, Main 1, Wallpaper	
		1	0 1 0 Wallpaper, Main 1, Main 2	
1	GD0	0	0 1 1 Wallpaper, Main 2, Main 1	
		1	1 0 0 Main 1, Wallpaper, Main 2	
0	CKOP	0	1 0 1 Main 2, Wallpaper, Main 1	
		1	Clock output: positive polarity	Clock output polarity selection
		1	Clock output: negative polarity	

*: This resistor is set to the all bits zero state when the IC is reset by the RST pin.

LC74736PT

14 COMMAND25 (Output control 1 setting command)

(1) First byte

DA0 to 7	Register	Content		Notes
		State	Function	
7	-	1	Command 2 identification code	
6	-	0	Output control 1	
5	-	1		
4	-	0		
3	-	0	Extended command 5 identification code	
2	-	1		
1	-	0		
0	-	1		

(2) Second byte

DA0 to 7	Register	Content		Notes
		State	Function	
7	CEHSL	0	Normal operation	$\overline{\text{CE}}$ pin
		1	$\overline{\text{CE}}$ pin held fixed at the high level	
6	TOKSL	0	Normal mode	Transparent mode specification Specifies effective color table with COMN27-2.
		1	Transmissive mode The color specified at address 0 in color table No. 1 is displayed in the transmissive state.	
5	VIPSL	0	Falling edge detection	Selects the detection polarity for the VSYNC signal.
		1	Rising edge detection	
4	LCS OF2	0	LC oscillator: Normal operation (H sync)	LC oscillator STOP control When external clock is input.
		1	LC oscillator: STOP state (OFF) RSTLC also	
3	OTMD1	0	OTMD1 OTMD0 Output 0 0 Normal	A0 to A19, CE, OE output selection
		1	0 1 Disabled	
2	OTMD0	0	1 0 Disabled	
		1	1 1 High-impedance state	
1	LCS STP	0	LC oscillator: Normal operation (H sync.)	LC oscillator STOP control Enabled when display is off
		1	LC oscillator: Always STOP state	
0	LCS OFF	0	LC oscillator: Normal operation (H sync.)	LC oscillator STOP control When external clock is input.
		1	LC oscillator: STOP state (OFF) LCSTOP only	

*: This resistor is set to the all bits zero state when the IC is reset by the $\overline{\text{RST}}$ pin.

LC74736PT

15 COMMAND26 (Output control 2 setting command)

(1) First byte

DA0 to 7	Register	Content		Notes
		State	Function	
7	-	1	Command 2 identification code Output control 1	
6	-	0		
5	-	1		
4	-	0		
3	-	0	Extended command 6 identification code	
2	-	1		
1	-	1		
0	-	0		

(2) Second byte

DA0 to 7	Register	Content		Notes
		State	Function	
7	HFT OFF	0	HFTOT output on	HFTOT output setting
		1	HFTOT output off=low	
6	BLK OFF	0	BLK output on	BLK output setting
		1	BLK output off=low	
5	BLD2	0	BLD2 1 0 BLK output delay	BLK output delay
		1	0 0 0 ±0 (analog)	
4	BLD1	0	0 0 1 +1	
		1	0 1 0 +2	
3	BLD0	0	0 1 1 -1 (digital)	
		1	1 0 0 -2	
2	OTM2	0	Output off=Low	CLKout output output control
		1	Normal output	
1	ROT OFF	0	External ROM address, OE, CE output on	External ROM address output setting
		1	External ROM address, OE, CE output off=low	
0	DOT OFF	0	Digital RGB output on	Digital RGB output setting
		1	Digital RGB output off=low	

*: This resistor is set to the all bits zero state when the IC is reset by the $\overline{\text{RST}}$ pin.

LC74736PT

16 COMMAND27 (Output control 3 setting command)

(1) First byte

DA0 to 7	Register	Content		Notes
		State	Function	
7	-	1	Command 2 identification code Output control 1	
6	-	0		
5	-	1		
4	-	0		
3	-	0	Extended command 7 identification code	
2	-	1		
1	-	1		
0	-	1		

(2) Second byte

DA0 to 7	Register	Content		Notes
		State	Function	
7	-	0		
6	HFT OD2	0	HFTOD2 1 0	HFTOT output delay
			0 0 0 ±0 (analog)	
			0 0 1 +1	
			0 1 0 +2	
5	HFT OD1	0	0 1 1 -1 (digital)	
		1		
4	HFT OD0	0	1 0 0 -2	
		1		
3	TOK CB4	0	Address 0000: Normal color	Transparent color specification or specifiable color table No. 4 COM25-2 Enabled by setting TOKSL to 1.
		1	Address 0000: Transparent color	
2	TOK CB3	0	Address 0000: Normal color	Transparent color specification or specifiable color table No. 3 COM25-2 Enabled by setting TOKSL to 1.
		1	Address 0000: Transparent color	
1	TOK CB2	0	Address 0000: Normal color	Transparent color specification or specifiable color table No. 2 COM25-2 Enabled by setting TOKSL to 1.
		1	Address 0000: Transparent color	
0	TOK CB1	0	Address 0000: Normal color	Transparent color specification or specifiable color table No. 1 COM25-2 Enabled by setting TOKSL to 1.
		1	Address 0000: Transparent color	

*: This resistor is set to the all bits zero state when the IC is reset by the \overline{RST} pin.

LC74736PT

17 COMMAND28 (Output control 4 setting command)

(1) First byte

DA0 to 7	Register	Content		Notes
		State	Function	
7	-	1	Command 2 identification code Output control 1	
6	-	0		
5	-	1		
4	-	0		
3	-	1	Extended command 8 identification code	
2	-	0		
1	-	0		
0	-	0		

(2) Second byte

DA0 to 7	Register	Content		Notes
		State	Function	
7	HPG 9	0	Screen background color H position msb 0	H position screen background color msb
		1	Screen background color H position msb 1	
6	HPS 9	0	Subscreen H position msb 0	H position subscreen msb
		1	Subscreen H position msb 1	
5	HPM2 29	0	Main screen 2 H position msb 0	H position main screen 2 msb
		1	Main screen 2 H position msb 1	
4	HPM1 19	0	Main screen 1 H position msb 0	H position main screen 1 msb
		1	Main screen 1 H position msb 1	
3	VPG 8	0	Screen background V position msb 0	V position screen background color msb
		1	Screen background V position msb 1	
2	VPS 8	0	Subscreen V position msb 0	V position subscreen msb
		1	Subscreen V position msb 1	
1	VPM2 28	0	Main screen 2 V position msb 0	V position main screen 2 msb
		1	Main screen 2 V position msb 1	
0	VPM1 18	0	Main screen 1 V position msb 0	V position main screen 1 msb
		1	Main screen 1 V position msb 1	

*: This resistor is set to the all bits zero state when the IC is reset by the $\overline{\text{RST}}$ pin.

LC74736PT

18 COMMAND29 (Output control 5 setting command)

(1) First byte

DA0 to 7	Register	Content		Notes
		State	Function	
7	-	1	Command 2 identification code Output control 1	
6	-	0		
5	-	1		
4	-	0		
3	-	1	Extended command 9 identification code	
2	-	0		
1	-	0		
0	-	1		

(2) Second byte

DA0 to 7	Register	Content		Notes
		State	Function	
7	-	0		
6	SVH1	0	SVH1 SVH0 Display area QVGA WVGA	Subscreen vertical direction display range selection QVGA: 4 lines (maximum) WVGA: 2 lines (maximum)
		1		
5	SVH0	0	0 0 1 line -	
		1	0 1 2 line - 1 0 3 line 1 line 1 1 4 line 2 line	
4	SHH1	0	SHH1 SHH0 Display area QVGA WVGA	Subscreen horizontal direction display range selection QVGA: 4 characters (maximum) WVGA: 2 characters (maximum)
		1		
3	SHH0	0	0 0 1 character -	
		1	0 1 2 characters - 1 0 3 characters 1 character 1 1 4 characters 2 characters	
2	-	0		
1	-	0		
0	ML CHG	0	LSB first	3-wire control transfer direction selection
		1	MSB first	

*: This resistor is set to the all bits zero state when the IC is reset by the $\overline{\text{RST}}$ pin.

LC74736PT

18 COMMAND2A (Display area control 1 setting command)

(1) First byte

DA0 to 7	Register	Content		Notes
		State	Function	
7	-	1	Command 2 identification code Output control 1	
6	-	0		
5	-	1		
4	-	0		
3	-	1	Extended command A identification code	
2	-	0		
1	-	1		
0	-	0		

(2) Second byte

DA0 to 7	Register	Content			Notes	
		State	Function			
7	-	0				
6	HIN DIN	0	Normal (LC oscillator control route)		HSYNC input selection Direct taking-in specification (1) must be used in modes other than LC oscillator.	
		1	Direct taking in			
5	HI D1	0	HID1	HID0	delay	HSYNC taking in Enabled when HINDIN is set to 1.
		1				
4	HI D0	0	0	1	+1	
		1	1	0	+2	
3	VI D1	0	VID1	VID0	delay	VSYNC taking in
		1				
2	VI D0	0	0	1	+1	
		1	1	1	+3	
1	-	0				
0	-	0				

*: This resistor is set to the all bits zero state when the IC is reset by the $\overline{\text{RST}}$ pin.

LC74736PT

25 COMMAND30 (Main screen 1: vertical display start position setting command)

(1) First byte

DA0 to 7	Register	Content		Notes
		State	Function	
7	-	1	Command 3 identification code	
6	-	0	Main screen 1 vertical display start position setting	
5	-	1		
4	-	1		
3	-	0	Extended command 0 identification code	
2	-	0		
1	-	0		
0	-	0		

(2) Second byte

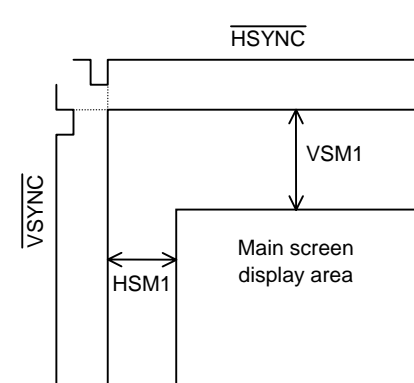
DA0 to 7	Register	Content		Notes
		State	Function	
7	VPM17	0	The vertical display start position, VSM 1, is given by: $VSM1 = 1H \times (\sum_{n=0}^8 VPM1n)$ 	Main screen 1 The vertical display start position is specified by the 9 bits VPM18 to VPM10. The weight of the LSB is 1H. This setting applies in screen units.
		1		
6	VPM16	0		
		1		
5	VPM15	0		
		1		
4	VPM14	0		
		1		
3	VPM13	0		
		1		
2	VPM12	0		
		1		
1	VPM11	0		
		1		
0	VPM10 (LSB)	0		
		1		

*: This resistor is set to the all bits zero state when the IC is reset by the \overline{RST} pin.

LC74736PT

26 COMMAND31 (Main screen 1: horizontal display start position setting command)

(1) First byte

DA0 to 7	Register	Content		Notes
		State	Function	
7	-	1	Command 3 identification code	
6	-	0	Main screen: horizontal display start position setting	
5	-	1		
4	-	1		
3	-	0	Extended command 1 identification code	
2	-	0		
1	-	1		
0	HPM18	0		
		1		

(2) Second byte

DA0 to 7	Register	Content		Notes	
		State	Function		
7	HPM17	0	The horizontal display start position, HSM1, is given by:	Main screen 1 The horizontal display start position is specified by the 10 bits HPM19 to HPM10. The weight of the LSB is 1TC. This setting applies in screen units.	
		1	$HSM1=1Tc \times (\sum_{n=0}^9 HPM1n) + \alpha$		
6	HPM16	0	$\alpha=45Tc(QVGA)$		
		1			$41Tc(WVGA)$
5	HPM15	0	Tc: The input clock frequency in operating mode.		
		1			
4	HPM14	0	Setting disable range		
		1			<table style="width: 100%; border: none;"> <tr> <td style="width: 30%;"></td> <td style="width: 35%; text-align: center;">QVGA</td> <td style="width: 35%; text-align: center;">WVGA</td> </tr> </table>
	QVGA	WVGA			
3	HPM13	0	Sub H 0 character 00HEX 00HEX		
		1	Sub H 1 character 00 to 05HEX 00 to 15HEX (00 to 0CHEX)		
2	HPM12	0	Sub H 2 characters 00 to 0DHEX 00 to 2CHEX (00 to 1CHEX)		
		1			
1	HPM11	0	Sub H 3 characters 00 to 15HEX		
		1	Sub H 4 characters 00 to 1DHEX		
0	HPM10 (LSB)	0	The values in parentheses apply when ROM access		
		1	No. 2 and No. 3 are set.		

*: This resistor is set to the all bits zero state when the IC is reset by the \overline{RST} pin.

LC74736PT

27 COMMAND32 (Main screen 2: vertical display start position setting command)

(1) First byte

DA0 to 7	Register	Content		Notes
		State	Function	
7	-	1	Command 3 identification code	
6	-	0	Main screen 2 vertical display start position setting	
5	-	1		
4	-	1		
3	-	0	Extended command 2 identification code	
2	-	1		
1	-	0		
0	-	0		

(2) Second byte

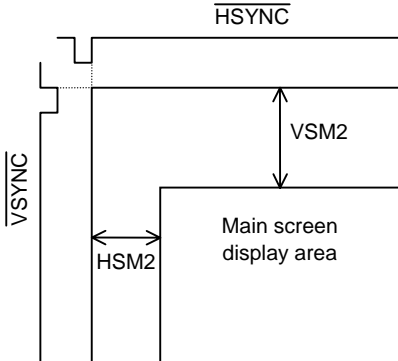
DA0 to 7	Register	Content		Notes
		State	Function	
7	VPM27	0	The vertical display start position, VSM2, is given by: $VSM2 = 1H \times (\sum_{n=0}^8 VPM2n)$ 	Main screen 2 The vertical display start position is specified by the 9 bits VPM28 to VPM20. The weight of the LSB is 1H. This setting applies in screen units.
		1		
6	VPM26	0		
		1		
5	VPM25	0		
		1		
4	VPM24	0		
		1		
3	VPM23	0		
		1		
2	VPM22	0		
		1		
1	VPM21	0		
		1		
0	VPM20 (LSB)	0		
		1		

*: This resistor is set to the all bits zero state when the IC is reset by the \overline{RST} pin.

LC74736PT

28 COMMAND33 (Main screen 2: horizontal display start position setting command)

(1) First byte

DA0 to 7	Register	Content		Notes
		State	Function	
7	-	1	Command 3 identification code	
6	-	0	Main screen: horizontal display start position setting	
5	-	1		
4	-	1		
3	-	0	Extended command 3 identification code	
2	-	1		
1	-	1		
0	HPM28	0		
		1		

(2) Second byte

DA0 to 7	Register	Content		Notes				
		State	Function					
7	HPM27	0	The horizontal display start position, HSM2, is given by:	Main screen 2 The horizontal display start position is specified by the 10 bits HPM29 to HPM20. The weight of the LSB is 1Tc. This setting applies in screen units.				
		1	$HSM2=1Tc \times (\sum_{n=0}^9 HPM2n) + \alpha$					
6	HPM26	0	$\alpha=45Tc(QVGA)$					
		1	$41Tc(WVGA)$					
5	HPM25	0	Tc: The input clock frequency in operating mode.					
		1						
4	HPM24	0	Setting disable range					
		1	<table style="width: 100%; border: none;"> <tr> <td style="width: 30%;"></td> <td style="width: 35%; text-align: center;">QVGA</td> <td style="width: 35%; text-align: center;">WVGA</td> </tr> <tr> <td>Sub H 0 character</td> <td style="text-align: center;">00HEX</td> <td style="text-align: center;">00HEX</td> </tr> </table>			QVGA	WVGA	Sub H 0 character
	QVGA	WVGA						
Sub H 0 character	00HEX	00HEX						
3	HPM23	0	Sub H 1 character 00 to 05HEX 00 to 15HEX					
		1	(00 to 0CHEX)					
2	HPM22	0	Sub H 2 characters 00 to 0DHEX 00 to 2CHEX					
		1	(00 to 1CHEX)					
1	HPM21	0	Sub H 3 characters 00 to 15HEX					
		1	Sub H 4 characters 00 to 1DHEX					
0	HPM20 (LSB)	0	The values in parentheses apply when ROM access					
		1	No. 2 and No. 3 are set.					

*: This resistor is set to the all bits zero state when the IC is reset by the \overline{RST} pin.

LC74736PT

29 COMMAND34 (Subscreen: vertical display start position setting command)

(1) First byte

DA0 to 7	Register	Content		Notes
		State	Function	
7	-	1	Command 3 identification code	
6	-	0	Subscreen: vertical display start position setting	
5	-	1		
4	-	1		
3	-	1	Extended command 4 identification code	
2	-	0		
1	-	0		
0	-	0		

(2) Second byte

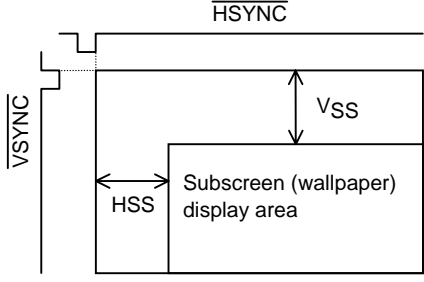
DA0 to 7	Register	Content		Notes
		State	Function	
7	VPS7	0	The vertical display start position, V_{SS} , is given by: $V_{SS} = 1H \times \left(\sum_{n=0}^8 2^n VPS_n \right)$ 	Subscreen (wallpaper) The vertical display start position is specified by the 9 bits VPS8 to VPS0. The weight of the LSB is 1H. This setting applies in screen units.
		1		
6	VPS6	0		
		1		
5	VPS5	0		
		1		
4	VPS4	0		
		1		
3	VPS3	0		
		1		
2	VPS2	0		
		1		
1	VPS1	0		
		1		
0	VPS0 (LSB)	0		
		1		

*: This resistor is set to the all bits zero state when the IC is reset by the \overline{RST} pin.

LC74736PT

30 COMMAND35 (Subscreen: horizontal display start position setting command)

(1) First byte

DA0 to 7	Register	Content		Notes
		State	Function	
7	-	1	Command 3 identification code	
6	-	0	Subscreen: horizontal display start position setting	
5	-	1		
4	-	1		
3	-	1	Extended command 5 identification code	
2	-	0		
1	-	1		
0	HPS8	0		
		1		

(2) Second byte

DA0 to 7	Register	Content		Notes						
		State	Function							
7	HPS7	0	The horizontal display start position, HSS, is given by:	Subscreen (wallpaper) The horizontal display start position is specified by the 9 bits HPS9 to HPS0. The weight of the LSB is 1TC. This setting applies in screen units.						
		1	$HSS=1Tc \times (\sum_{n=0}^9 HPSn) + \alpha$							
6	HPS6	0	$\alpha=15Tc$							
		1	Tc: The input clock frequency in operating mode.							
5	HPS5	0	Setting disable range							
		1								
4	HPS4	0	<table style="width: 100%; border: none;"> <tr> <td style="width: 33%;"></td> <td style="width: 33%; text-align: center;">QVGA</td> <td style="width: 33%; text-align: center;">WVGA</td> </tr> <tr> <td>Sub H 1 character</td> <td style="text-align: center;">00 to 13HEX</td> <td style="text-align: center;">00 to 22HEX (00 to 1AHEX)</td> </tr> </table>			QVGA	WVGA	Sub H 1 character	00 to 13HEX	00 to 22HEX (00 to 1AHEX)
			QVGA		WVGA					
Sub H 1 character	00 to 13HEX	00 to 22HEX (00 to 1AHEX)								
3	HPS3	0	<table style="width: 100%; border: none;"> <tr> <td style="width: 33%;"></td> <td style="width: 33%; text-align: center;">00 to 1BHEX</td> <td style="width: 33%; text-align: center;">00 to 3AHEX (00 to 2AHEX)</td> </tr> </table>			00 to 1BHEX	00 to 3AHEX (00 to 2AHEX)			
			00 to 1BHEX		00 to 3AHEX (00 to 2AHEX)					
1										
2	HPS2	0	Sub H 3 characters 00 to 23HEX							
		1	Sub H 4 characters 00 to 2BHEX							
1	HPS1	0	The values in parentheses apply when ROM access No. 2 and No. 3 are set.							
		1								
0	HPS0 (LSB)	0								
		1								

*: This resistor is set to the all bits zero state when the IC is reset by the \overline{RST} pin.

LC74736PT

31 COMMAND36 (Screen background color: vertical display start position setting command)

(1) First byte

DA0 to 7	Register	Content		Notes
		State	Function	
7	-	1	Command 3 identification code	
6	-	0	Screen background color: vertical display start position setting	
5	-	1		
4	-	1		
3	-	1	Extended command 6 identification code	
2	-	1		
1	-	0		
0	-	0		

(2) Second byte

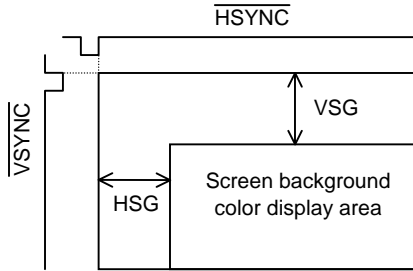
DA0 to 7	Register	Content		Notes
		State	Function	
7	VPG7	0	The vertical display start position, VSG, is given by: $VSG = 1H \times (\sum_{n=0}^8 2^n VPG_n)$ 	Screen background color The vertical display start position is specified by the 8 bits VPG8 to VPG0. The weight of the LSB is 1H. This setting applies in screen units.
		1		
6	VPG6	0		
		1		
5	VPG5	0		
		1		
4	VPG4	0		
		1		
3	VPG3	0		
		1		
2	VPG2	0		
		1		
1	VPG1	0		
		1		
0	VPG0 (LSB)	0		
		1		

*: This resistor is set to the all bits zero state when the IC is reset by the \overline{RST} pin.

LC74736PT

32 COMMAND37 (Screen background color: horizontal display start position setting command)

(1) First byte

DA0 to 7	Register	Content		Notes
		State	Function	
7	-	1	Command 3 identification code Screen background color: horizontal display start position setting	
6	-	0		
5	-	1		
4	-	1		
3	-	1	Extended command 7 identification code	
2	-	1		
1	-	1		
0	HPG8	0		
		1		

(2) Second byte

DA0 to 7	Register	Content		Notes
		State	Function	
7	HPG7	0	The horizontal display start position, HSG, is given by: $HSG = 1Tc \times (\sum_{n=0}^9 HPG_n)$ Tc: The input clock frequency in operating mode.	Screen background color The horizontal display start position is specified by the 10 bits HPG9 to HPG0. The weight of the LSB is 1TC. This setting applies in screen units.
		1		
6	HPG6	0		
		1		
5	HPG5	0		
		1		
4	HPG4	0		
		1		
3	HPG3	0		
		1		
2	HPG2	0		
		1		
1	HPG1	0		
		1		
0	HPG0 (LSB)	0		
		1		

*: This resistor is set to the all bits zero state when the IC is reset by the \overline{RST} pin.

LC74736PT

33 COMMAND40 (Character size control setting command)

(1) First byte

DA0 to 7	Register	Content		Notes
		State	Function	
7	-	1	Command 4 identification code Character size control settings	
6	-	1		
5	-	0		
4	-	0		
3	-	0	Extended command 0 identification code	
2	-	0		
1	-	0		
0	-	0		

(2) Second byte

DA0 to 7	Register	Content			Notes	
		State	Function			
7	-	0				
6	-	0				
5	-	0				
4	-	0				
3	SZV1	0	SZV1	SZV0	Character size	Specifies the character size in the vertical direction. This setting applies in line units.
		1	0	0	1×	
2	SZV0	0	0	1	2×	
		1	1	0	3×	
1	SZH1	0	SZH1	SZH0	Character size	Specifies the character size in the horizontal direction. This setting applies in line units.
		1	0	0	1×	
0	SZH0	0	0	1	2×	
		1	1	1	4×	

*: This resistor is set to the all bits zero state when the IC is reset by the $\overline{\text{RST}}$ pin.

LC74736PT

34 COMMAND41 (Character size line U control main 1 setting command)

(1) First byte

DA0 to 7	Register	Content		Notes
		State	Function	
7	-	1	Command 4 identification code	
6	-	1	Character size line U control main 1	
5	-	0		
4	-	0		
3	-	0	Extended command 1 identification code	
2	-	0		
1	-	0		
0	-	1		

(2) Second byte

DA0 to 7	Register	Content		Notes
		State	Function	
7	LSZ7	0	Do not set for line 8.	Character size line setting control Upper lines
		1	Set for line 8.	
6	LSZ6	0	Do not set for line 7.	
		1	Set for line 7.	
5	LSZ5	0	Do not set for line 6.	
		1	Set for line 6.	
4	LSZ4	0	Do not set for line 5.	
		1	Set for line 5.	
3	LSZ3	0	Do not set for line 4.	
		1	Set for line 4.	
2	LSZ2	0	Do not set for line 3.	
		1	Set for line 3.	
1	LSZ1	0	Do not set for line 2.	
		1	Set for line 2.	
0	LSZ0	0	Do not set for line 1.	
		1	Set for line 1.	

*: This resistor is set to the all bits zero state when the IC is reset by the $\overline{\text{RST}}$ pin.

LC74736PT

35 COMMAND42 (Character size line D control main 1 setting command)

(1) First byte

DA0 to 7	Register	Content		Notes
		State	Function	
7	-	1	Command 4 identification code	
6	-	1	Character size line D control main 1	
5	-	0		
4	-	0		
3	-	0	Extended command 2 identification code	
2	-	0		
1	-	1		
0	-	0		

(2) Second byte

DA0 to 7	Register	Content		Notes
		State	Function	
7	LSZ15	0	Do not set for line 16.	Character size line setting control Lower lines
		1	Set for line 16.	
6	LSZ14	0	Do not set for line 15.	
		1	Set for line 15.	
5	LSZ13	0	Do not set for line 14.	
		1	Set for line 14.	
4	LSZ12	0	Do not set for line 13.	
		1	Set for line 13.	
3	LSZ11	0	Do not set for line 12.	
		1	Set for line 12.	
2	LSZ10	0	Do not set for line 11.	
		1	Set for line 11.	
1	LSZ9	0	Do not set for line 10.	
		1	Set for line 10.	
0	LSZ8	0	Do not set for line 9.	
		1	Set for line 9.	

*: This resistor is set to the all bits zero state when the IC is reset by the $\overline{\text{RST}}$ pin.

LC74736PT

36 COMMAND43 (Character size line D2 control main 1 setting command)

(1) First byte

DA0 to 7	Register	Content		Notes
		State	Function	
7	-	1	Command 4 identification code Character size line D2 control main 1	
6	-	1		
5	-	0		
4	-	0		
3	-	0	Extended command 3 identification code	
2	-	0		
1	-	1		
0	-	1		

(2) Second byte

DA0 to 7	Register	Content		Notes
		State	Function	
7	-	0		
6	-	0		
5	-	0		
4	-	0		
3	-	0		
2	-	0		
1	LSZ17	0	Do not set for line 18.	
		1	Set for line 18.	
0	LSZ16	0	Do not set for line 17.	
		1	Set for line 17.	

*: This resistor is set to the all bits zero state when the IC is reset by the $\overline{\text{RST}}$ pin.

LC74736PT

37 COMMAND44 (Character size line U control main 2 setting command)

(1) First byte

DA0 to 7	Register	Content		Notes
		State	Function	
7	-	1	Command 4 identification code	
6	-	1	Character size line U control main 2	
5	-	0		
4	-	0		
3	-	0	Extended command 4 identification code	
2	-	1		
1	-	0		
0	-	0		

(2) Second byte

DA0 to 7	Register	Content		Notes
		State	Function	
7	LSZ7	0	Do not set for line 8.	Character size line setting control Upper lines
		1	Set for line 8.	
6	LSZ6	0	Do not set for line 7.	
		1	Set for line 7.	
5	LSZ5	0	Do not set for line 6.	
		1	Set for line 6.	
4	LSZ4	0	Do not set for line 5.	
		1	Set for line 5.	
3	LSZ3	0	Do not set for line 4.	
		1	Set for line 4.	
2	LSZ2	0	Do not set for line 3.	
		1	Set for line 3.	
1	LSZ1	0	Do not set for line 2.	
		1	Set for line 2.	
0	LSZ0	0	Do not set for line 1.	
		1	Set for line 1.	

*: This resistor is set to the all bits zero state when the IC is reset by the $\overline{\text{RST}}$ pin.

LC74736PT

38 COMMAND45 (Character size line D control main 2 setting command)

(1) First byte

DA0 to 7	Register	Content		Notes
		State	Function	
7	-	1	Command 4 identification code Character size line D control main 2	
6	-	1		
5	-	0		
4	-	0		
3	-	0	Extended command 5 identification code	
2	-	1		
1	-	0		
0	-	1		

(2) Second byte

DA0 to 7	Register	Content		Notes
		State	Function	
7	LSZ15	0	Do not set for line 16.	Character size line setting control Lower lines
		1	Set for line 16.	
6	LSZ14	0	Do not set for line 15.	
		1	Set for line 15.	
5	LSZ13	0	Do not set for line 14.	
		1	Set for line 14.	
4	LSZ12	0	Do not set for line 13.	
		1	Set for line 13.	
3	LSZ11	0	Do not set for line 12.	
		1	Set for line 12.	
2	LSZ10	0	Do not set for line 11.	
		1	Set for line 11.	
1	LSZ9	0	Do not set for line 10.	
		1	Set for line 10.	
0	LSZ8	0	Do not set for line 9.	
		1	Set for line 9.	

*: This resistor is set to the all bits zero state when the IC is reset by the $\overline{\text{RST}}$ pin.

LC74736PT

39 COMMAND46 (Character size line D control main 2 setting command)

(1) First byte

DA0 to 7	Register	Content		Notes
		State	Function	
7	-	1	Command 4 identification code Character size line D control main 2	
6	-	1		
5	-	0		
4	-	0		
3	-	0	Extended command 6 identification code	
2	-	1		
1	-	1		
0	-	0		

(2) Second byte

DA0 to 7	Register	Content		Notes
		State	Function	
7	-	0		Character size line setting control Lower lines 2
6	-	0		
5	-	0		
4	-	0		
3	-	0		
2	-	0		
1	LSZ17	0	Do not set for line 18.	
		1	Set for line 18.	
0	LSZ16	0	Do not set for line 17.	
		1	Set for line 17.	

*: This resistor is set to the all bits zero state when the IC is reset by the $\overline{\text{RST}}$ pin.

LC74736PT

46 COMMAND50 (Box control: U setting command)

(1) First byte

DA0 to 7	Register	Content		Notes
		State	Function	
7	-	1	Command 5 identification code Box control U settings	
6	-	1		
5	-	0		
4	-	1		
3	-	0	Extended command 0 identification code	
2	-	0		
1	-	0		
0	-	0		

(2) Second byte

DA0 to 7	Register	Content		Notes
		State	Function	
7	BXL W1	0	W1 W0	Box display: left side Dot width. This setting applies in line units. It does not depend on the character size.
		1	0 0 1 dot	
6	BXL W0	0	0 1 2 dots	
		1	1 0 3 dots 1 1 4 dots	
5	BXU CT1	0	BXUCT1 0	Box display: upper side Color table specification This setting applies in line units.
		1	0 0 Color table number 1	
4	BXU CT0	0	0 1 Color table number 2	
		1	1 0 Color table number 3 1 1 Color table number 4	
3	BXU C3	0	Box display: upper side color specification 0000 to 1111 0 to F (hexadecimal)	Box display: upper side Color specification This setting applies in line units.
		1		
2	BXU C2	0		
		1		
1	BXU C1	0		
		1		
0	BXU C0	0		
		1		

*: This resistor is set to the all bits zero state when the IC is reset by the $\overline{\text{RST}}$ pin.

LC74736PT

47 COMMAND51 (Box control: D setting command)

(1) First byte

DA0 to 7	Register	Content		Notes
		State	Function	
7	-	1	Command 5 identification code Box control D settings	
6	-	1		
5	-	0		
4	-	1		
3	-	0	Extended command 1 identification code	
2	-	0		
1	-	0		
0	-	1		

(2) Second byte

DA0 to 7	Register	Content		Notes
		State	Function	
7	BXR W1	0	W1 W0	Box display: right side Dot width. This setting applies in line units. It does not depend on the character size.
		1	0 0 1 dot	
6	BXR W0	0	0 1 2 dots	
		1	1 0 3 dots	
5	BXD CT1	0	BXDCT1 0	
		1	0 0 Color table number 1	
4	BXD CT0	0	0 1 Color table number 1	
		1	1 0 Color table number 3	
3	BXD C3	0	1 1 Color table number 4	
		1	Box display: lower side color specification 0000 to 1111 0 to F (hexadecimal)	
2	BXD C2	0		Box display: lower side Color table specification This setting applies in line units.
		1		
1	BXD C1	0		
		1		
0	BXD C0	0		
		1		

*: This resistor is set to the all bits zero state when the IC is reset by the $\overline{\text{RST}}$ pin.

LC74736PT

48 COMMAND52 (Box control: U line main 1 setting command)

(1) First byte

DA0 to 7	Register	Content		Notes
		State	Function	
7	-	1	Command 5 identification code Box control U line main 1 setting	
6	-	1		
5	-	0		
4	-	1		
3	-	0	Extended command 2 identification code	
2	-	0		
1	-	1		
0	-	0		

(2) Second byte

DA0 to 7	Register	Content		Notes
		State	Function	
7	LBX7	0	Do not set for line 8.	Box control line setting control Upper lines
		1	Set for line 8.	
6	LBX6	0	Do not set for line 7.	
		1	Set for line 7.	
5	LBX5	0	Do not set for line 6.	
		1	Set for line 6.	
4	LBX4	0	Do not set for line 5.	
		1	Set for line 5.	
3	LBX3	0	Do not set for line 4.	
		1	Set for line 4.	
2	LBX2	0	Do not set for line 3.	
		1	Set for line 3.	
1	LBX1	0	Do not set for line 2.	
		1	Set for line 2.	
0	LBX0	0	Do not set for line 1.	
		1	Set for line 1.	

*: This resistor is set to the all bits zero state when the IC is reset by the $\overline{\text{RST}}$ pin.

LC74736PT

49 COMMAND53 (Box control: D line main 1 setting command)

(1) First byte

DA0 to 7	Register	Content		Notes
		State	Function	
7	-	1	Command 5 identification code Box control D line main 1 setting	
6	-	1		
5	-	0		
4	-	1		
3	-	0	Extended command 3 identification code	
2	-	0		
1	-	1		
0	-	1		

(2) Second byte

DA0 to 7	Register	Content		Notes
		State	Function	
7	LBX15	0	Do not set for line 16.	Box control line setting control Lower lines
		1	Set for line 16.	
6	LBX14	0	Do not set for line 15.	
		1	Set for line 15.	
5	LBX13	0	Do not set for line 14.	
		1	Set for line 14.	
4	LBX12	0	Do not set for line 13.	
		1	Set for line 13.	
3	LBX11	0	Do not set for line 12.	
		1	Set for line 12.	
2	LBX10	0	Do not set for line 11.	
		1	Set for line 11.	
1	LBX9	0	Do not set for line 10.	
		1	Set for line 10.	
0	LBX8	0	Do not set for line 9.	
		1	Set for line 9.	

*: This resistor is set to the all bits zero state when the IC is reset by the $\overline{\text{RST}}$ pin.

LC74736PT

50 COMMAND54 (Box control: D2 line main 1 setting command)

(1) First byte

DA0 to 7	Register	Content		Notes
		State	Function	
7	-	1	Command 5 identification code Box control D2 line main 1 setting	
6	-	1		
5	-	0		
4	-	1		
3	-	0	Extended command 4 identification code	
2	-	1		
1	-	0		
0	-	0		

(2) Second byte

DA0 to 7	Register	Content		Notes
		State	Function	
7	-	0		Box control line setting control Lower lines
6	-	0		
5	-	0		
4	-	0		
3	-	0		
2	-	0		
1	LBX17	0	Do not set for line 18.	
		1	Set for line 18.	
0	LBX16	0	Do not set for line 17.	
		1	Set for line 17.	

*: This resistor is set to the all bits zero state when the IC is reset by the $\overline{\text{RST}}$ pin.

LC74736PT

51 COMMAND55 (Box control: U line main 2 setting command)

(1) First byte

DA0 to 7	Register	Content		Notes
		State	Function	
7	-	1	Command 5 identification code Box control U line main 2 setting	
6	-	1		
5	-	0		
4	-	1		
3	-	0	Extended command 5 identification code	
2	-	1		
1	-	0		
0	-	1		

(2) Second byte

DA0 to 7	Register	Content		Notes
		State	Function	
7	LBX7	0	Do not set for line 8.	Box control line setting control Upper lines
		1	Set for line 8.	
6	LBX6	0	Do not set for line 7.	
		1	Set for line 7.	
5	LBX5	0	Do not set for line 6.	
		1	Set for line 6.	
4	LBX4	0	Do not set for line 5.	
		1	Set for line 5.	
3	LBX3	0	Do not set for line 4.	
		1	Set for line 4.	
2	LBX2	0	Do not set for line 3.	
		1	Set for line 3.	
1	LBX1	0	Do not set for line 2.	
		1	Set for line 2.	
0	LBX0	0	Do not set for line 1.	
		1	Set for line 1.	

*: This resistor is set to the all bits zero state when the IC is reset by the $\overline{\text{RST}}$ pin.

LC74736PT

52 COMMAND56 (Box control: D line main 2 setting command)

(1) First byte

DA0 to 7	Register	Content		Notes
		State	Function	
7	-	1	Command 5 identification code Box control D line main 2 setting	
6	-	1		
5	-	0		
4	-	1		
3	-	0	Extended command 6 identification code	
2	-	1		
1	-	1		
0	-	0		

(2) Second byte

DA0 to 7	Register	Content		Notes
		State	Function	
7	LBX15	0	Do not set for line 16.	Box control line setting control Lower lines
		1	Set for line 16.	
6	LBX14	0	Do not set for line 15.	
		1	Set for line 15.	
5	LBX13	0	Do not set for line 14.	
		1	Set for line 14.	
4	LBX12	0	Do not set for line 13.	
		1	Set for line 13.	
3	LBX11	0	Do not set for line 12.	
		1	Set for line 12.	
2	LBX10	0	Do not set for line 11.	
		1	Set for line 11.	
1	LBX9	0	Do not set for line 10.	
		1	Set for line 10.	
0	LBX8	0	Do not set for line 9.	
		1	Set for line 9.	

*: This resistor is set to the all bits zero state when the IC is reset by the $\overline{\text{RST}}$ pin.

LC74736PT

53 COMMAND57 (Box control: D line main 2 setting command)

(1) First byte

DA0 to 7	Register	Content		Notes
		State	Function	
7	-	1	Command 5 identification code Box control D2 line main 2 setting	
6	-	1		
5	-	0		
4	-	1		
3	-	0	Extended command 7 identification code	
2	-	1		
1	-	1		
0	-	1		

(2) Second byte

DA0 to 7	Register	Content		Notes
		State	Function	
7	-	0		
6	-	0		
5	-	0		
4	-	0		
3	-	0		
2	-	0		
1	LBX17	0	Do not set for line 18.	
		1	Set for line 18.	
0	LBX16	0	Do not set for line 17.	
		1	Set for line 17.	

*: This resistor is set to the all bits zero state when the IC is reset by the $\overline{\text{RST}}$ pin.

LC74736PT

54 COMMAND58 (Line spacing control 1 setting command)

(1) First byte

DA0 to 7	Register	Content		Notes
		State	Function	
7	-	1	Command 5 identification code Line spacing control 1 setting	
6	-	1		
5	-	0		
4	-	1		
3	-	1	Extended command 8 identification code	
2	-	0		
1	-	0		
0	-	0		

(2) Second byte

DA0 to 7	Register	Content		Notes
		State	Function	
7	0	0		
6	GYB CK	0	Line spacing basic clock: 1V	Line spacing basic unit (clock) setting
		1	Line spacing basic clock: Depending on the character size	
5	GS1	0	GS1 GS0 Character Graphic	Line spacing mode setting This setting applies in line units
		1	0 0 Transparent Transparent	
4	GS0	0	0 1 Transparent Transparent	
		1	±1 (char. bkg color) ±1 (CB specified color) 1 0 Char. bkg. color CB specified color 1 1 Transparent Transparent (Border enabled)	
3	GY3	0	GY3 2 1 0 Line spacing (xH)	Line spacing dot number setting This setting applies in line units of 1H
		1	0 0 0 0 0	
2	GY2	0	0 0 0 1 -1 (upper) +1 (lower)	
		1	0 0 1 0 -1 +2	
1	GY1	0	0 0 1 1 -1 +3	
		1	0 1 0 0 -1 +4	
0	GY0	0	0 1 0 1 -1 +5	
		1	0 1 1 0 -1 +6	
		0	0 1 1 1 -1 +7	
		1	1 0 0 0 -1 +8	
		0	1 0 0 1 -1 +9	
		1	1 0 1 0 -1 +10	
		0	1 0 1 1 -1 +11	
1	1 1 0 0 -1 +12			
0	1 1 0 1 -1 +13			
1	1 1 1 0 -1 +14			
0	1 1 1 1 -1 +15			

*: This resistor is set to the all bits zero state when the IC is reset by the $\overline{\text{RST}}$ pin.

LC74736PT

55 COMMAND59 (Line spacing control 2 setting command)

(1) First byte

DA0 to 7	Register	Content		Notes
		State	Function	
7	-	1	Command 5 identification code	
6	-	1	Line spacing control 2 setting	
5	-	0		
4	-	1		
3	-	1	Extended command 9 identification code	
2	-	0		
1	-	0		
0	-	1		

(2) Second byte

DA0 to 7	Register	Content		Notes
		State	Function	
7	BXW D	0	Box display: lower side is 1 dot	Box display Lower side. This setting applies in line units. Depending on the character size
		1	Box display: lower side is 2 dots	
6	BXW U	0	Box display: upper side is 1 dot	Box display Upper side. This setting applies in line units. Depending on the character size
		1	Box display: upper side is 2 dots (Invalid when line spacing is specified.)	
5	GYHSL	0	Normal display	Line spacing area when halftone is specified This setting applies in line units. Transparent is supported except for 00.
		1	Line spacing area: halftone	
4	BXHSL	0	Normal display	Box area when halftone is specified This setting applies in line units
		1	Box area: halftone	
3	FCHSL	0	Depending on the character	Border area when halftone is specified This setting applies in line units
		1	Depending on the character background	
2	BXC3	0	Displayed in upper part of character lower line spacing	Box upper and lower display control 2 Valid when line spacing is specified. This setting applies in line units
		1	Displayed in lower part of character lower line spacing	
1	BXC2	0	Inside the character range (V1&V16 dots)	Box upper and lower display control 1 This setting applies in line units
		1	Outside the character range (line spacing area): Valid only when line spacing is specified.	
0	BXC1	0	Inside the character range	Box left and ight display control This setting applies in line units
		1	Outside the character range	

*: This resistor is set to the all bits zero state when the IC is reset by the RST pin.

LC74736PT

56 COMMAND5A (Line spacing control: U line main 1 setting command)

(1) First byte

DA0 to 7	Register	Content		Notes
		State	Function	
7	-	1	Command 5 identification code	
6	-	1	Control the line spacing control line setting U main 1	
5	-	0		
4	-	1		
3	-	1	Extended command A identification code	
2	-	0		
1	-	1		
0	-	0		

(2) Second byte

DA0 to 7	Register	Content		Notes
		State	Function	
7	LGY7	0	Do not set for line 8.	Control the line spacing control line setting Upper lines
		1	Set for line 8.	
6	LGY6	0	Do not set for line 7.	
		1	Set for line 7.	
5	LGY5	0	Do not set for line 6.	
		1	Set for line 6.	
4	LGY4	0	Do not set for line 5.	
		1	Set for line 5.	
3	LGY3	0	Do not set for line 4.	
		1	Set for line 4.	
2	LGY2	0	Do not set for line 3.	
		1	Set for line 3.	
1	LGY1	0	Do not set for line 2.	
		1	Set for line 2.	
0	LGY0	0	Do not set for line 1.	
		1	Set for line 1.	

*: This resistor is set to the all bits zero state when the IC is reset by the $\overline{\text{RST}}$ pin.

LC74736PT

57 COMMAND5B (Line spacing control: D line main 1 setting command)

(1) First byte

DA0 to 7	Register	Content		Notes
		State	Function	
7	-	1	Command 5 identification code	
6	-	1	Control the line spacing control line setting D main 1	
5	-	0		
4	-	1		
3	-	1	Extended command B identification code	
2	-	0		
1	-	1		
0	-	1		

(2) Second byte

DA0 to 7	Register	Content		Notes
		State	Function	
7	LGY15	0	Do not set for line 16.	Control the line spacing control line setting Lower lines
		1	Set for line 16.	
6	LGY14	0	Do not set for line 15.	
		1	Set for line 15.	
5	LGY13	0	Do not set for line 14.	
		1	Set for line 14.	
4	LGY12	0	Do not set for line 13.	
		1	Set for line 13.	
3	LGY11	0	Do not set for line 12.	
		1	Set for line 12.	
2	LGY10	0	Do not set for line 11.	
		1	Set for line 11.	
1	LGY9	0	Do not set for line 10.	
		1	Set for line 10.	
0	LGY8	0	Do not set for line 9.	
		1	Set for line 9.	

*: This resistor is set to the all bits zero state when the IC is reset by the $\overline{\text{RST}}$ pin.

LC74736PT

58 COMMAND5C (Line spacing control: D line main 1 setting command)

(1) First byte

DA0 to 7	Register	Content		Notes
		State	Function	
7	-	1	Command 5 identification code	
6	-	1	Control the line spacing control line setting D main 1	
5	-	0		
4	-	1		
3	-	1	Extended command C identification code	
2	-	1		
1	-	0		
0	-	0		

(2) Second byte

DA0 to 7	Register	Content		Notes
		State	Function	
7	-	0		
6	-	0		
5	-	0		
4	-	0		
3	-	0		
2	-	0		
1	LGY17	0	Do not set for line 18.	
		1	Set for line 18.	
0	LGY16	0	Do not set for line 17.	
		1	Set for line 17.	

*: This resistor is set to the all bits zero state when the IC is reset by the $\overline{\text{RST}}$ pin.

LC74736PT

59 COMMAND5D (Line spacing control: U line main 2 setting command)

(1) First byte

DA0 to 7	Register	Content		Notes
		State	Function	
7	-	1	Command 5 identification code	
6	-	1	Control the line spacing control line setting U main 2	
5	-	0		
4	-	1		
3	-	1	Extended command D identification code	
2	-	1		
1	-	0		
0	-	1		

(2) Second byte

DA0 to 7	Register	Content		Notes
		State	Function	
7	LGY7	0	Do not set for line 8.	Control the line spacing control line setting Upper lines
		1	Set for line 8.	
6	LGY6	0	Do not set for line 7.	
		1	Set for line 7.	
5	LGY5	0	Do not set for line 6.	
		1	Set for line 6.	
4	LGY4	0	Do not set for line 5.	
		1	Set for line 5.	
3	LGY3	0	Do not set for line 4.	
		1	Set for line 4.	
2	LGY2	0	Do not set for line 3.	
		1	Set for line 3.	
1	LGY1	0	Do not set for line 2.	
		1	Set for line 2.	
0	LGY0	0	Do not set for line 1.	
		1	Set for line 1.	

*: This resistor is set to the all bits zero state when the IC is reset by the $\overline{\text{RST}}$ pin.

LC74736PT

60 COMMAND5E (Line spacing control: D line main 2 setting command)

(1) First byte

DA0 to 7	Register	Content		Notes
		State	Function	
7	-	1	Command 5 identification code	
6	-	1	Control the line spacing control line setting D main 2.	
5	-	0		
4	-	1		
3	-	1	Extended command E identification code	
2	-	1		
1	-	1		
0	-	0		

(2) Second byte

DA0 to 7	Register	Content		Notes
		State	Function	
7	LGY15	0	Do not set for line 16.	Control the line spacing control line setting Lower lines
		1	Set for line 16.	
6	LGY14	0	Do not set for line 15.	
		1	Set for line 15.	
5	LGY13	0	Do not set for line 14.	
		1	Set for line 14.	
4	LGY12	0	Do not set for line 13.	
		1	Set for line 13.	
3	LGY11	0	Do not set for line 12.	
		1	Set for line 12.	
2	LGY10	0	Do not set for line 11.	
		1	Set for line 11.	
1	LGY9	0	Do not set for line 10.	
		1	Set for line 10.	
0	LGY8	0	Do not set for line 9.	
		1	Set for line 9.	

*: This resistor is set to the all bits zero state when the IC is reset by the $\overline{\text{RST}}$ pin.

LC74736PT

61 COMMAND5F (Line spacing control: D line main 2 setting command)

(1) First byte

DA0 to 7	Register	Content		Notes
		State	Function	
7	-	1	Command 5 identification code Control the line spacing control line setting D main 2.	
6	-	1		
5	-	0		
4	-	1		
3	-	1	Extended command F identification code	
2	-	1		
1	-	1		
0	-	1		

(2) Second byte

DA0 to 7	Register	Content		Notes
		State	Function	
7	-	0		
6	-	0		
5	-	0		
4	-	0		
3	-	0		
2	-	0		
1	LGY17	0	Do not set for line 18.	
		1	Set for line 18.	
0	LGY16	0	Do not set for line 17.	
		1	Set for line 17.	

*: This resistor is set to the all bits zero state when the IC is reset by the $\overline{\text{RST}}$ pin.

LC74736PT

62 COMMAND60 (Border control setting command)

(1) First byte

DA0 to 7	Register	Content		Notes
		State	Function	
7	-	1	Command 6 identification code Border control setting	
6	-	1		
5	-	1		
4	-	0		
3	-	0	Extended command 0 identification code	
2	-	0		
1	-	0		
0	-	0		

(2) Second byte

DA0 to 7	Register	Content		Notes
		State	Function	
7	BLK1	0	BLK1 BLK0 Border mode specification	Border mode specification This setting applies in line units.
		1	0 0 Normal display	
6	BLK0	0	0 1 Border	
		1	1 0 Shadow 1 (lower side)	
			1 1 Shadow 2 (lower and right sides)	
5	EG CT1	0	EGCT1 0	Border display Color table specification This setting applies in line units.
		1	0 0 Color table number 1	
4	EG CT0	0	0 1 Color table number 2	
		1	1 0 Color table number 3	
			1 1 Color table number 4	
3	EG C3	0	Border display: color specification 0000 to 1111 0 to F (hexadecimal)	Border display color specification This setting applies in line units.
		1		
2	EG C2	0		
		1		
1	EG C1	0		
		1		
0	EG C0	0		
		1		

*: This resistor is set to the all bits zero state when the IC is reset by the $\overline{\text{RST}}$ pin.

LC74736PT

63 COMMAND61 (Border control U line main 1 setting command)

(1) First byte

DA0 to 7	Register	Content		Notes
		State	Function	
7	-	1	Command 6 identification code	
6	-	1	Border line setting U main 1 control	
5	-	1		
4	-	0		
3	-	0	Extended command 1 identification code	
2	-	0		
1	-	0		
0	-	1		

(2) Second byte

DA0 to 7	Register	Content		Notes
		State	Function	
7	LFC7	0	Do not set for line 8.	Border control line settings control main 1 Upper lines
		1	Set for line 8.	
6	LFC6	0	Do not set for line 7.	
		1	Set for line 7.	
5	LFC5	0	Do not set for line 6.	
		1	Set for line 6.	
4	LFC4	0	Do not set for line 5.	
		1	Set for line 5.	
3	LFC3	0	Do not set for line 4.	
		1	Set for line 4.	
2	LFC2	0	Do not set for line 3.	
		1	Set for line 3.	
1	LFC1	0	Do not set for line 2.	
		1	Set for line 2.	
0	LFC0	0	Do not set for line 1.	
		1	Set for line 1.	

*: This resistor is set to the all bits zero state when the IC is reset by the $\overline{\text{RST}}$ pin.

LC74736PT

64 COMMAND62 (Border control D line main 1 setting command)

(1) First byte

DA0 to 7	Register	Content		Notes
		State	Function	
7	-	1	Command 6 identification code	
6	-	1	Border line setting D main 1 control	
5	-	1		
4	-	0		
3	-	0	Extended command 2 identification code	
2	-	0		
1	-	1		
0	-	0		

(2) Second byte

DA0 to 7	Register	Content		Notes
		State	Function	
7	LFC15	0	Do not set for line 16.	Border control line settings control main 1 Lower lines
		1	Set for line 16.	
6	LFC14	0	Do not set for line 15.	
		1	Set for line 15.	
5	LFC13	0	Do not set for line 14.	
		1	Set for line 14.	
4	LFC12	0	Do not set for line 13.	
		1	Set for line 13.	
3	LFC11	0	Do not set for line 12.	
		1	Set for line 12.	
2	LFC10	0	Do not set for line 11.	
		1	Set for line 11.	
1	LFC9	0	Do not set for line 10.	
		1	Set for line 10.	
0	LFC8	0	Do not set for line 9.	
		1	Set for line 9.	

*: This resistor is set to the all bits zero state when the IC is reset by the $\overline{\text{RST}}$ pin.

LC74736PT

65 COMMAND63 (Border control D line main 1 setting command)

(1) First byte

DA0 to 7	Register	Content		Notes
		State	Function	
7	-	1	Command 6 identification code Border line setting D main 1 control	
6	-	1		
5	-	1		
4	-	0		
3	-	0	Extended command 3 identification code	
2	-	0		
1	-	1		
0	-	1		

(2) Second byte

DA0 to 7	Register	Content		Notes
		State	Function	
7	-	0		Border control line settings control main 1 Lower lines
6	-	0		
5	-	0		
4	-	0		
3	-	0		
2	-	0		
1	LFC17	0	Do not set for line 18.	
		1	Set for line 18.	
0	LFC16	0	Do not set for line 17.	
		1	Set for line 17.	

*: This resistor is set to the all bits zero state when the IC is reset by the $\overline{\text{RST}}$ pin.

LC74736PT

66 COMMAND64 (Border control U line main 2 setting command)

(1) First byte

DA0 to 7	Register	Content		Notes
		State	Function	
7	-	1	Command 6 identification code	
6	-	1	Border line setting U main 2 control	
5	-	1		
4	-	0		
3	-	0	Extended command 4 identification code	
2	-	1		
1	-	0		
0	-	0		

(2) Second byte

DA0 to 7	Register	Content		Notes
		State	Function	
7	LFC7	0	Do not set for line 8.	Border control line settings control main 2 Upper lines
		1	Set for line 8.	
6	LFC6	0	Do not set for line 7.	
		1	Set for line 7.	
5	LFC5	0	Do not set for line 6.	
		1	Set for line 6.	
4	LFC4	0	Do not set for line 5.	
		1	Set for line 5.	
3	LFC3	0	Do not set for line 4.	
		1	Set for line 4.	
2	LFC2	0	Do not set for line 3.	
		1	Set for line 3.	
1	LFC1	0	Do not set for line 2.	
		1	Set for line 2.	
0	LFC0	0	Do not set for line 1.	
		1	Set for line 1.	

*: This resistor is set to the all bits zero state when the IC is reset by the $\overline{\text{RST}}$ pin.

LC74736PT

67 COMMAND65 (Border control D line main 2 setting command)

(1) First byte

DA0 to 7	Register	Content		Notes
		State	Function	
7	-	1	Command 6 identification code	
6	-	1	Border line setting D main 2 control	
5	-	1		
4	-	0		
3	-	0	Extended command 5 identification code	
2	-	1		
1	-	0		
0	-	1		

(2) Second byte

DA0 to 7	Register	Content		Notes
		State	Function	
7	LFC15	0	Do not set for line 16.	Border control line settings control main 2 Lower lines
		1	Set for line 16.	
6	LFC14	0	Do not set for line 15.	
		1	Set for line 15.	
5	LFC13	0	Do not set for line 14.	
		1	Set for line 14.	
4	LFC12	0	Do not set for line 13.	
		1	Set for line 13.	
3	LFC11	0	Do not set for line 12.	
		1	Set for line 12.	
2	LFC10	0	Do not set for line 11.	
		1	Set for line 11.	
1	LFC9	0	Do not set for line 10.	
		1	Set for line 10.	
0	LFC8	0	Do not set for line 9.	
		1	Set for line 9.	

*: This resistor is set to the all bits zero state when the IC is reset by the $\overline{\text{RST}}$ pin.

LC74736PT

68 COMMAND66 (Border control D line main 2 setting command)

(1) First byte

DA0 to 7	Register	Content		Notes
		State	Function	
7	-	1	Command 6 identification code Border line setting D main 2 control	
6	-	1		
5	-	1		
4	-	0		
3	-	0	Extended command 6 identification code	
2	-	1		
1	-	1		
0	-	0		

(2) Second byte

DA0 to 7	Register	Content		Notes
		State	Function	
7	-	0		Border control line settings control main 2 Lower lines
6	-	0		
5	-	0		
4	-	0		
3	-	0		
2	-	0		
1	LFC17	0	Do not set for line 18.	
		1	Set for line 18.	
0	LFC16	0	Do not set for line 17.	
		1	Set for line 17.	

*: This resistor is set to the all bits zero state when the IC is reset by the $\overline{\text{RST}}$ pin.

LC74736PT

69 COMMAND67 (PLL control 1 setting command)

(1) First byte

DA0 to 7	Register	Content		Notes
		State	Function	
7	-	1	Command 6 identification code PLL control 1	
6	-	1		
5	-	1		
4	-	0		
3	-	0	Extended command 7 identification code	
2	-	1		
1	-	1		
0	-	1		

(2) Second byte

DA0 to 7	Register	Content		Notes
		State	Function	
7	EVO OFF	0	External VCO on	Oscillator-related control Initial LC oscillation
		1	External VCO off	
6	LC OFF	0	LC oscillator on	
		1	LC oscillator off	
5	ECK OFF	0	External clock on	
		1	External clock off	
4	VCO OFF	0	VCO oscillator on	
		1	VCO oscillator off	
3	VCO SL1	0	VCOSL1 0	VCO selection Clock selection required CKSL = 10
		1	0 0 Internal VCO 1/1	
2	VCO SL0	0	0 1 Internal VCO 1/2	
		1	1 0 Internal VCO 1/4	
1	CKSL 1	0	CKSL1 0	Clock selection
		1	0 0 LC	
0	CKSL 0	0	0 1 External clock	
		1	1 0 Internal VCO (PLL) or external VCO	

*: This resistor is set to the all bits zero state when the IC is reset by the RST pin.

LC74736PT

70 COMMAND68 (PLL control 2 setting command)

(1) First byte

DA0 to 7	Register	Content		Notes
		State	Function	
7	-	1	Command 6 identification code PLL control 2	
6	-	1		
5	-	1		
4	-	0		
3	-	1	Extended command 8 identification code	
2	-	0		
1	-	0		
0	-	0		

(2) Second byte

DA0 to 7	Register	Content		Notes
		State	Function	
7	-	0		PLL-circuit frequency division ratio setting
6	-	0		
5	-	0		
4	DIV 12	0		
		1		
3	DIV 11	0		
		1		
2	DIV 10	0		
		1		
1	DIV 9	0		
		1		
		1		
0	DIV 8	0		
		1		

*: This resistor is set to the all bits zero state when the IC is reset by the $\overline{\text{RST}}$ pin.

LC74736PT

71 COMMAND69 (PLL control 3 setting command)

(1) First byte

DA0 to 7	Register	Content		Notes
		State	Function	
7	-	1	Command 6 identification code PLL control 3	
6	-	1		
5	-	1		
4	-	0		
3	-	1	Extended command 9 identification code	
2	-	0		
1	-	0		
0	-	1		

(2) Second byte

DA0 to 7	Register	Content		Notes
		State	Function	
7	DIV 7	0	$N2 = \sum_{n=0}^{12} 2^n \text{DIV}_n$ N2: 48 to 8196 30 to 1FFF (hexadecimal) FVCO = fH × N2 VCO oscillation frequency Horizontal frequency input	PLL-circuit frequency division ratio setting Initial values: 27BHEX fH = 15.734kHz FVCO = 10MHz
		1		
6	DIV 6	0		
		1		
5	DIV 5	0		
		1		
4	DIV 4	0		
		1		
3	DIV 3	0		
		1		
2	DIV 2	0		
		1		
1	DIV 1	0		
		1		
0	DIV 0	0		
		1		

*: This resistor is set to the all bits zero state when the IC is reset by the $\overline{\text{RST}}$ pin.

LC74736PT

72 COMMAND6A (PLL control 5 setting command)

(1) First byte

DA0 to 7	Register	Content		Notes
		State	Function	
7	-	1	Command 6 identification code PLL control 5	
6	-	1		
5	-	1		
4	-	0		
3	-	1	Extended command A identification code	
2	-	0		
1	-	1		
0	-	0		

(2) Second byte

DA0 to 7	Register	Content		Notes
		State	Function	
7	-	0		
6	HD SEL	0	HD (AFC)	H sync signal switch at AFC Enabled when Com67-2 CKSL is set to 10.
		1	HIN (input)	
5	DZ1	0	DZ1 DZ0	Dead zone specification
		1	0 0 DZA 0.0ns	
4	DZ0	0	0 1 DZB 0.5ns	
		1	1 0 DZC 2.5ns	
3	HREF SL	0	HREF (sync)	HREF selection
		1	HREF (directly)	
2	DID 2	0	DID2 1 0 Frequency division ratio (N1)	Dot clock frequency division ratio specification
		1	0 0 0 1/1	
1	DID 1	0	0 0 1 1/2	
		1	0 1 0 1/3	
0	DID 0	0	0 1 1 1/4	
		1	1 0 0 1/6 FDOT = FVCO×N1 Dot clock VCO oscillation frequency	

*: This resistor is set to the all bits zero state when the IC is reset by the RST pin.

LC74736PT

73 COMMAND6C0 (Color table write address setting command)

(1) First byte

DA0 to 7	Register	Content		Notes
		State	Function	
7	-	1	Command 6 identification code Color table write address setting	
6	-	1		
5	-	1		
4	-	0		
3	-	1	Sub-identifier code CO	
2	-	1		
1	-	0		
0	-	0		

(2) Second byte

DA0 to 7	Register	Content		Notes
		State	Function	
7	-			
6	-			
5	CTN1	0	CTN1 CTN0	Color table selection
		1	0 0 Color table number 1	
4	CTN0	0	0 1 Color table number 2	
		1	1 0 Color table number 3	
3	CTA3 (MSB)	0	Color table address 0 to 15 0 to F (hexadecimal) 16 values	Address of the color tables
		1		
2	CTA2	0		
		1		
1	CTA1	0		
		1		
0	CTA0 (LSB)	0		
		1		

*: This resistor is set to the all bits zero state when the IC is reset by the $\overline{\text{RST}}$ pin.

LC74736PT

74 COMMAND6C1 (Color table data write setting command)

(1) First byte

DA0 to 7	Register	Content		Notes
		State	Function	
7	-	1	Command 6 identification code Color table write setting	When this command has been issued, the IC remains in display character data write mode until the \overline{CS} pin is set high.
6	-	1		
5	-	1		
4	-	0		
3	-	1	Sub-identifier code C1	
2	-	1		
1	-	1		
0	RM3	0	RM3 Mode	Continuous write mode selection
		1	0 [1][2] End 1 [1][2] Continuous	

(2) Second byte-[1]

DA0 to 7	Register	Content		Notes
		State	Function	
7	-	0		
6	-	0		
5	HFT	0	Halftone: off	
		1	Halftone: on (HFTOT output is high.)	
4	TOK	0	Color	
		1	Transparent (BLK output: low)	
3	TB3	0	Color table B output 0000 to 1111 0 to F (hexadecimal)	Color table setting B
		1		
2	TB2	0		
		1		
1	TB1	0		
		1		
0	TB0	0		
		1		

*: This resistor is set to the all bits zero state when the IC is reset by the \overline{RST} pin.

LC74736PT

(3) Second byte-[2]

DA0 to 7	Register	Content		Notes		
		State	Function			
7	TG3	0	Color table G output 0000 to 1111 0 to F (hexadecimal)	Color table setting G		
		1				
6	TG2	0				
		1				
5	TG1	0				
		1				
4	TG0	0				
		1				
3	TR3	0			Color table R output 0000 to 1111 0 to F (hexadecimal)	Color table setting R
		1				
2	TR2	0				
		1				
1	TR1	0				
		1				
0	TR0	0				
		1				

*: This resistor is set to the all bits zero state when the IC is reset by the $\overline{\text{RST}}$ pin.

When transparent is selected, the BLK output is set to the low level. (Transparent state)

The RGB outputs are values from the color table.

The transparent specification is best for color table 1, address 0000.

Since the data is set to all zeros by a RAM clear operation,

the RGB output will be 000 (black) and the BLK output will be 1.

Transparent is specified by setting the TOK bit to 1. (The BLK output will go to the low level.)

LC74736PT

75 COMMAND700 (Character RAM write address setting command)

(1) First byte

DA0 to 7	Register	Content		Notes
		State	Function	
7	-	1	Command 7 identification code	
6	-	1	Character RAM write address setting	
5	-	1		
4	-	1		
3	-	0	Sub-identifier code 000	
2	-	0		
1	-	0		
0	-	0		

(2) Second byte

DA0 to 7	Register	Content		Notes
		State	Function	
7	FAD1	0	QVGA mode	Character RAM QVGA: address WVGA: PNo.
		1	Character RAM address 0 to 3	
6	FAD0	0	0 to 3 (hexadecimal)	
		1	WVGA mode PNo. 0 to 3 P1 to P4	
5	FRN1	0	ROM No.1 to 4	Character RAM ROM No.
		1	0 to 3 0 to 3 (hexadecimal)	
4	FRN0	0	No.1 to No.4	
		1		
3	FVA3 (MSB)	0	Character RAM V dot addresses	Character RAM V dot address
		1	0 to 15 0 to F (hexadecimal)	
2	FVA2	0		
		1		
1	FVA1	0		
		1		
0	FVA0 (LSB)	0		
		1		

*: This resistor is set to the all bits zero state when the IC is reset by the $\overline{\text{RST}}$ pin.

LC74736PT

76 COMMAND701 (Character RAM data write setting command)

(1) First byte

DA0 to 7	Register	Content		Notes
		State	Function	
7	-	1	Command 7 identification code Character RAM data write address setting	When this command has been issued, the IC remains in display character data write mode until the \overline{CS} pin is set high.
6	-	1		
5	-	1		
4	-	1		
3	-	0	Sub-identifier code 001	
2	-	0		
1	-	1		
0	RM3	0		
		1		

(2) Second byte-[1]

DA0 to 7	Register	Content		Notes
		State	Function	
7	D15	0	Character RAM write data D15 to D0	Character RAM write data
		1		
6	D14	0		
		1		
5	D13	0		
		1		
4	D12	0		
		1		
3	D11	0		
		1		
2	D10	0		
		1		
1	D9	0		
		1		
0	D8	0		
		1		

*: This resistor is set to the all bits zero state when the IC is reset by the \overline{RST} pin.

LC74736PT

(3) Second byte-[2]

DA0 to 7	Register	Content		Notes
		State	Function	
7	D7	0		Character RAM write data
		1		
6	D6	0		
		1		
5	D5	0		
		1		
4	D4	0		
		1		
3	D3	0		
		1		
2	D2	0		
		1		
1	D1	0		
		1		
0	D0	0		
		1		

*: This resistor is set to the all bits zero state when the IC is reset by the $\overline{\text{RST}}$ pin.

LC74736PT

77 COMMAND710 (WVGA: ROM access setting command)

(1) First byte

DA0 to 7	Register	Content		Notes
		State	Function	
7	-	1	Command 7 identification code WVGA ROM access setting	
6	-	1		
5	-	1		
4	-	1		
3	-	0	Sub-identifier code 0100	
2	-	1		
1	-	0		
0	-	0		

(2) Second byte

DA0 to 7	Register	Content		Notes
		State	Function	
7		0		
6		0		
5	CKOS1	0	CKOS1 0	CLKout output selection
		1	0 0 CLK	
4	CKOS0	0	0 1 PHASECP(HD1BFQ)	
		1	1 0 NCHCP	
3	WFCMD	0	No border	WVGA mode Specifies border display when ROM access mode is set to 011 or 100.
		1	Border (displayed for each upper and lower 1V)	
2	WRAM2	0	When WRAM210 DCLK=33.3MHz • No.1 3CLK = 90ns 000 Main 1 only (Main 2 display off) 001 Main 2 only (Main 1 display off) because box is displayed • No.2 2CLK 60ns Main 1 Main 2 010 Character Character 011 Graphic Character HPM1≤HPM2 * The character has no border. 100 Character Graphic HPM1≥HPM2 * The character has no border. • No.3 1CLK = 30ns 101 Equivalent to QVGA (external ROM only)	WVGA mode ROM access specification
		1		
1	WRAM1	0		
		1		
0	WRAM0	0		
		1		

*: This resistor is set to the all bits zero state when the IC is reset by the RST pin.

LC74736PT

78 COMMAND711 (PLL setting command 6)

(1) First byte

DA0 to 7	Register	Content		Notes
		State	Function	
7	-	1	Command 7 identification code PLL setting command 6	
6	-	1		
5	-	1		
4	-	1		
3	-	0	Sub-identifier code 0101	
2	-	1		
1	-	0		
0	-	1		

(2) Second byte

DA0 to 7	Register	Content		Notes
		State	Function	
7	RSETB	0	VCOR: Internal RSETB"H"	VCOR selection
		1	VCOR: External "L"	
6	-	0		
5	VCR S1	0	VCRS1 VCRS0 RSET0 1 2	Internal VCOR value setting Large resistance → low gain
		1	0 0 5.6K 1 1 0	
4	VCR S0	0	0 1 6.6K 1 0 0	
		1	1 0 7.6K 0 0 0	
3	CPI X2	0	The following set current ×1	CP current value setting 2
		1	The following set current ×3	
2	-	0		
1	CPI S1	0	CPIS1 CPIS0 CPIS0 1 2	CP current value setting 1
		1	0 0 40μA 0 0 0	
0	CPI S0	0	0 1 44μA 1 0 0	
		1	1 0 52μA 0 1 0	
			1 1 60μA 0 0 1	

*: This resistor is set to the all bits zero state when the IC is reset by the RST pin.

LC74736PT

79 COMMAND712 (PLL setting command 7)

(1) First byte

DA0 to 7	Register	Content		Notes
		State	Function	
7	-	1	Command 7 identification code	
6	-	1	Display character data write setting	
5	-	1		
4	-	1		
3	-	0	Sub-identifier code 0110	
2	-	1		
1	-	1		
0	-	0		

(2) Second byte

DA0 to 7	Register	Content		Notes
		State	Function	
7	-	0		
6	STYB CP	0	Normal operation: STYB"H"	CP, VCO standby setting
		1	CP, VCO standby: PD0 = "Z"	
5	RESETBCP	0	Normal operation: RESETB"H"	PD reset setting
		1	PD reset: PD0 = "Z"	
4	SCP1 CP	0	CP enable: SCP1"H"	CP control
		1	CP disable	
3	DIV ENB	0	Normal operation: DIVENB"H"	Frequency divider control
		1	Frequency divider reset	
2	GAIN 2	0	GAIN Fmin Fmax Gain[MHz]	VCO adjustment
		1	2 1 0	
1	GAIN 1	0	0 0 0 7 40 20V	
		1	0 0 1 7 -20% -22.5%	
0	GAIN 0	0	0 1 0 -20% 40 +2.5%	
			0 1 1 -20% -20% -20%	
		1	1 0 0 +20% +10% +8.75%	
			1 0 1 +20% -10% -13.75%	
		1 1 0 7 +10% +11.25%		
		1 1 1 7 -10% +11.25%		

*: This resistor is set to the all bits zero state when the IC is reset by the RST pin.

Operational Description

1. Command transfer method

1.1 Overview

(1) Commands are transferred in 8-bit units, LSB first.

Always send a first byte and a second byte (16 bits).

(2) COMMAND10 (Main screen 1 RAM write)

COMMAND11 (Main screen 2 RAM write)

COMMAND12 (Subscreen write)

COMMAD6C1 (Color table write)

COMMAND701 (Character RAM write) is locked in continuous write mode when a continuous mode is specified (RM2, 1 RM3). (Continuous mode is cleared by setting the CS pin high.)

1.2 Writing Data to VRAM

(1) Write start address specification

Write start address is set using:

COMMAND00, COMMAND01 (Main screen 1)

COMMAND02, COMMAND03 (Main screen 2)

COMMAND04 (Subscreen)

V4 to V0: Vertical direction; H5 to H0: Horizontal direction

(2) Data write

Continuous write mode differs depending on the write mode specification. (RM1, RM2)

1. Normal (RM2 = 0, RM1 = 0: initial state) *Continuous mode not used*

-- COM10-1 10-2-1 10-2-2 10-2-3 10-2-4 10-2-5 command wait state --

2. Write continuous (RM2 = 0, RM1 = 1): Mode 2

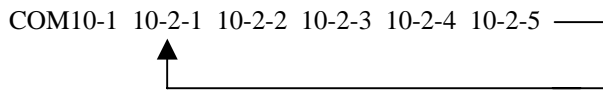

3. Write continuous (RM2 = 1, RM1 = 0): Mode 3

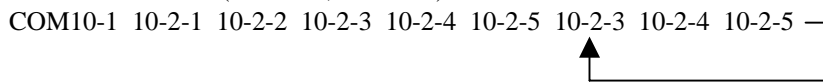

4. Write continuous (RM2 = 1, RM1 = 1): Mode 4

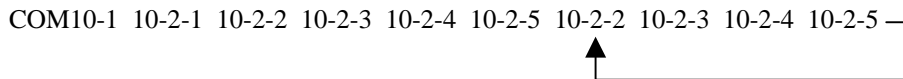

*: In modes 2, 3, and 4, the IC remains locked in continuous write mode until the $\overline{\text{CS}}$ pin is set high.

- The write address is automatically incremented.
- The write address is retained unless the IC is reset or a new write address is issued.

1.3 Color Table write

(1) Write start address specification

Use command 6C0 to set the color table write start address.

CTN1 to CTN0: Color table specification (No.1 to No.4), CTA3 to CTA0: Address specification

	No.1	B	G	R
0 0 0 0	XX	XXXX	XXXX	XXXX
0 0 0 1				
0 0 1 0				
Address				
1 1 1 0				
1 1 1 1				

(2) Data write

Continuous write mode differs depending on the write mode specification. (RM3)

1. Normal (RM3 = 0: initial state) *Continuous mode not used*

---COM6C1-1 6C1-2-1 6C1-2-2 command wait state ---

2. Write continuous (RM3 = 1) mode

COM6C1-1 6C1-2-1 6C1-2-2

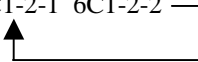

*: In mode 2, the IC remains locked in continuous write mode until the $\overline{\text{CS}}$ pin is set high.

- The write address is automatically incremented.
- The write address is retained unless the IC is reset or a new write address is issued.

LC74736PT

1.4 Character RAM write

(1) Write start address specification

Use COMMAND700 to specify the character RAM write start address.

FAD1 to FAD0: Character RAM address P-No specification

QVGA: 0 to 3, hexadecimal, (4 characters)

WVGA: 1 character only 0 to 3 (hexadecimal) P1 to P4

FVA3 to FVA0: Character RAM V dot address specification 0 to F (hexadecimal)

FRN1 to FRN0: ROM No. specification 0 to 3 (hexadecimal) No.1 to No.4

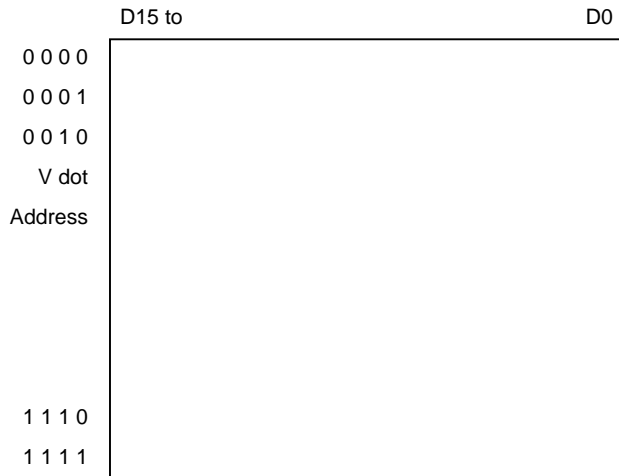

(2) Data write

Continuous write mode differs depending on the write mode specification. (RM3)

1. Normal (RM3 = 0: initial state) *Continuous mode not used*

---COM701-1 701-2-1 701-2-2 command wait state ---

2. Write continuous (RM3 = 1) mode

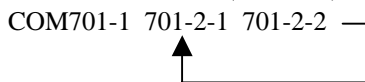

*: In mode 2, the IC remains locked in continuous write mode until the \overline{CS} pin is set high.

- The write address is automatically incremented.
- The write address is retained unless the IC is reset or a new write address is issued.

2. Display format

2.1 Color Specification Related Items

(1) When a character is specified

Specify color with the character color (character area) and character background color (outside the character area)

Character color: 1 of 16 colors

Character background color: 1 of 16 colors

Color tables: Table No. 1 to No. 4 specified by CT1 to CT0. (COM10-2-3: VRAM)

1 of 64 types

Character color

Specified by CC0 to CC3: 1 of 16 colors
(COM10-2-2: VRAM)

Character background color

Specified by CB0 to CB3: 1 of 16 colors
(COM10-2-2: VRAM)

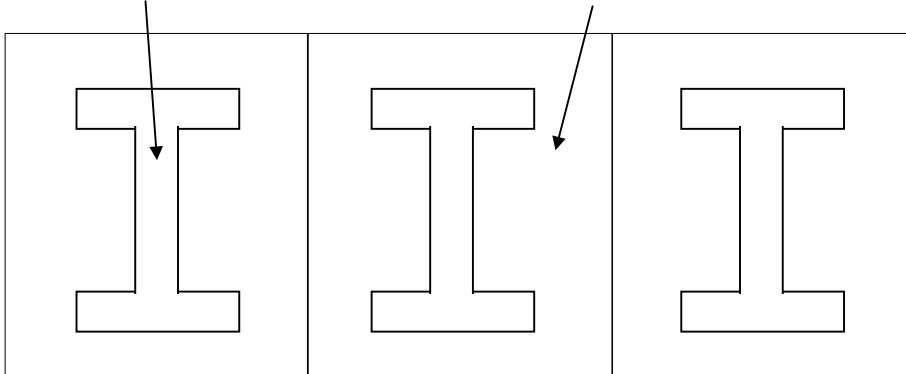

(2) When a graphic 1 is specified

Specify color is in dot units (16×16)

1 of 16 colors (FROM)

Color tables: Table No. 1 to No. 4 specified by CT1 to CT0. (COM10-2-3: VRAM)

1 of 64 types

Specified by FROM: 1 of 16 types

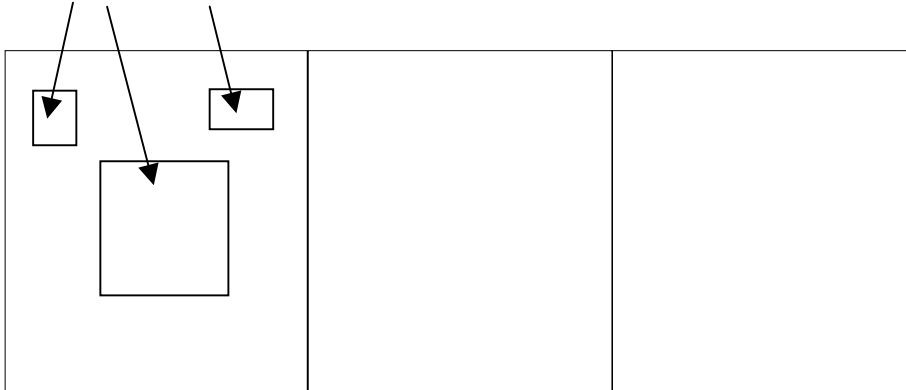

(3) When a graphic 2 is specified

Specify color is in dot units (16×16)

1 of 16 colors (FROM)

Color tables: Table No. 1 to No. 4 specified by CT1 to CT0. (COM10-2-3: VRAM)

1 of 64 types

The CTB address display color shown with CB3 to CB0 is changed to the CTB address display color shown with CC3 to CC0.

One color in the graphic character display can be changed by setting CB and CC.

Specified by FROM: 1 of 16 types

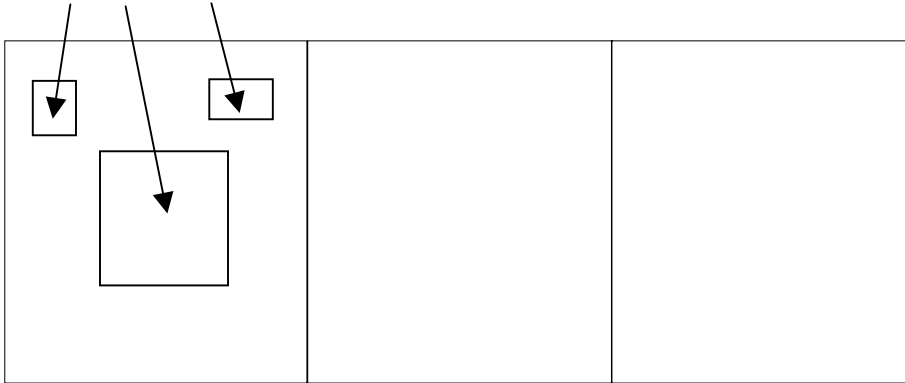

(4) When a graphic 3 is specified

Specify color is in dot units (16×16)

1 of 16 colors (FROM)

Color tables: Table No. 1 to No. 4 specified by CT1 to CT0. (COM10-2-3: VRAM)

1 of 64 types

CTB No. in the address shown with CB3 to CB0 is changed to CTB No. shown with CC1 to CC0 and display it.

CTB No. of one color in the graphic character display can be changed by setting CB and CC.

Specified by FROM: 1 of 16 types

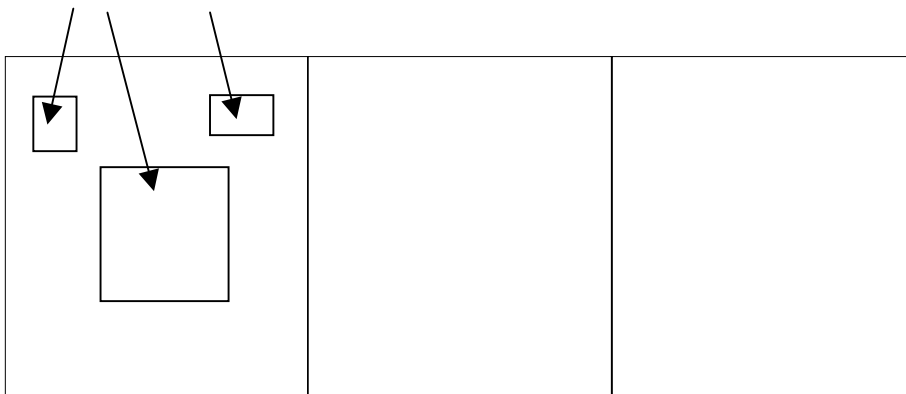

2.2 Display Control Related Items

(1) Blinking: In character units

- 1. Normal at1 = 0 (COM10-2-1: VRAM)

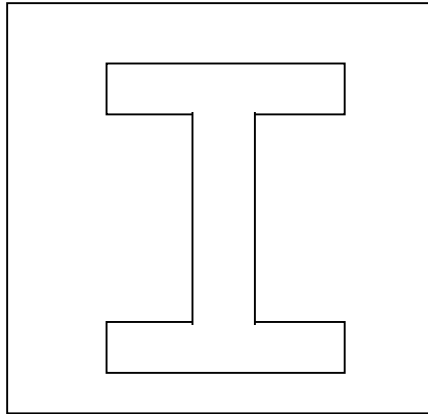

- 2. Blinking at1 = 1

Display alternates between normal and transparent with the blinking period. (COM21-2: BK1, BK0)

(2) Border display: Only valid for font specified characters

- 1. Border color: 1 of 16 colors (COM60-2 EGC3 to EGC0)

Color table specification (COM60-2 EGCT1 to EGCT0)

→ 1 of 64 types specified in line units

- 2. Border mode control (COM60-2 BLK1, BLK0) specified in line units

i. Border

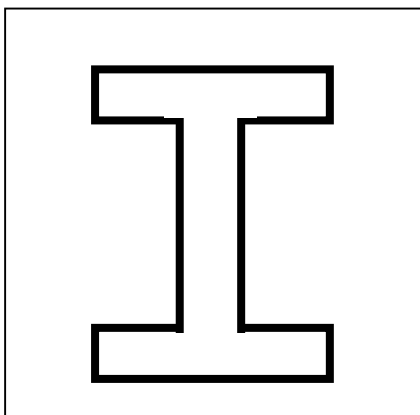

ii. Shadow 1: lower

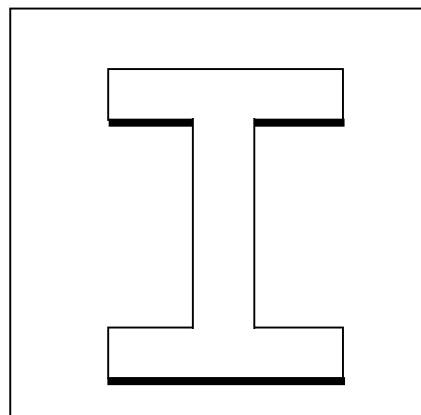

iii. Shadow 2: lower + right

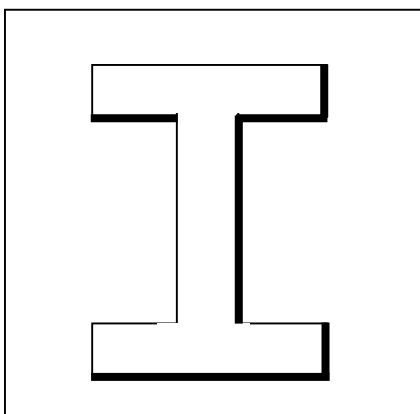

(3) Character size: Specified in line units

The character size is specified as 1x to 4x independently for the vertical and horizontal directions.
(COM40-2)

2.3 Box Display (raised/recessed)

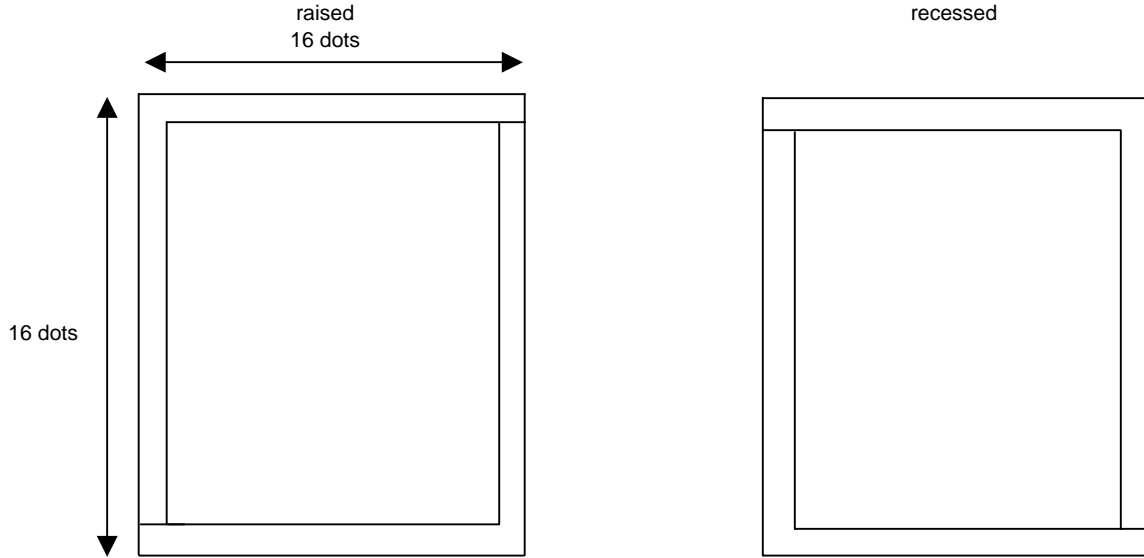

(1) Raised/recessed specification: In character units (COM10-2-1 BXS)

(2) Left side-displayed/undisplayed specification: in character units (COM10-2-1 BXL)

(3) Right side-displayed/undisplayed specification: in character units (COM10-2-1 BXR)

(4) Upper side-displayed/undisplayed specification: in character units (COM10-2-1 BXU)

(5) Lower side-displayed/undisplayed specification: in character units (COM10-2-1 BXD)

(6) Color specification: In line units

COM50 (Upper side)

COM51 (Lower side)

BXUC3 to BXDC0: 1 of 16 colors

BXDC3 to BXDC0: 1 of 16 colors

Color table specification

BXUCT1 to BXUCT0

BXDCT1 to BXUCT0

1 of 64 types

Box dot width specification

Each of left, right, upper, and lower can be specified independently.

Left: BXLW1 to BXLW0 1 to 4 dots

Right: BXRW1 to BXRW0 1 to 4 dots

Upper and lower (COM59-2)

Upper BXWU 1 to 2 dots (It depends on the character size.)

Lower BXWD 1 to 2 dots (It depends on the character size.)

LC74736PT

2.4 Line spacing control (Command 58-2: GY3, GY2, GY1, GY0)

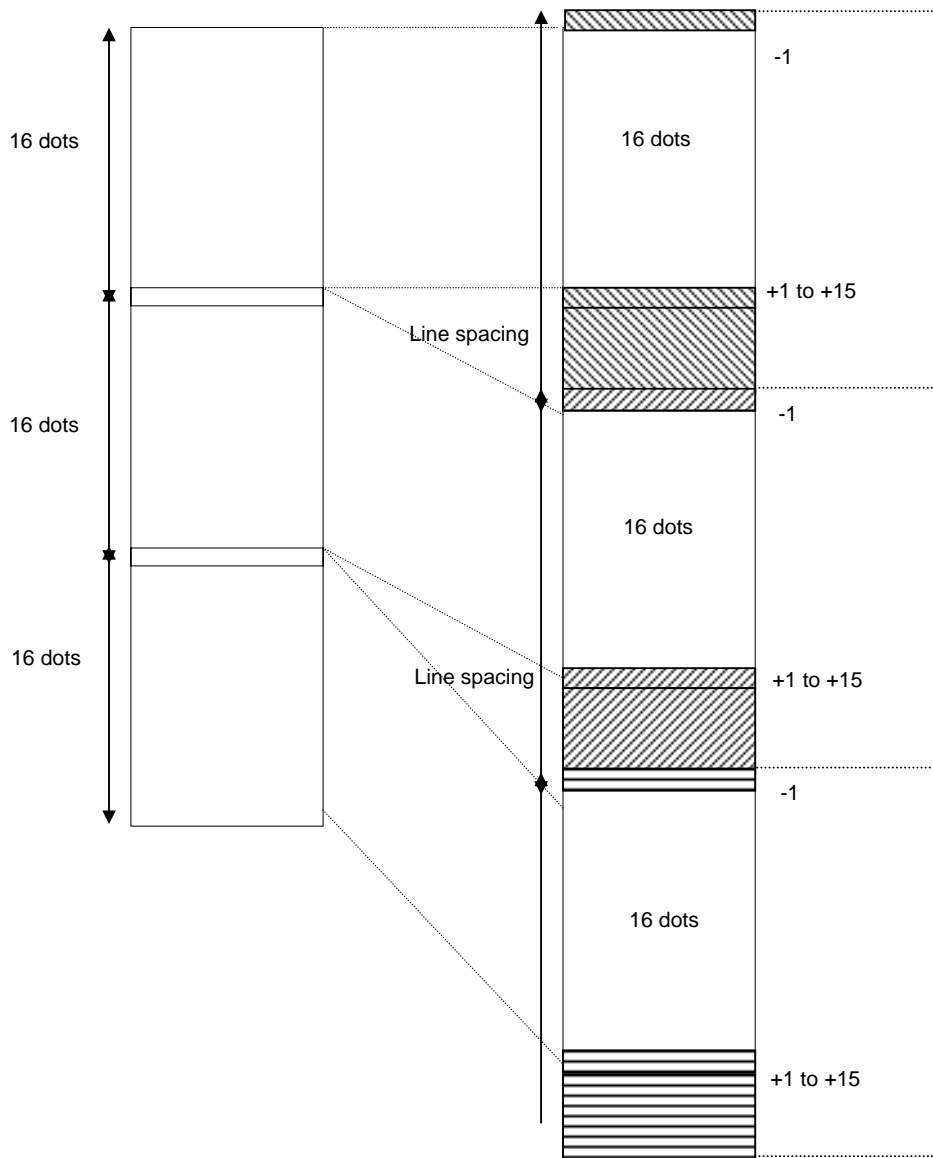

- Line spacing display control

COM58-2: GS1, GS0

	Character	Graphic
(1)	Transparent	Transparent
(2)	Transparent	Transparent
	± 1 (character background color)	± 1 (CB specified color)
(3)	Character background color	CB setting color
(4)	Transparent	Transparent
	(Border enabled)	

- Basic line spacing unit
GYBCK "0": 1V
"1": It depends on the character size.
- Box display (COM59-2)
Character display range

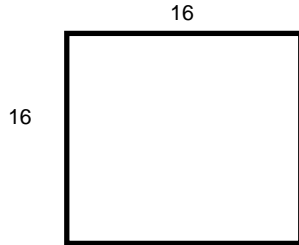

Box display

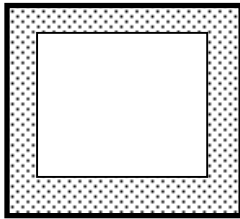

Inside the character

BXC1 = "0"
BXC2 = "0"

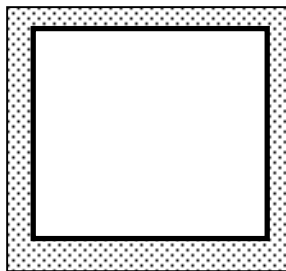

Outside the character 1
(Valid only when line spacing is set.)

BXC1 = "1"
BXC2 = "1"
BXC3 = "0"

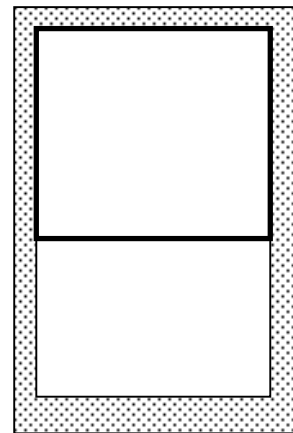

Outside the character 2
(Valid only when line spacing is set.)

BXC1 = "1"
BXC2 = "1"
BXC3 = "1"

2.5 Screen Structure

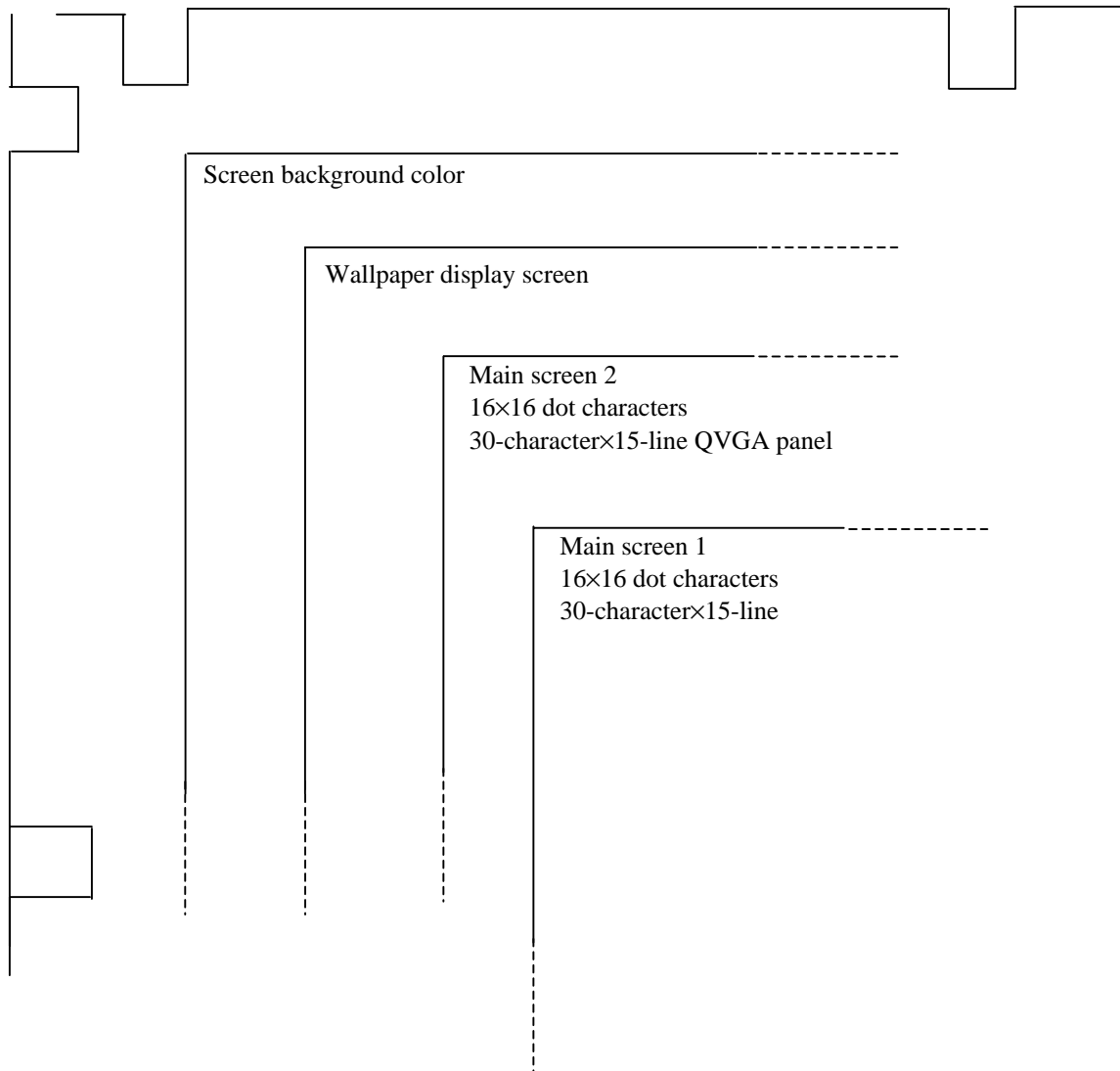

- For each screen: Display on/off (transparent) can be specified independently.
- For each screen: The display start position can be specified independently.
The wallpaper display screen and the main screen require xxxx clocks before the horizontal start position is reached.

- Display Format

- 1) QVGA

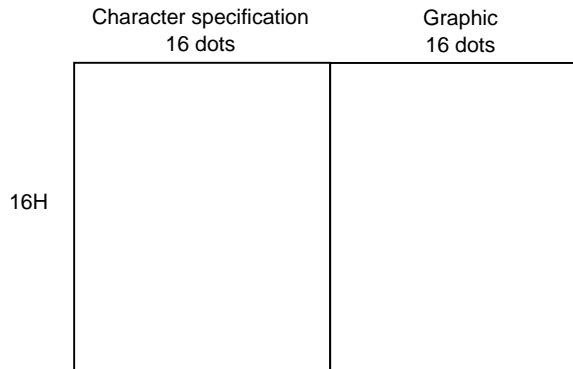

- 2) WVGA

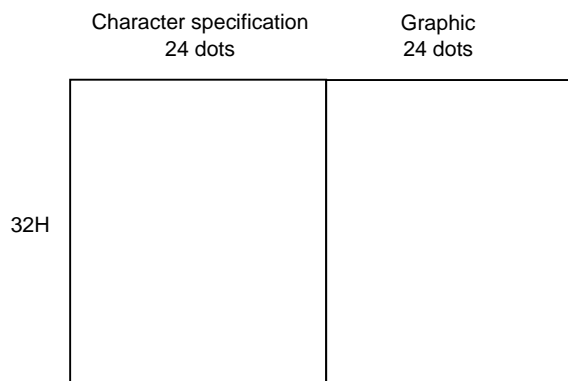

- ROM structure

- (1) No internal ROM

- (2) Internal character RAM QVGA: 4 characters, WVGA: 1 character

- 1) Character font

- QVGA: 16×16-dot structure

- WVGA: 24×32-dot structure

- 2) Graphics

- QVGA: 16×16-dot structure

- WVGA: 24×32-dot structure

LC74736PT

(3) External ROM (QVGA: 16384 characters, WVGA: 4096 characters)
 ×16 types, 16M

1) Conditions

- QVGA mode

Access time = 2× dot clock frequency or shorter

Example: DCLK = 10MHz = 100ns×2 = 200ns or shorter

- WVGA mode

1) Access time = 3× dot clock frequency or shorter, with display limitations

Example: DCLK = 33MHz = 30ns×3 = 90ns or shorter

2) Access time = 2× dot clock frequency or shorter, with display limitations

Example: DCLK = 33MHz = 30ns×2 = 60ns or shorter

3) Access time = 1× dot clock frequency or shorter

Example: DCLK = 33MHz = 30ns×1 = 30ns or shorter

2) ROM map

- QVGA

- Address

A19 to A0

- Data

D15 to D0

Used

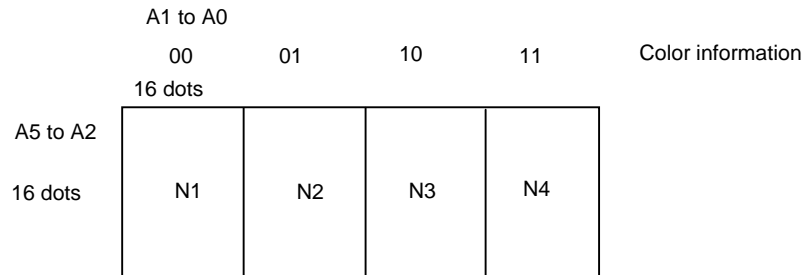

A19 to A6 (14 bits) = 16384 characters = character codes

LC74736PT

- WVGA

- Address
A19 to A0

- Data

- D15 to D12, D11 to D0
Unused Used

A3 to A2 Location information

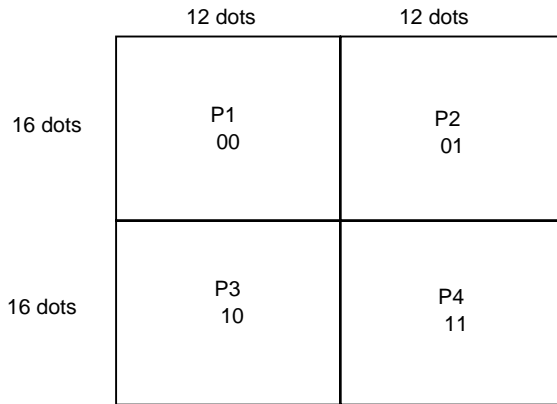

On each of P1 to P4

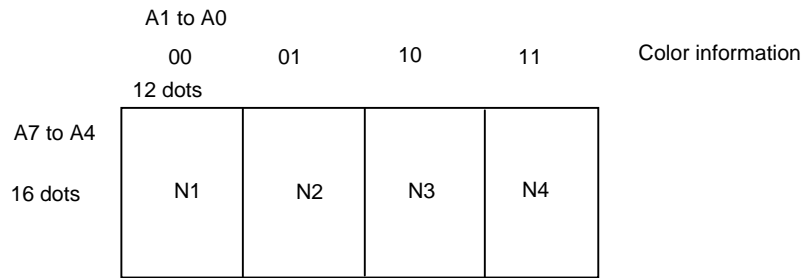

A19 to A8 (12 bits) = 4096 characters = character codes

3) Display appearance

- QVGA: 1 character = 16×16 dots
 Character N1 or N2 or N3 or N4, VRAM selectable
 Graphic N1+N2+N3+N4

Character

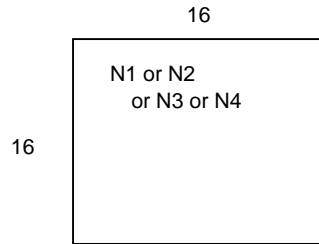

Graphic

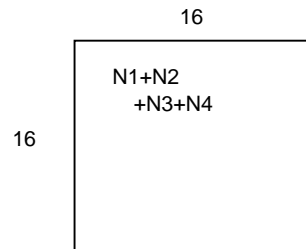

- WVGA: 1 character = 24×32 dots
 Character P1+P2+P3+P4 (12×16×4)
 N1 or N2 or N3 or N4, VRAM selectable
 Graphic P1+P2+P3+P4 (12×16×4)
 N1+N2+N3+N4

Character

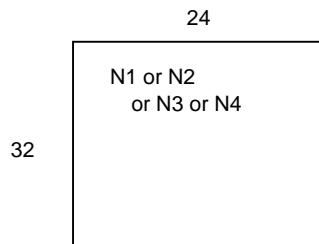

Graphic

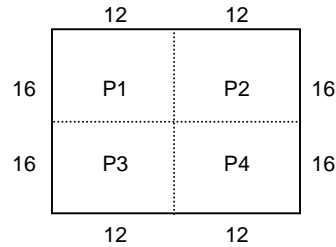
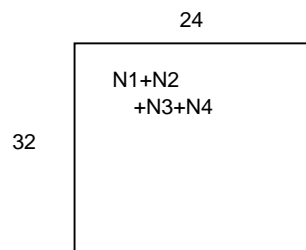

- SANYO Semiconductor Co.,Ltd. assumes no responsibility for equipment failures that result from using products at values that exceed, even momentarily, rated values (such as maximum ratings, operating condition ranges, or other parameters) listed in products specifications of any and all SANYO Semiconductor Co.,Ltd. products described or contained herein.
- SANYO Semiconductor Co.,Ltd. strives to supply high-quality high-reliability products, however, any and all semiconductor products fail or malfunction with some probability. It is possible that these probabilistic failures or malfunction could give rise to accidents or events that could endanger human lives, trouble that could give rise to smoke or fire, or accidents that could cause damage to other property. When designing equipment, adopt safety measures so that these kinds of accidents or events cannot occur. Such measures include but are not limited to protective circuits and error prevention circuits for safe design, redundant design, and structural design.
- In the event that any or all SANYO Semiconductor Co.,Ltd. products described or contained herein are controlled under any of applicable local export control laws and regulations, such products may require the export license from the authorities concerned in accordance with the above law.
- No part of this publication may be reproduced or transmitted in any form or by any means, electronic or mechanical, including photocopying and recording, or any information storage or retrieval system, or otherwise, without the prior written consent of SANYO Semiconductor Co.,Ltd.
- Any and all information described or contained herein are subject to change without notice due to product/technology improvement, etc. When designing equipment, refer to the "Delivery Specification" for the SANYO Semiconductor Co.,Ltd. product that you intend to use.
- Information (including circuit diagrams and circuit parameters) herein is for example only; it is not guaranteed for volume production.
- Upon using the technical information or products described herein, neither warranty nor license shall be granted with regard to intellectual property rights or any other rights of SANYO Semiconductor Co.,Ltd. or any third party. SANYO Semiconductor Co.,Ltd. shall not be liable for any claim or suits with regard to a third party's intellectual property rights which has resulted from the use of the technical information and products mentioned above.

This catalog provides information as of June, 2007. Specifications and information herein are subject to change without notice.