

Part Number	Description
DRD48A20	Dual 20A 510 Vac Output
DRD48D20	Dual 20A 510 Vac Output
DRD48R20	Dual 20A 510 Vac Output
DRD48D25	Dual 25A 510 Vac Output

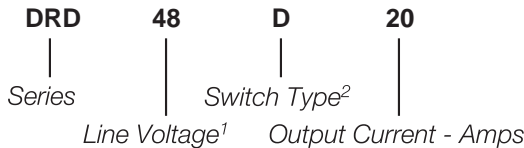

Part Number Explanation



NOTES

- 1) Line Voltage (nominal): 48 = 480 Vac
- 2) Switch Type: D = Zero-cross turn-on; R = Random turn-on;
A = Zero-cross, AC control

MECHANICAL SPECIFICATION

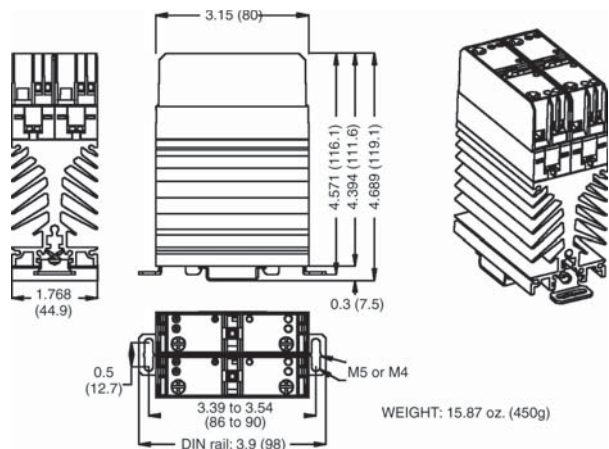

Figure 1 — DRD relay; dimensions in inches (mm)

TYPICAL APPLICATION

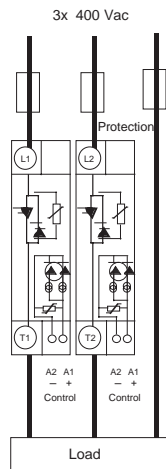

Figure 2 — DRD relay (See Note 4)

FEATURES/BENEFITS

- Mounting and dismounting on DIN rail without any tool or directly mountable on panel
- Zero-cross and random models; thyristor output
- Large control range with each input
- Green control LED
- Very high immunity
- Low leakage current
- Internal transient suppression

DESCRIPTION

The Series DRD dual-output DIN-rail relays are designed for all types of loads. The relays utilize optical isolation to protect the control from load transients. The DRD relays have an integral heat sink, and can be mounted and dismantled onto a DIN rail without any tools. The relays may also be panel mounted. All relays offer a green control LED and transient suppression. This dual package allows users to conserve cabinet space.

APPLICATIONS

- Heating control
- Motor control
- Industrial and process control

APPROVALS

Series DRD relays are pending UL recognition.

CONTROL CHARACTERISTIC

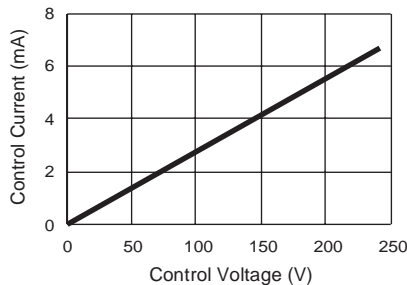

Figure 3a — DRD48A20 relay

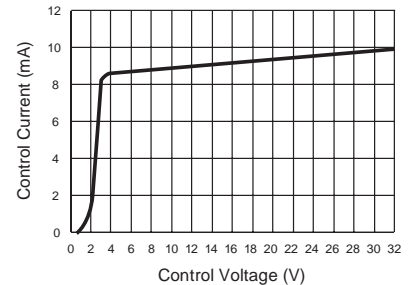

Figure 3b — DRD48D and DRD48R relays

INPUT (CONTROL) SPECIFICATION

	Min	Max	Units
Control Range			
DRD48A20	150	240	Vac/dc
All others	3.5	32	Vdc
Control Current Range			
DRD48A20	3	7	mA
All others	8.5	10	mAdc
Must Turn-Off Voltage			
DRD48A20	15		V
All others	2		V
Reverse Voltage (DC control)		32	V
Clamping Voltage (DC control)		42	V
Input LED		Green	

OUTPUT (LOAD) SPECIFICATION

	Min	Max	Unit
Operating Range	24	510	Vrms
Peak Voltage		1200	Vpeak
Clamping Voltage (@ 1mA)		820	V
Load Current Range (See Figure 4)			
DRD48D25	.005	25	Arms
All others	.005	20	Arms
Zero-Cross Window		±20	V
Non-Repetitive Overload Current (See Figure 5)			
DRD48D25		1000	A
All others		550	A
On-State Voltage Drop		0.9	V
Output Power Dissipation			
(Typical): each phase	$0.8xI+0.08xI^2$		W
Thermal Resistance Junction to Air			
DRD48D25		2.1	°C/W
All others		2.2	°C/W
Off-State Leakage Current (60Hz)		1	mA
Turn-On Time (60Hz)			
DRD48DXX		8.3	ms
DRD48RXX		0.1	ms
DRD48AXX		25	ms
Turn-Off Time (60Hz)			
DRD48AXX		25	ms
All others		8.3	ms

THERMAL CHARACTERISTICS

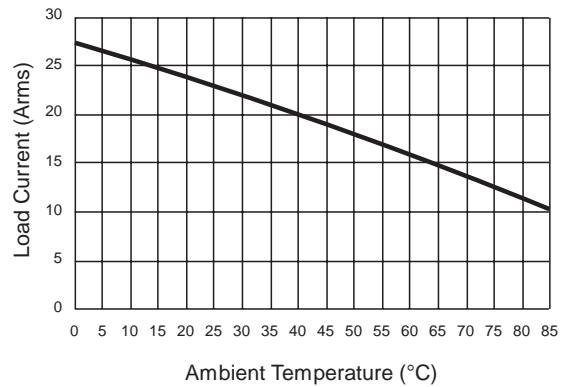

Figure 4a — DRD48X20

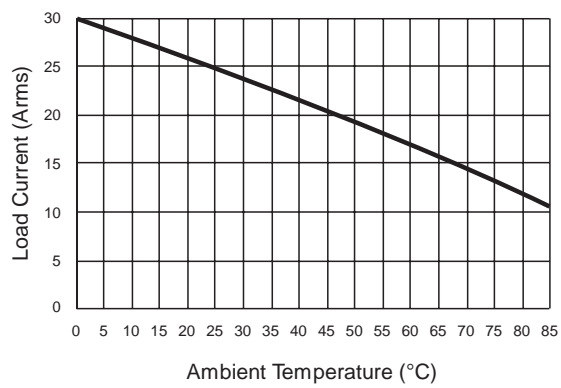

Figure 4b — DRD48D25

SURGE CURRENTS

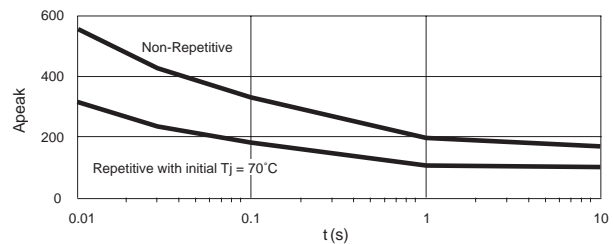

Figure 5a — DRD48X20

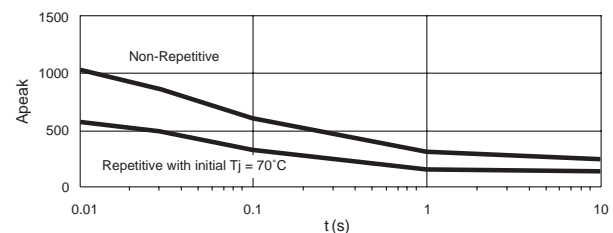

Figure 5b — DRD48D25

OUTPUT (LOAD) SPECIFICATION (Continued)

	Min	Max	Unit
Operating Frequency Range	0.1	440	Hz
Off-State dv/dt		500	V/ μ s
I^2t for match fusing (<8.3ms)			
DRD48D25		5000	A ² S
All others		1500	A ² S

ENVIRONMENTAL SPECIFICATION

	Min	Max	Unit
Storage Temperature	-30	100	°C
Operating Temperature	-30	80	°C
Input-Output Isolation	4000		Vrms
Output-Case Isolation	4000		Vrms
Insulation Resistance	100		M Ω
Rated Impulse Voltage	4000		V

DIN-RAIL MOUNTING

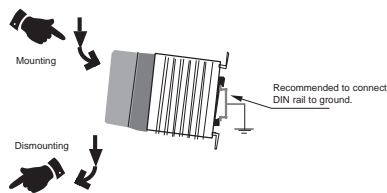

Figure 6 — DRD relay

PANEL MOUNTING

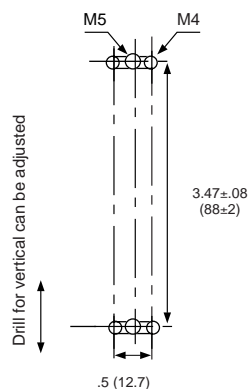
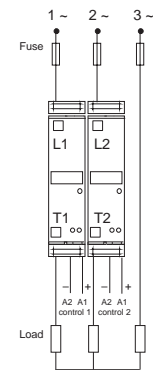
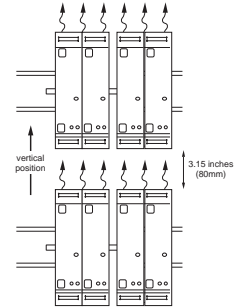

Figure 7 — DRD relay

NOTES:

- Connections: For output terminals, the wire cross sections must be adapted to the load current and to the overcurrent protection device characteristics. The relay rated voltage must be adapted to the mains rated voltage. These relays use screw clamp connections.
- Mounting: Should be in the vertical position. Protect heat-sensitive materials as well as people from contact with the heat sink. For non-vertical mounting, the load current must be 50% derated. The SSR needs air convection through the heat sink. Lack of air convection produces abnormal heating. Keep a distance between the upper SSR and the lower SSR (see figure on the right). In case of zero space between two SSRs, reduce the load current. It's suggested to keep the heat sink temperature under 90°C. Forced cooling significantly improves the thermal performance.
- Typical application loads: The DRD relay is designed for resistive and motor loads. For other loads, check the inrush current at turn-ON and possible overvoltages at turn-OFF or contact factory.
- Protection: To protect the SSR against a short-circuit of the load, use a fuse with a I^2t value = 1/2 I^2t value.
- EMC:
 - Immunity:** Immunity levels of the DRD comply with EN61000-4-4 & 5.
 - Emission:** The system integrator must ensure that systems containing SSRs comply with the requirements of any rules and regulations applicable at the system level. The very low zero-cross voltage (<20V) improves the conducted emission level in comparison with most SSRs with zero-cross voltage higher than 50V.
- All electrical parameters specified at 25°C unless otherwise noted.



CONNECTIONS

wires (mm ²)	torques	screwdriver
control 1 x (0.75-->2.5) L = 6mm	0.4N.m (0.6N.m max)	3.5 x 0.5mm
Power 1 x (1.5-->16) 1 x (1.5-->10) L = 10mm	1.2N.m (1.8N.m max)	Pozidriv2/ 0.8 x 5.5 (1 x 6)

Figure 8 — DRD relay