

Bidirectional DIAC Trigger Diode

Features

- Low breakover current
- Excellent symmetry
- Very low leakage current
- Trigger diode with a fixed voltage reference
- High temperature soldering guaranteed:
250°C/10s/9.5mm lead length at 5 lbs tension
- RoHS Compliance



DO-35



Mechanical Data

Case:	Glass Case DO-35
Terminals:	Plated axial leads, solderable per MIL-STD-750, method 2026
Weight:	Approx. 0.13 gram

Maximum Ratings and Electrical Characteristics ($T_A=25^\circ\text{C}$ unless noted otherwise)

Symbol	Description	Value			Unit	Conditions
		Min.	Typ.	Max.		
V_{BO}	Breakover Voltage*	28	32	36	V	$I_{BO}, C=22\text{nF}^{**}$
$ +V_{BO} - -V_{BO} $	Breakover Voltage Symmetry	-3	-	3	V	$I_{BO}, C=22\text{nF}^{**}$
$ \pm\Delta V $	Dynamic Breakover Voltage**	5	-	-	V	V_{BO} and V_F at 10mA
V_O	Output Voltage*	5	-	-	V	See Fig.6 (R=20Ω)
I_{BO}	Breakover Current*	-	-	100	μA	$C=22\text{nF}^{**}$
T_r	Rise Time*	-	-	2	μs	See Fig.5
I_B	Leakage Current*	-	-	10	μA	$V_B=0.5V_{BO}$ Max.
I_P	Peak Current*	0.3	-	-	A	See Fig.6 (Gate)
P_d	Power Dissipation on Printed Circuit	-	-	150	mW	$T_a=50^\circ\text{C}$
I_{TRM}	Repetitive Peak on-state Current	-	-	2	A	$t_p=20\mu\text{s}, f=100\text{Hz}$
R_{thJA}	Typical Thermal Resistance	-	-	400	°C / W	
R_{thJL}		-	-	150	°C / W	

Bidirectional DIAC Trigger Diode

DB3

Symbol	Description	Value	Unit	Conditions
T _J	Operating Temperature range	-40 to + 110	°C	
T _{STG}	Storage Temperature Range	-40 to + 125		

*Electrical characteristic applicable in forward and reverse directions.

**Connected in parallel with the devices.

Typical Characteristics Curves

Fig.1-Max. Power Dissipation

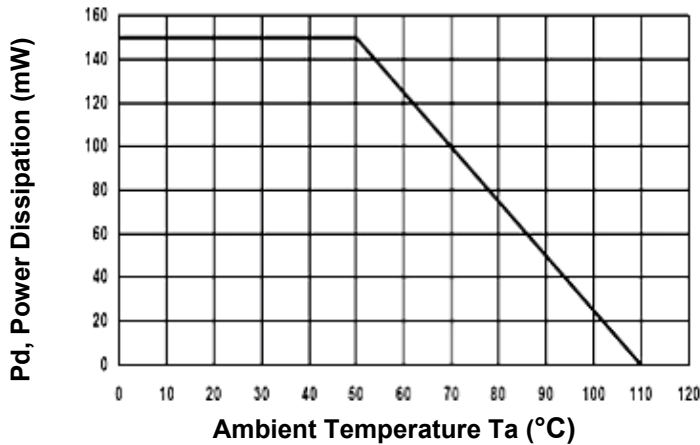

Fig.2- Typical Relative Variation of VBO

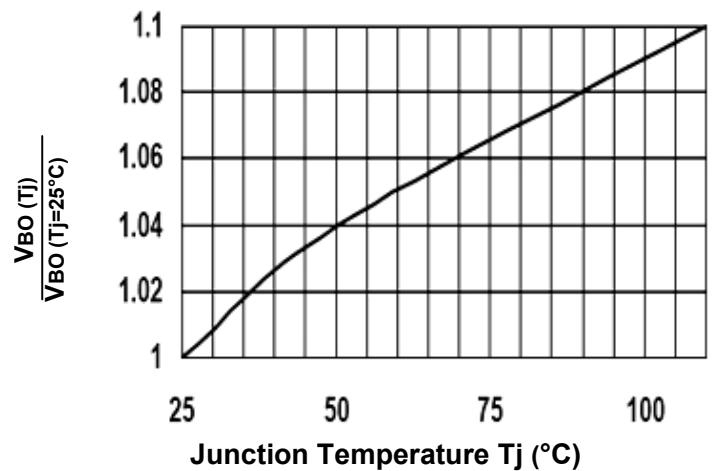

Fig.3- Peak Pulse Current

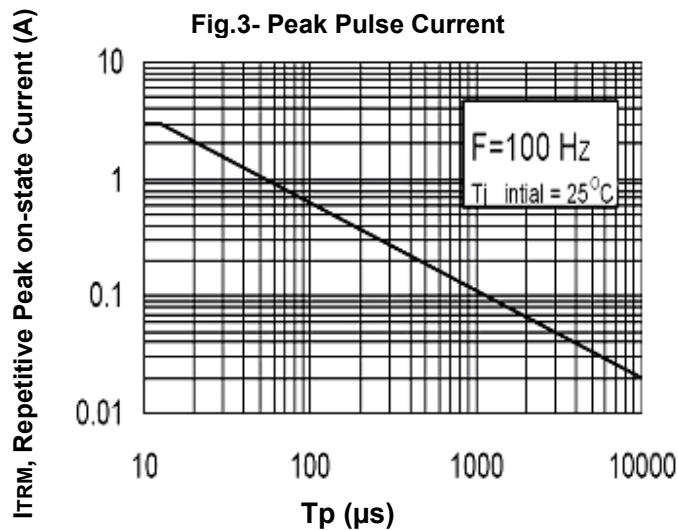

Fig.4-Voltage – Current characteristic Curve

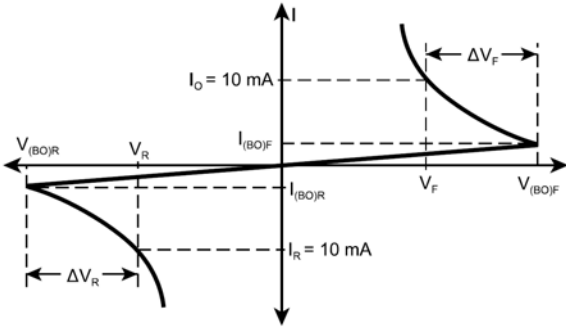

Fig.5- Rise Time Measurement

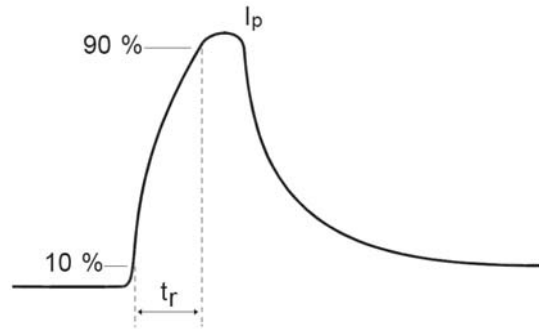
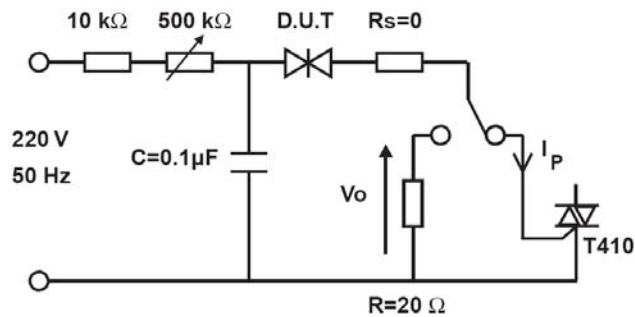

Fig.6-Test Circuit for Output Voltage



Bidirectional DIAC Trigger Diode

DB3

Dimensions in inches (mm)

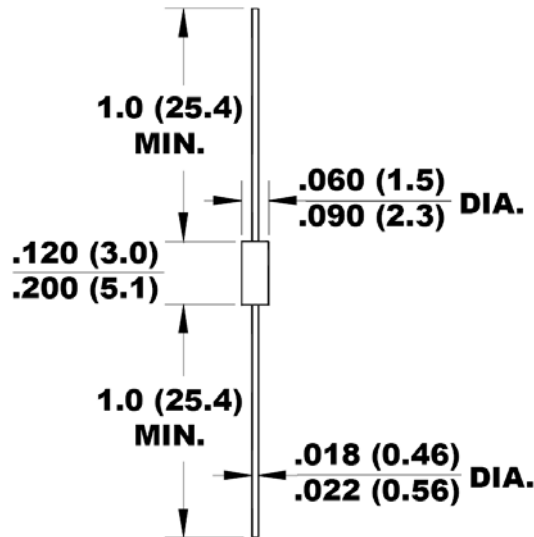

DO-35

How to contact us:

US HEADQUARTERS

28040 WEST HARRISON PARKWAY, VALENCIA, CA 91355-4162

Tel: (800) TAITRON (800) 824-8766 (661) 257-6060

Fax: (800) TAITFAX (800) 824-8329 (661) 257-6415

Email: taitron@taitroncomponents.com

Http://www.taitroncomponents.com

TAITRON COMPONENTS MEXICO, S.A .DE C.V.

BOULEVARD CENTRAL 5000 INTERIOR 5 PARQUE INDUSTRIAL ATITALAQUIA, HIDALGO C.P.

42970 MEXICO

Tel: +52-55-5560-1519

Fax: +52-55-5560-2190

TAITRON COMPONETS INCORPORATED E REPRESENTAÇÕES DO BRASIL LTDA

RUA DOMINGOS DE MORAIS, 2777, 2.ANDAR, SALA 24 SAÚDE - SÃO PAULO-SP 04035-001 BRAZIL

Tel: +55-11-5574-7949

Fax: +55-11-5572-0052

TAITRON COMPONETS INCORPORATED, SHANGHAI REPRESENTATIVE OFFICE

CROSS REGION PLAZA, 899 LINLING ROAD, SUITE 18C, SHANGHAI, 200030, CHINA

Tel: +86-21-5424-9942

Fax: +86-21-5424-9931