



Technical Data Sheet

5mm Infrared LED, T-1 3/4

HIR333C/H0

Features

- High reliability
- High radiant intensity
- Peak wavelength $\lambda_p=850\text{nm}$
- 2.54mm Lead spacing
- Low forward voltage
- Pb free
- The product itself will remain within RoHS compliant version.

Descriptions

- EVERLIGHT'S Infrared Emitting Diode(HIR333C/H0) is a high intensity diode , molded in a water clear plastic package.
- The device is spectrally matched with phototransistor , photodiode and infrared receiver module.

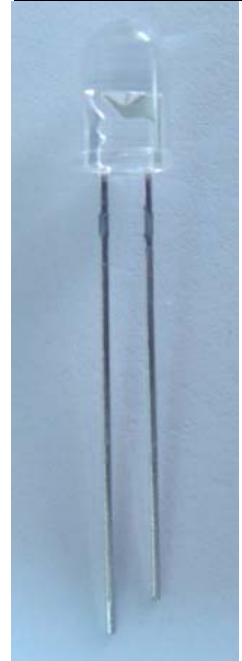

Applications

- Free air transmission system
- Optoelectronic switch
- Floppy disk drive
- Infrared applied system
- Smoke detector

Device Selection Guide

LED Part No.	Chip	Lens Color
	Material	
HIR	GaAlAs	Water clear

Package Dimensions

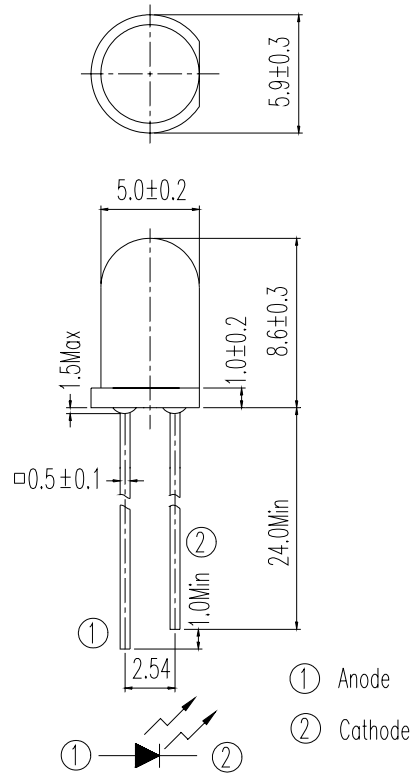

- Notes:** 1.All dimensions are in millimeters
 2.Tolerances unless dimensions ± 0.25 mm

Absolute Maximum Ratings (Ta=25°C)

Parameter	Symbol	Rating	Units
Continuous Forward Current	I_F	100	mA
Peak Forward Current	I_{FP}	1.0	A
Reverse Voltage	V_R	5	V
Operating Temperature	T_{opr}	-40 ~ +85	°C
Storage Temperature	T_{stg}	-40 ~ +85	°C
Soldering Temperature	T_{sol}	260	°C
Power Dissipation at(or below) 25°C Free Air Temperature	P_d	150	mW

Notes: *1: I_{FP} Conditions--Pulse Width $\leq 100 \mu s$ and Duty $\leq 1\%$.

*2:Soldering time ≤ 5 seconds.

Electro-Optical Characteristics (Ta=25°C)

Parameter	Symbol	Condition	Min.	Typ.	Max.	Units
Radiant Intensity	Ee	I _F =20mA	7.8	15	--	mW/sr
		I _F =100mA Pulse Width ≤ 100 μs ,Duty ≤ 1%	--	80	--	
		I _F =1A Pulse Width ≤ 100 μs ,Duty ≤ 1%.	--	800	--	
Peak Wavelength	λ p	I _F =20mA	--	850	--	nm
Spectral Bandwidth	Δ λ	I _F =20mA	--	45	--	nm
Forward Voltage	V _F	I _F =20mA		1.45	1.65	V
		I _F =100mA Pulse Width ≤ 100 μs ,Duty ≤ 1%	--	1.80	2.40	
		I _F =1A Pulse Width ≤ 100 μs ,Duty ≤ 1%.	--	4.10	5.25	
Reverse Current	I _R	V _R =5V	--	--	10	μ A
View Angle	2 θ 1/2	I _F =20mA	--	30	--	deg

Rank

 Condition: I_F=20mA

Unit: mW/sr

Bin number	M	N	P	Q	R
Min	7.8	11.0	15.0	21.0	30.0
Max	12.5	17.6	24.0	34.0	48.0

Typical Electro-Optical Characteristics Curves

Fig.1 Forward Current vs. Ambient Temperature

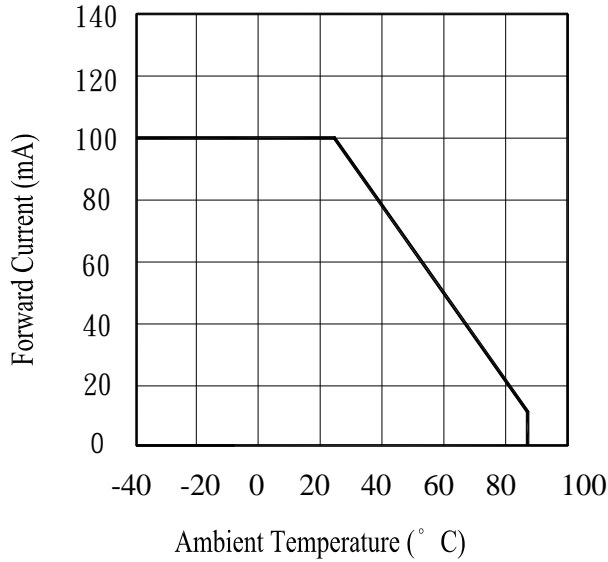

Fig.2 Spectral Distribution

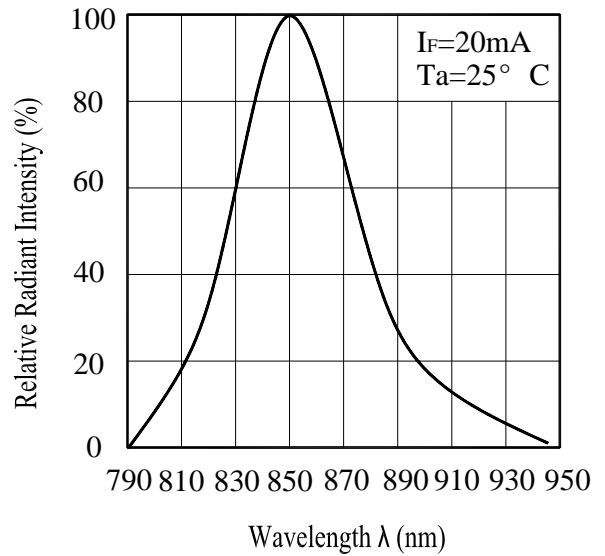

Fig.3 Peak Emission Wavelength vs. Ambient Temperature

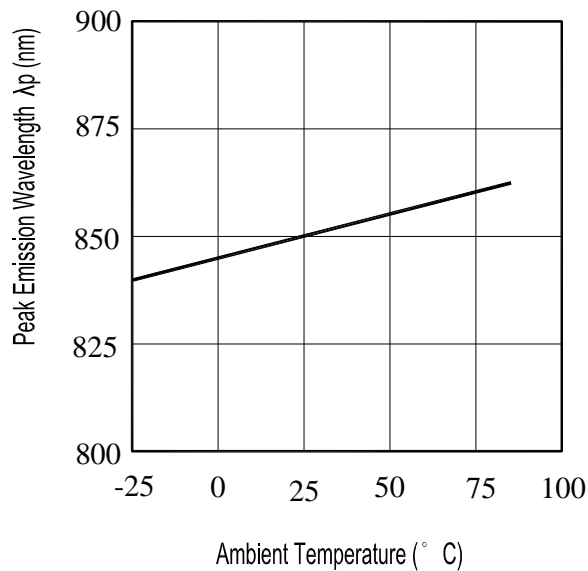
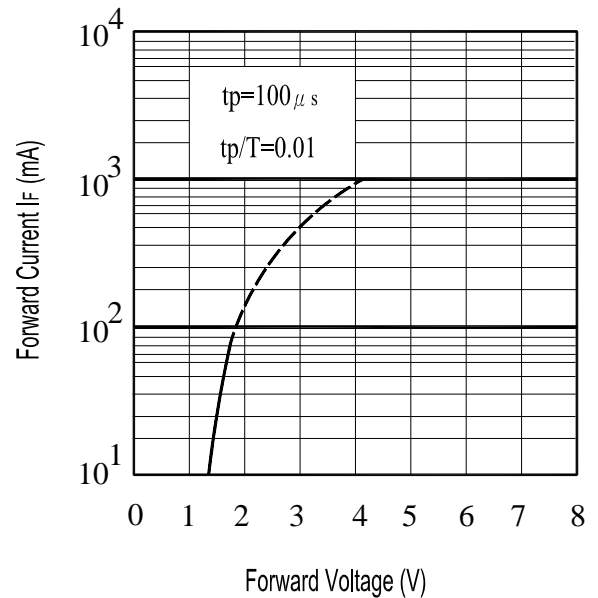

Fig.4 Forward Current vs. Forward Voltage



Typical Electro-Optical Characteristics Curves

Fig.5 Relative Intensity vs. Forward Current

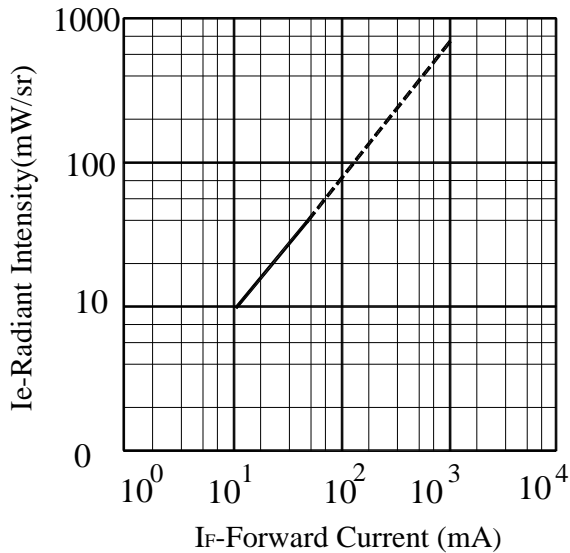

Fig.6 Relative Radiant Intensity vs. Angular Displacement

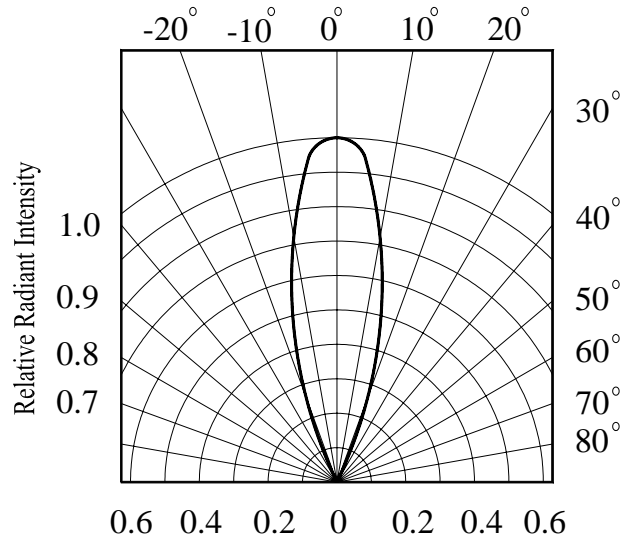

Fig.7 Relative Intensity vs. Ambient Temperature(°C)

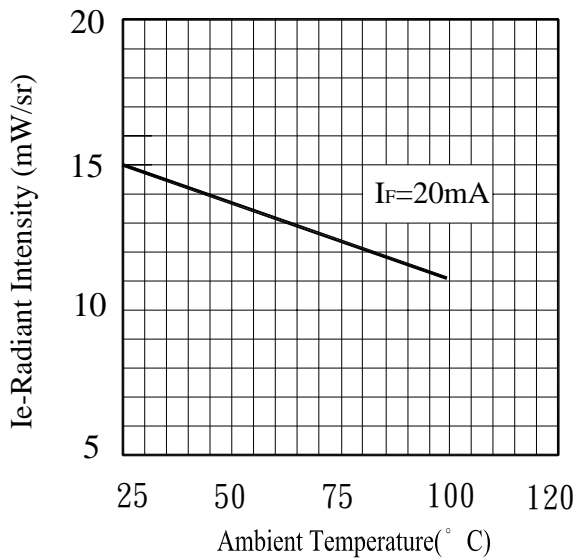
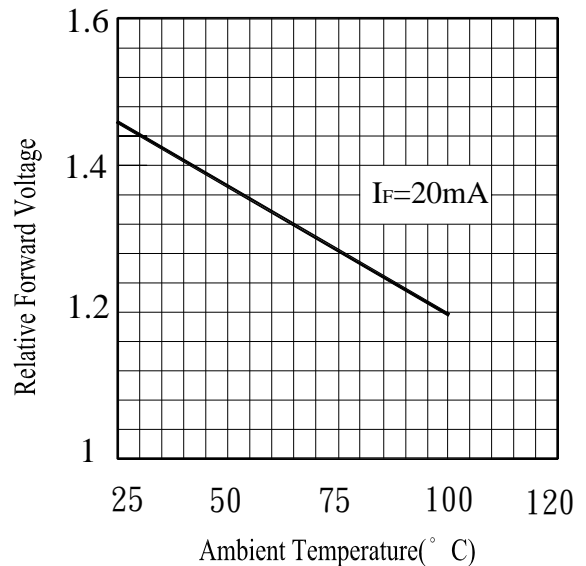

Fig.8 Forward Voltage vs. Ambient Temperature(°C)



Packing Quantity Specification

- 1.500PCS/1Bag , 5Bags/1Box
- 2.10Boxes/1Carton

Label Form Specification

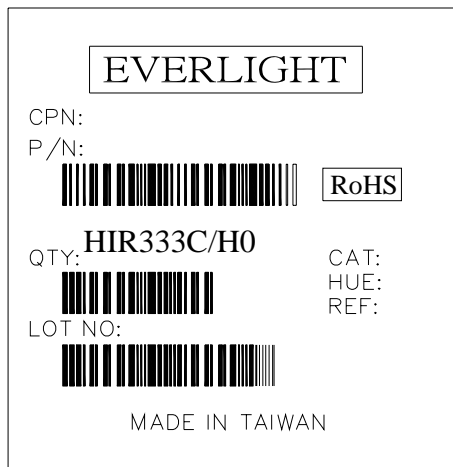

- CPN: Customer's Production Number
- P/N : Production Number
- QTY: Packing Quantity
- CAT: Ranks
- HUE: Peak Wavelength
- REF: Reference
- LOT No: Lot Number
- MADE IN TAIWAN: Production Place

Notes

1. Above specification may be changed without notice. EVERLIGHT will reserve authority on material change for above specification.
2. When using this product, please observe the absolute maximum ratings and the instructions for using outlined in these specification sheets. EVERLIGHT assumes no responsibility for any damage resulting from use of the product which does not comply with the absolute maximum ratings and the instructions included in these specification sheets.
3. These specification sheets include materials protected under copyright of EVERLIGHT corporation. Please don't reproduce or cause anyone to reproduce them without EVERLIGHT's consent.

EVERLIGHT ELECTRONICS CO., LTD.
Office: No 25, Lane 76, Sec 3, Chung Yang Rd,
Tucheng, Taipei 236, Taiwan, R.O.C

Tel: 886-2-2267-2000, 2267-9936
Fax: 886-2267-6244, 2267-6189, 2267-6306
<http://www.everlight.com>