

BRIGHT LED ELECTRONICS CORP.

LED DISPLAY SPECIFICATION

●COMMODITY : 2.30"(56.90mm) SINGLE DIGIT LED DISPLAY

PAGE: 2

●DEVICE NUMBER : BS-AD44RD

VERSION : 1.0

●ELECTRICAL AND OPTICAL CHARACTERISTICS (Ta=25°C)

Chip		Absolute Maximum Rating				Electro-optical Data (At 10mA)			Surface Color	Segment Color
Emitted Color	Peak Wave Length λ_p (nm)	$\Delta \lambda$ (nm)	Pd (mW)	If (mA)	Peak If(mA)	Vf(V)		Iv Typ. (mcd)		
						Typ.	Max.			
Hi-Eff Red	635	45	310	30	150	7.6	10.0	12	Black	White

●ABSOLUTE MAXIMUM RATINGS (Ta=25°C)

Reverse Voltage 5V
 Reverse Current ($V_R=5V$) 100 μ A
 Operating Temperature Range -40°C ~ 80°C
 Storage Temperature Range -40°C ~ 85°C
 Lead Soldering Temperature (1/16" From Body).....260°C For 5 Seconds

PACKAGE DIMENSIONS:

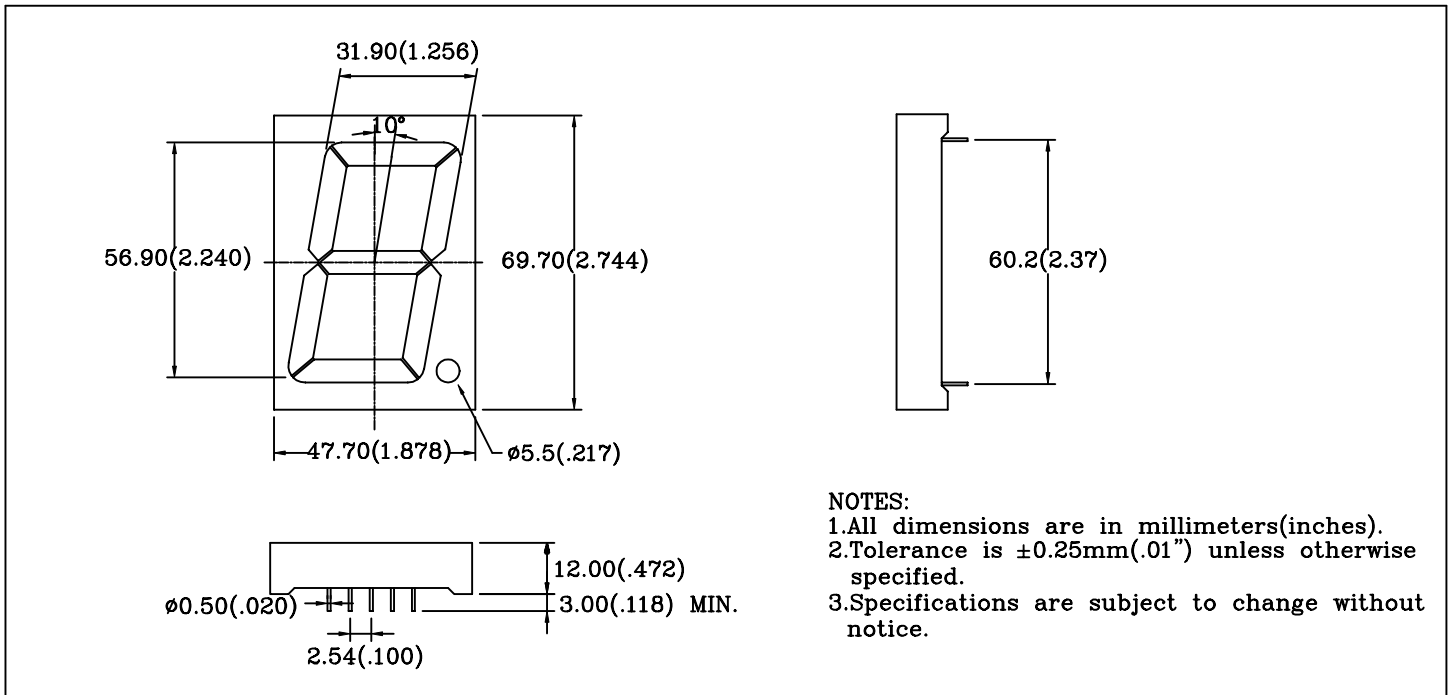

PIN FUNCTIONS:

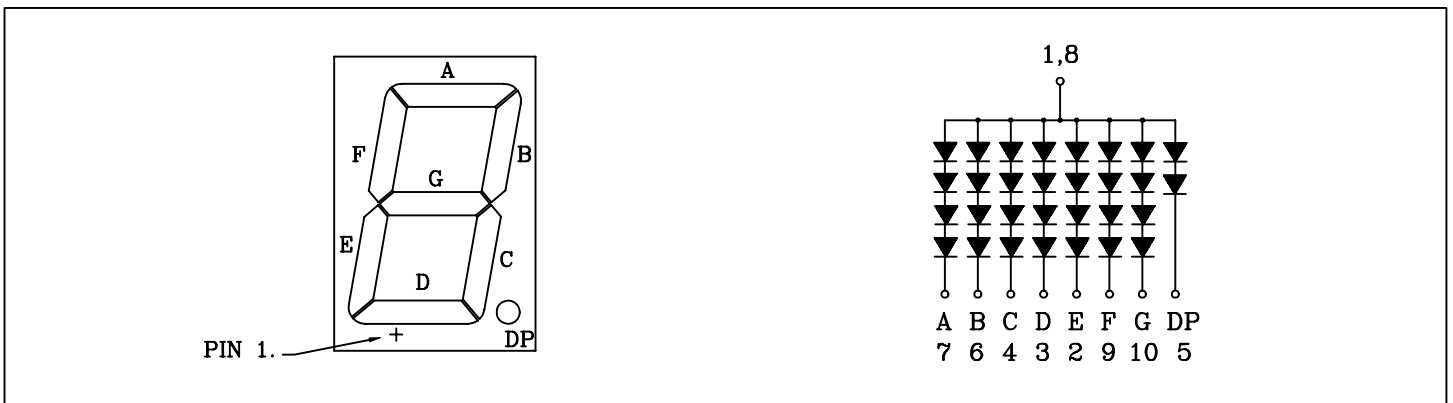

BRIGHT LED ELECTRONICS CORP.

TYPICAL CHARACTERISTICS

PAGE: 3

DEVICE NUMBER:BS-AD44RD

VERSION:1.0

SPECTRAL DISTRIBUTION

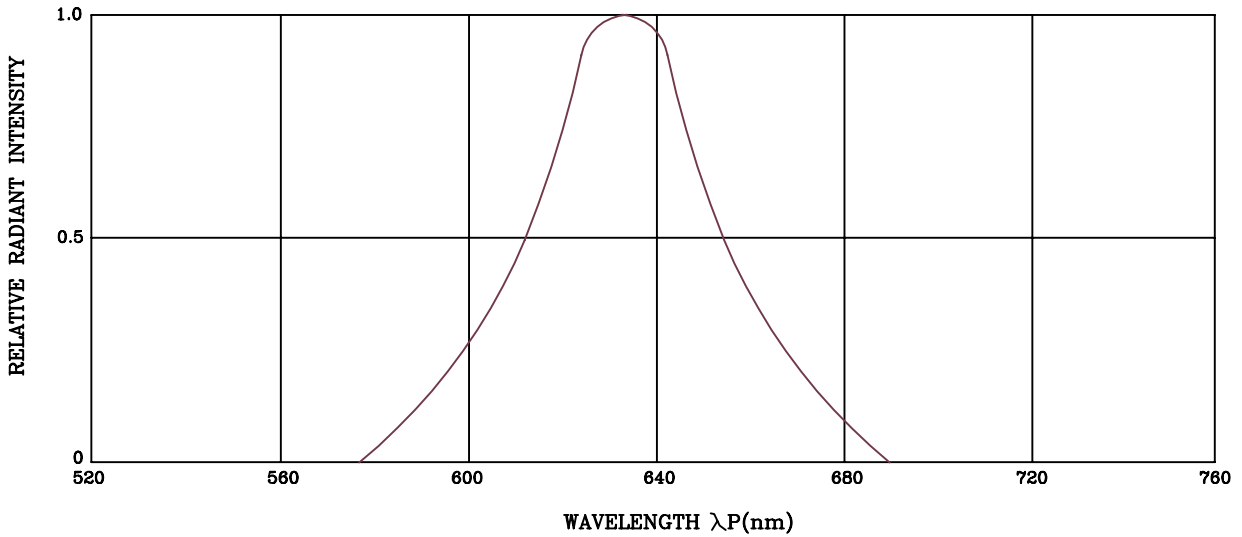

FORWARD CURRENT VS. FORWARD VOLTAGE

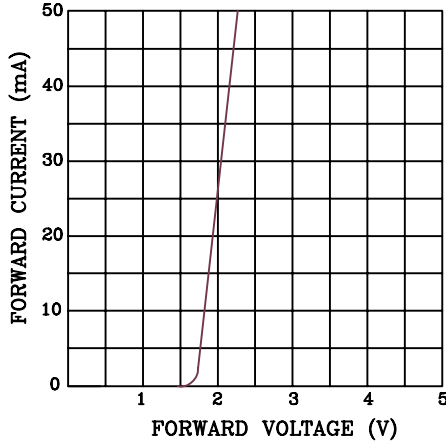

RELATIVE LUMINOUS INTENSITY VS. AMBIENT TEMPERATURE

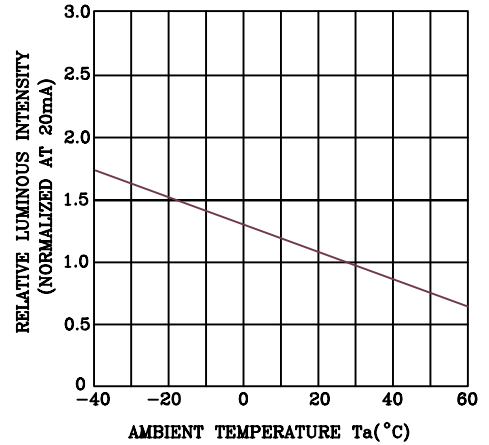

RELATIVE LUMINOUS INTENSITY VS. FORWARD CURRENT

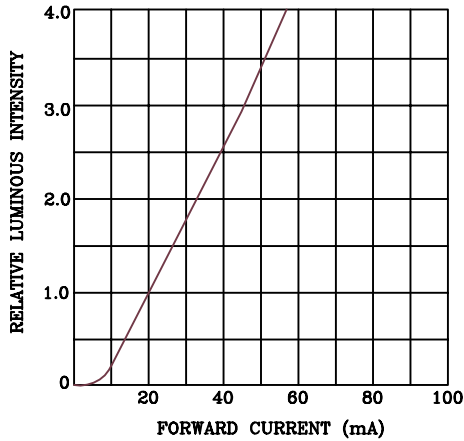

FORWARD CURRENT DERATING CURVE

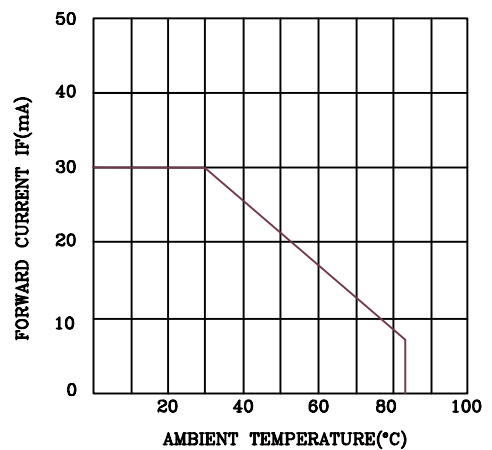

RELIABILITY TEST

PAGE: 4

DEVICE NO.: BS-AD44RD

VERSION:1.0

Classification	Test Item	Reference Standard	Test Conditions	Result
Endurance Test	Operation Life	MIL-STD-750:1026 MIL-STD-883:1005 JIS C 7021 :B-1	Connect with a power If=30mA Ta=Under room temperature Test time=1,000hrs(-24hrs,+72hrs)	0/10
	High Temperature High Humidity Storage	MIL-STD-202:103B JIS C 7021 :B-11	Ta=65°C ± 5°C RH=90%-95% Test time=240hrs±2hrs	0/10
	High Temperature Storage	MIL-STD-883:1008 JIS C 7021 :B-10	High Ta=85°C ± 5°C Test time=1,000hrs(-24hrs,+72hrs)	0/10
	Low Temperature Storage	JIS-C-7021 :B-12	Low Ta= -35°C ± 5°C Test time=1,000hrs(-24hrs,+72hrs)	0/10
Environmental Test	Temperature Cycling	MIL-STD-202:107D MIL-STD-750:1051 MIL-STD-883:1010 JIS C 7021 :A-4	-35°C ~ 25°C ~ 85°C ~ 25°C 30min 5min 30min 5min Test Time=10cycle	0/10
	Thermal Shock	MIL-STD-202:107D MIL-STD-750:1051 MIL-STD-883:1011	85°C ± 5°C ~ -35°C ± 5°C 10min 10min Test Time=10cycle	0/10
	Solder Resistance	MIL-STD-202:201A MIL-STD-750:2031 JIS C 7021 :A-1	T.sol=260 ± 5°C Dwell Time=10 ± 1 sec.	0/10
	Solderability	MIL-STD-202:208D MIL-STD-750:2026 MIL-STD-883:2003 JIS C 7021 :A-2	T.sol=230 ± 5°C Dwell Time=5 ± 1 sec.	0/10

JUDGMENT CRITERIA OF FAILURE FOR THE RELIABILITY

Measuring items	Symbol	Measuring conditions	Judgement criteria for failure
Forward voltage	VF	IF=10mA	Over Ux1.2
Reverse current	IR	VR=5V	Over Ux2
Luminous intensity	IV	IF=10mA	Below Sx0.5

Note: 1.U means the upper limit of specified characteristics. S means initial value.

2.Measurment shall be taken between 2 hours and after the test pieces have been returned to normal ambient conditions after completion of each test.