

# BRIGHT LED ELECTRONICS CORP.

## LED LAMPS SPECIFICATION

PAGE: 2

VERSION : 1.0

●COMMODITY : T-1x3/4 1.0"Lead, Narrow Viewing Angle 5 φ

●DEVICE NUMBER : BL-BG33J7M

●ELECTRICAL AND OPTICAL CHARACTERISTICS (Ta=25°C)

Chip		Lens Appearance	Absolute Maximum Rating				Electro-optical Data (At 20mA)			Viewing Angle 2 θ 1/2 (deg)
Emitted Color	Peak Wave Length λ P(nm)		Δ λ (nm)	Pd (mW)	If (mA)	Peak If(mA)	Vf(V)		Iv Typ. (mcd)	
							Typ.	Max.		
Super Green	574	Water Clear	30	75	30	150	2.4	2.8	2000	8

Remark : Viewing angle is the Off-axis angle at which the luminous intensity is half the axial luminous intensity.

●ABSOLUTE MAXIMUN RATINGS (Ta=25°C)

Reverse Voltage .....	5V
Reverse Current (Vr=5V) .....	100μA
Operating Temperature Range .....	-40°C ~ 80°C
Storage Temperature Range .....	-40°C ~ 85°C
Lead Soldering Temperature .....	260°C For 5 Seconds

●PACKAGE DIMENSIONS

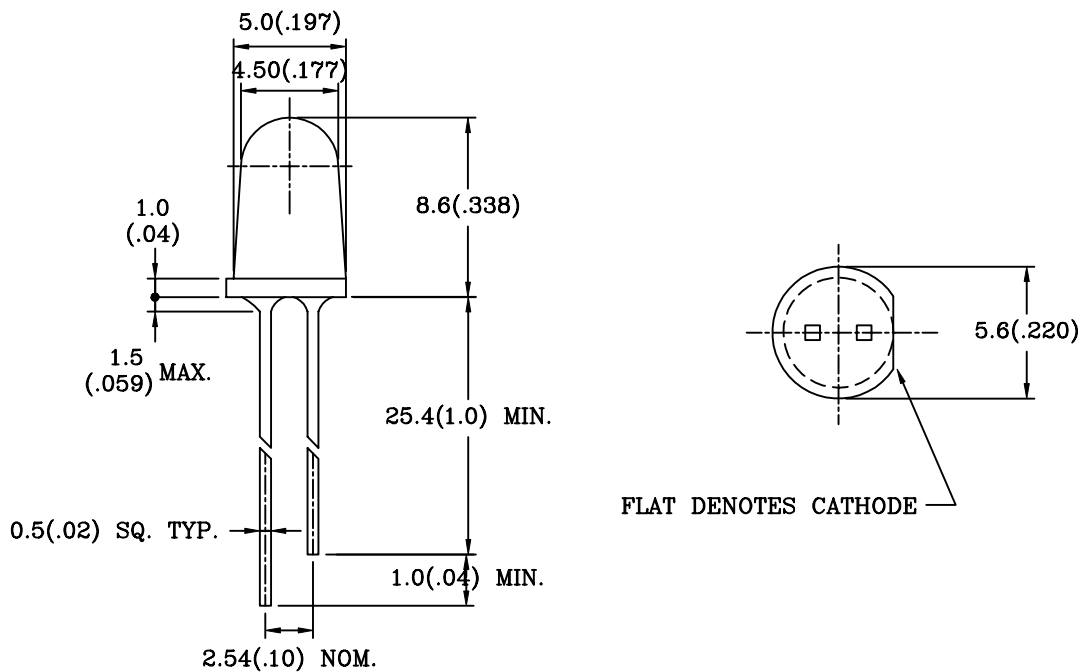

NOTES: 1.All dimensions are in millimeters (inches).

2.Tolerance is ± 0.25mm (0.01") unless otherwise specified.

3.Lead spacing is measured where the leads emerge from the package.

4.Specifications are subject to change without notice.

# BRIGHT LED ELECTRONICS CORP.

## LED LAMPS SPECIFICATION

● COMMODITY: T-13/4 1.0" Lead, Narrow Viewing Angle 5°

● DEVICE NUMBER: BL-BG33J7M

PAGE: 3

● ELECTRICAL AND OPTICAL CHARACTERISTICS (Ta=25°C)

REVISION: 1.0

SPECTRAL DISTRIBUTION

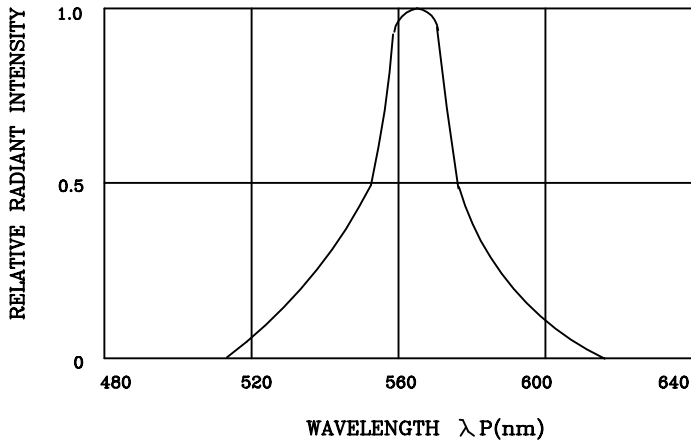

FORWARD CURRENT DERATING CURVE

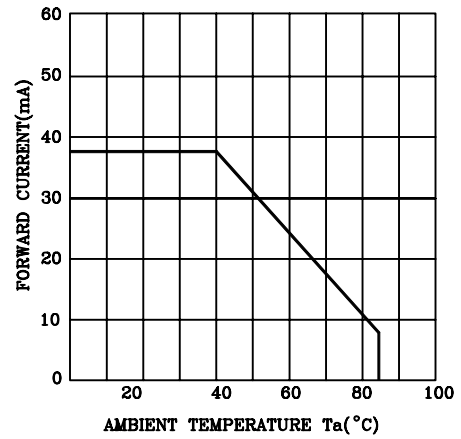

FORWARD CURRENT VS. FORWARD VOLTAGE

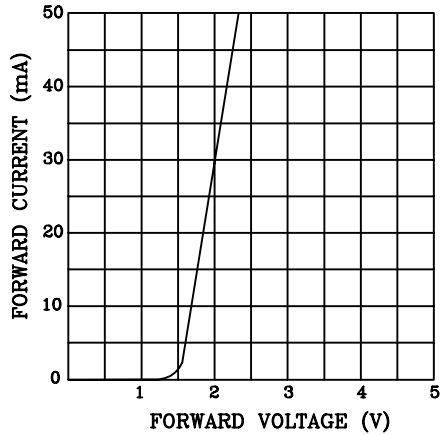

RELATIVE LUMINOUS INTENSITY VS. AMBIENT TEMPERATURE

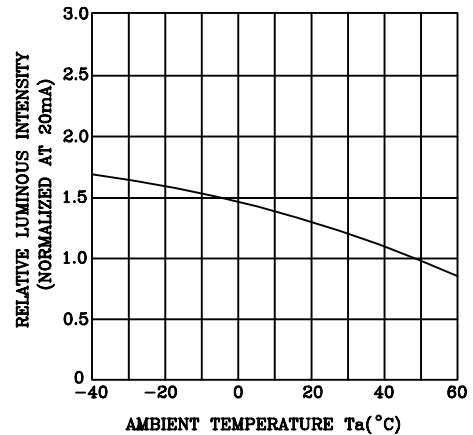

RELATIVE LUMINOUS INTENSITY VS. FORWARD CURRENT

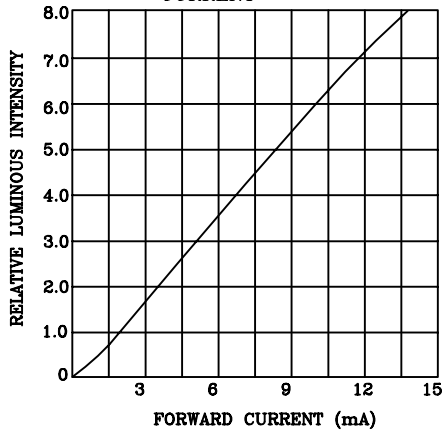

RADIANT DIAGRAM

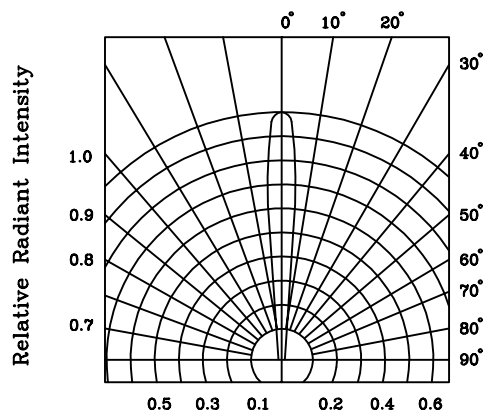

# BRIGHT LED ELECTRONICS CORP.

## LED LAMP SPECIFICATION

### RELIABILITY TEST

PAGE: 4

REVISION: 1.0

Classification	Test Item	Reference Standard	Test Conditions	Result
Endurance Test	Operation Life	MIL-STD-750:1026 MIL-STD-883:1005 JIS C 7021 :B-1	Connect with a power If=30mA Ta=Under room temperature Test time=1,000hrs	0/100
	High Temperature High Humidity Storage	MIL-STD-202:103B JIS C 7021 :B-11	Ta=85°C±5°C RH=90%-95% Test time=1,000hrs	0/100
	High Temperature Storage	MIL-STD-883:1008 JIS C 7021 :B-10	High Ta=85°C±5°C Test time=1,000hrs	0/100
	Low Temperature Storage	JIS-C-7021 :B-12	Low Ta=-35°C±5°C Test time=1,000hrs	0/100
Environmental Test	Temperature Cycling	MIL-STD-202:107D MIL-STD-750:1051 MIL-STD-883:1010 JIS C 7021 :A-4	-35°C ~ 25°C ~ 85°C ~ 25°C 30min 5min 30min 5min Test Time=10cycle	0/100
	Thermal Shock	MIL-STD-202:107D MIL-STD-750:1051 MIL-STD-883:1011	85°C±5°C ~ -35°C±5°C 10min 10min Test Time=10cycle	0/100
	Solder Resistance	MIL-STD-202:201A MIL-STD-750:2031 JIS C 7021 :A-1	T.sol=260±5°C Dwell Time=10±1sec.	0/50
	Solderability	MIL-STD-202:208D MIL-STD-750:2026 MIL-STD-883:2003 JIS C 7021 :A-2	T.sol=230±5°C Dwell Time=5±1sec.	0/50
	Lead Bending Stress	MIL-STD-750:2036 JIS C 7021 :A-11	0°~90°~0°bend , 3 cycles Weight 250g	0/50

### JUDGMENT CRITERIA OF FAILURE FOR THE RELIABILITY

Measuring items	Symbol	Measuring conditions	Judgement criteria for failure
Forward voltage	VF	IF=20mA	Over Ux1.2
Reverse current	IR	VR=5V	Over Ux2
Luminous intensity	IV	IF=20mA	Below Sx0.5

Note: 1.U means the upper limit of specified characteristics. S means initial value.

2.Measurment shall be taken between 2 hours and after the test pieces have been returned to normal ambient conditions after completion of each test.