

## ■ General Description

The AME8807 family of positive, linear regulators feature low ground current (30 $\mu$ A Typ.) with low dropout voltage, making them ideal for battery applications. The space-saving SOP-8 & DFN-8 (3mmx3mmx0.6mm) packages are attractive for "Pocket" and "Hand Held" applications.

These rugged devices have both Thermal Shutdown, and Current Fold-back to prevent device failure under the "Worst" of operating conditions.

The AME8807 is stable with an output capacitance of 2.2 $\mu$ F or greater.

## ■ Features

- Very Low Dropout Voltage
- Guaranteed 600mA Output
- Typical 30 $\mu$ A Quiescent Current
- Accurate to within 1.5%
- Over-Temperature Shutdown
- Current Limiting
- Short Circuit Current Fold-back
- Power-Saving Shutdown Mode
- Space-Saving SOP-8 & DFN-8 (3mmx3mmx0.6mm) Packages
- User Adjustable Output Voltages
- Low Temperature Coefficient
- All AME's Lead Free Products Meet RoHS Standards

## ■ Applications

- Instrumentation
- Portable Electronics
- Wireless Devices
- Cordless Phones
- PC Peripherals
- Battery Powered Widgets

## ■ Functional Block Diagram

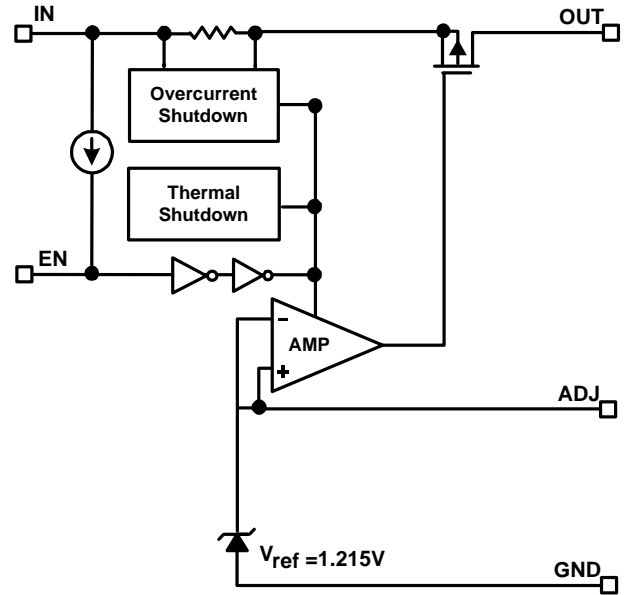

## ■ Typical Application

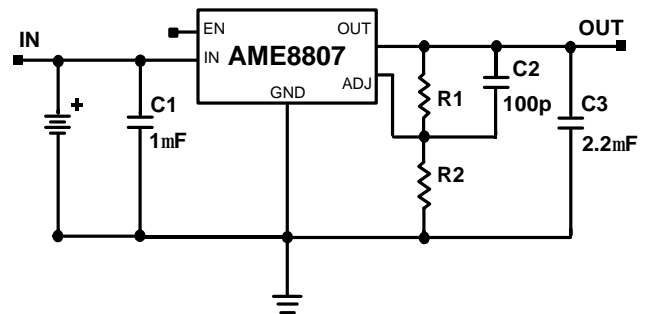

$$V_{OUT} = 1.215 ( R1/R2 + 1 )$$

C2 is unnecessary if R1 or R2 < 20 K Ohms

R<sub>1</sub> and R<sub>2</sub> use resistance value within 1% accuracy for correct V<sub>OUT</sub>

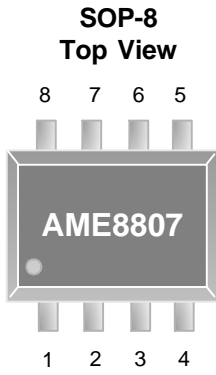
**■ Pin Configuration**

**AME8807AEHA**

1. IN
2. GND
3. GND
4. EN
5. ADJ
6. GND
7. GND
8. OUT

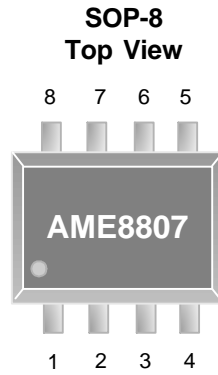
**\* Die Attach:  
Conductive Epoxy**

**AME8807BEHA**

1. OUT
2. ADJ
3. GND
4. NC
5. EN
6. NC
7. NC
8. IN

**\* Die Attach:  
Conductive Epoxy**

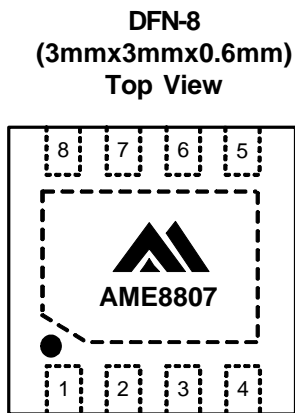
**AME8807AEVA**

1. EN
2. GND
3. GND
4. IN
5. OUT
6. GND
7. GND
8. ADJ

**\* Die Attach:  
Conductive Epoxy**

**Note:**

The area enclosed by dashed line represents Exposed Pad and connect to GND.



■ Ordering Information

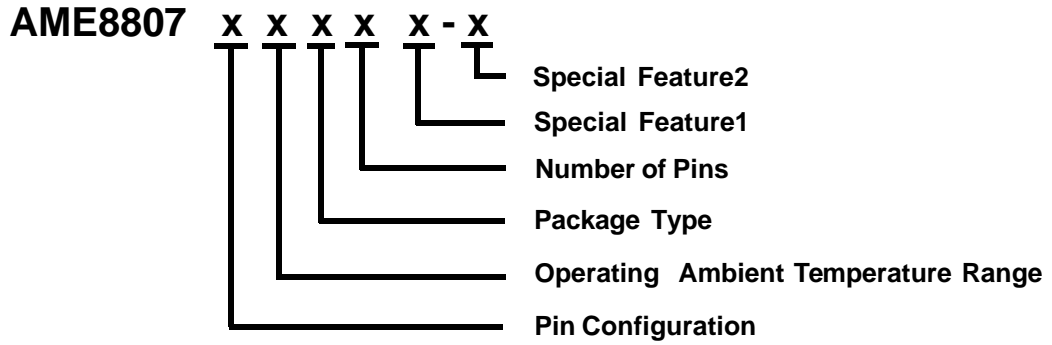

Pin Configuration	Operating Ambient Temperature Range	Package Type	Number of Pins	Special Feature 1	Special Feature 2 (For DFN package only)
A: 1. IN (SOP-8) 2. GND 3. GND 4. EN 5. ADJ 6. GND 7. GND 8. OUT  B: 1. OUT (SOP-8) 2. ADJ 3. GND 4. NC 5. EN 6. NC 7. NC 8. IN  A: 1. EN (DFN-8) 2. GND 3. GND 4. IN 5. OUT 6. GND 7. GND 8. ADJ	E: -40°C to 85°C	H: SOP-8 V: DFN	A: 8	Z: Lead Free Y: Lead Free & Low Profile	3: 3x3x0.6(mm) (LxWxH)



■ Ordering Information

Part Number	Marking*	Output Voltage	Package	Operating Ambient Temperature Range
AME8807AEHA	8807 AEHA yyww	Adjustable	SOP-8	- 40°C to 85°C
AME8807AEHAZ	8807 AEHA yyww	Adjustable	SOP-8	- 40°C to 85°C
AME8807BEHA	8807 BEHA yyww	Adjustable	SOP-8	- 40°C to 85°C
AME8807BEHAZ	8807 BEHA yyww	Adjustable	SOP-8	- 40°C to 85°C
AME8807AEVAY-3	BEX yyww	Adjustable	DFN-8 (3mmx3mmx0.6mm)	- 40°C to 85°C

Note: yyww represents the date code

\* A line on top of the first letter represents lead free plating such as  $\bar{8}$ 807

Please consult AME sales office or authorized Rep./Distributor for package type availability.

**■ Absolute Maximum Ratings**

Parameter	Maximum	Unit
Input Voltage	-0.3 to 8	V
EN Voltage	-0.3 to 8	V
Output Voltage	-0.3 to $V_{IN} + 0.3$	V
Output Current	$P_D / (V_{IN} - V_{OUT})$	mA
ESD Classification	B*	

Caution: Stress above the listed absolute maximum rating may cause permanent damage to the device.

\*HBM B:2000V~3999V

**■ Recommended Operating Conditions**

Parameter	Symbol	Rating	Unit
Ambient Temperature Range	$T_A$	- 40 to 85	°C
Junction Temperature Range	$T_J$	- 40 to 125	°C
Storage Temperature Range	$T_{STG}$	- 65 to 150	°C

**■ Thermal Information**

Parameter	Package	Die Attach	Symbol	Maximum	Unit
Thermal Resistance* (Junction to Case)	SOP-8	Conductive Epoxy	$\theta_{JC}$	60	°C / W
	DFN-6 (3mmx3mmx0.6mm)			17	
Thermal Resistance (Junction to Ambient)	SOP-8		$\theta_{JA}$	150	mW
	DFN-6 (3mmx3mmx0.6mm)			125	
Internal Power Dissipation	SOP-8		$P_D$	810	mW
	DFN-6 (3mmx3mmx0.6mm)			800	
Maximum Junction Temperature				150	°C
Solder Iron (10 Sec)**				350	°C

\* Measure  $\theta_{JC}$  on center of molding compound if IC has no tab.

\*\* MIL-STD-202G 210F

**■ Electrical Specifications**

TA = 25°C unless otherwise noted

Parameter	Symbol	Test Condition	Min	Typ	Max	Units
Input Voltage	$V_{IN}$		Note 1		7	V
Output Voltage Accuracy	$V_O$	$I_O=1mA$	-1.5		1.5	%
Dropout Voltage	$V_{DROPOUT}$	$I_O=600mA$ $V_O=V_{O(NOM)}-2.0\%$	$1.5V < V_{O(NOM)} \leq 2.0V$	See chart	1400	mV
			$2.0V < V_{O(NOM)} \leq 2.8V$		800	
			$2.8V < V_{O(NOM)}$		600	
Output Current	$I_O$	$V_O > 1.2V$	600			mA
Current Limit	$I_{LIM}$	$V_O > 1.2V$	600	800		mA
Short Circuit Current	$I_{SC}$	$V_O < 0.8V$		300	600	mA
Quiescent Current (For Fixed Output Voltage Options)	$I_Q$	$I_O=0mA$		30	50	$\mu A$
Ground Pin Current	$I_{GND}$	$I_O=1mA$ to 600mA		30		$\mu A$
Line Regulation	$REG_{LINE}$	$I_O=1mA$ $V_{IN}=V_O+1$ to $V_O+2$	$V_O < 2.0V$		0.15	%
			$V_O \geq 2.0V$	0.02	0.1	%
Load Regulation	$REG_{LOAD}$	$I_O=1mA$ to 600mA		0.2	1	%
Over Temperature Shutdown	OTS			150		°C
Over Temperature Hysterisis	OTH			30		°C
$V_O$ Temperature Coefficient	TC			30		ppm/°C
Power Supply Rejection	PSRR	$I_O=100mA$ $C_O=2.2\mu F$	$f=1kHz$		50	dB
			$f=10kHz$		20	
			$f=100kHz$		15	
Output Voltage Noise	eN	$f=10Hz$ to 100kHz $I_O=10mA$	$C_O=2.2\mu F$		30	$\mu V_{rms}$
ADJ Reference Voltage	$V_{REF}$		1.203	1.215	1.227	V
EN Input Threshold	$V_{EH}$	$V_{IN}=2.7V$ to 7V	2.0		$V_{in}$	V
	$V_{EL}$	$V_{IN}=2.7V$ to 7V	0		0.4	V
EN Input Bias Current	$I_{EH}$	$V_{EN}=V_{IN}$ , $V_{IN}=2.7V$ to 7V			0.1	$\mu A$
	$I_{EL}$	$V_{EN}=0V$ , $V_{IN}=2.7V$ to 7V			0.5	$\mu A$
Shutdown Supply Current	$I_{SD}$	$V_{IN}=5V$ , $V_O=0V$ , $V_{EN} < V_{EL}$		0.5	1	$\mu A$

 Note1:  $V_{IN(min)} = V_{OUT} + V_{DROPOUT}$



## ■ Detailed Description

The AME8807 family of CMOS regulators contain a PMOS pass transistor, voltage reference, error amplifier, over-current protection, and thermal shutdown.

The P-channel pass transistor receives data from the error amplifier, over-current shutdown, and thermal protection circuits. During normal operation, the error amplifier compares the output voltage to a precision reference. Over-current and Thermal shutdown circuits become active when the junction temperature exceeds 150°C, or the current exceeds 600mA. During thermal shutdown, the output voltage remains low. Normal operation is restored when the junction temperature drops below 120°C.

The AME8807 switches from voltage mode to current mode when the load exceeds the rated output current. This prevents over-stress. The AME8807 also incorporates current fold-back to reduce power dissipation when the output is short circuited. This feature becomes active when the output drops below 0.8 volts, and reduces the current flow by 65%. Full current is restored when the voltage exceeds 0.8 volts.

## ■ External Capacitors

The AME8807 is stable with an output capacitor to ground of 2.2 $\mu$ F or greater. Ceramic capacitors have the lowest ESR, and will offer the best AC performance. Conversely, Aluminum Electrolytic capacitors exhibit the highest ESR, resulting in the poorest AC response. Unfortunately, large value ceramic capacitors are comparatively expensive. One option is to parallel a 0.1 $\mu$ F ceramic capacitor with a 10 $\mu$ F Aluminum Electrolytic. The benefit is low ESR, high capacitance, and low overall cost.

A second capacitor is recommended between the input and ground to stabilize  $V_{in}$ . The input capacitor should be at least 0.1 $\mu$ F to have a beneficial effect.

All capacitors should be placed in close proximity to the pins. A "Quiet" ground termination is desirable. This can be achieved with a "Star" connection.

## ■ Enable

The Enable pin normally floats high. When actively, pulled low, the PMOS pass transistor shuts off, and all internal circuits are powered down. In this state, the quiescent current is less than 1 $\mu$ A. This pin behaves much like an electronic switch.

## ■ ADJ

The ADJ pin is the positive input to the error amplifier which, due to the pmos pass element inversion, means it is actually the negative input of the LDO feedback loop. The feedback works to keep the voltage at the ADJ pin 1.215V with respect to ground. Since the internal circuitry at the ADJ pin is essentially an ESD protected CMOS gate the input current at the ADJ pin is virtually zero.



Ground Current vs. Input Voltage

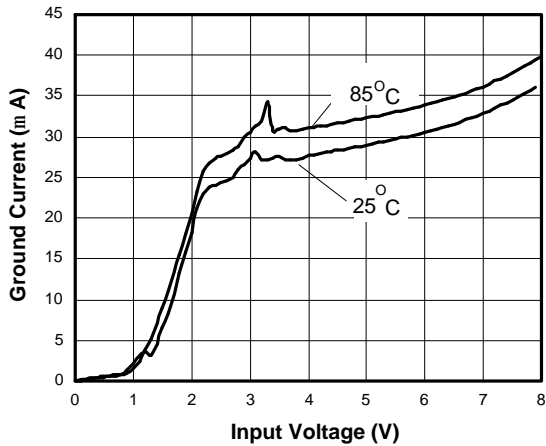

Load Step (1mA-600mA)

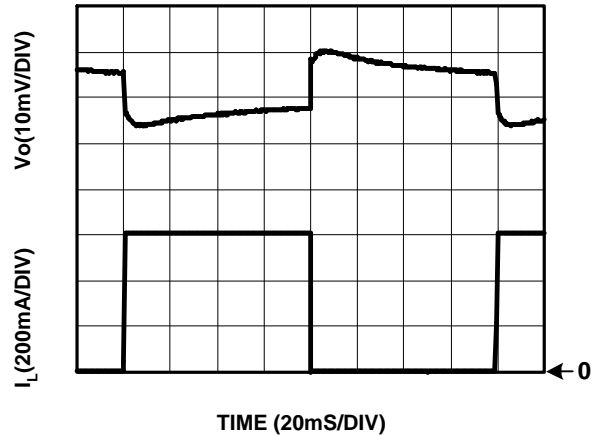

Drop Out Voltage vs. Output Voltage

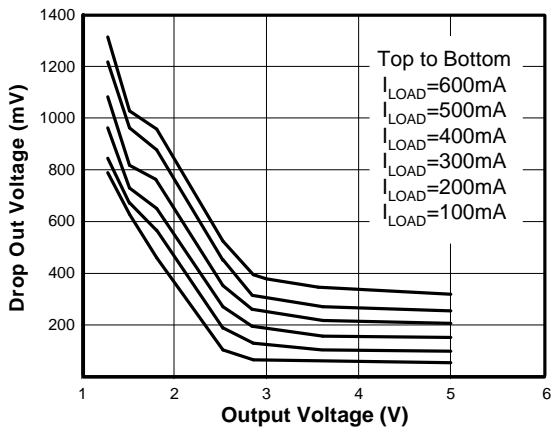

Power Supply Rejection Ratio

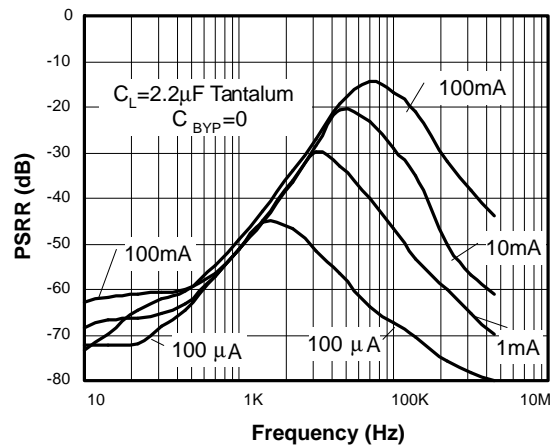

Safe Operating Area

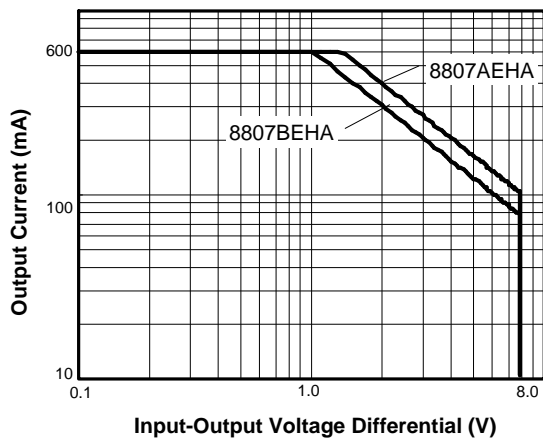

Noise Measurement

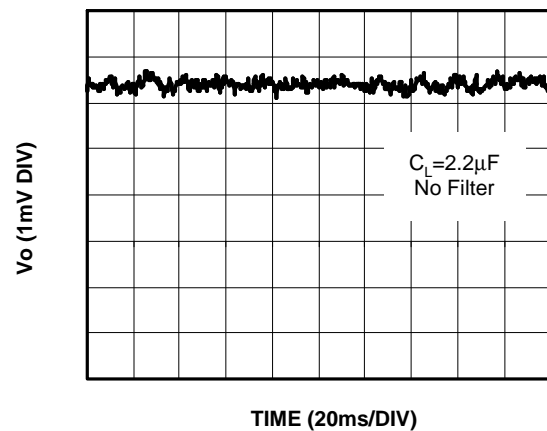





Overtemperature Shutdown

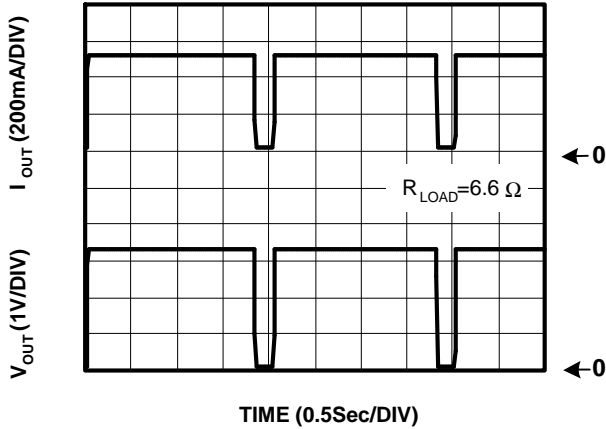

Current Limit Response

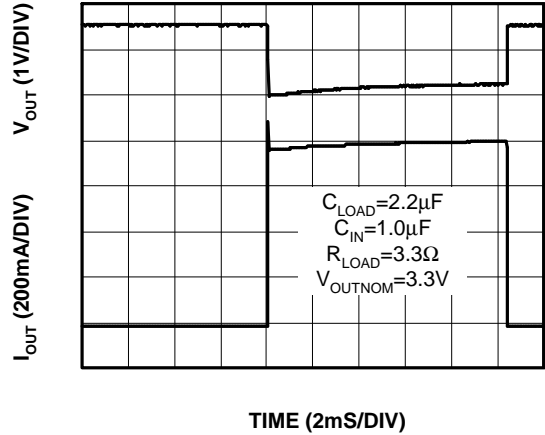

Short Circuit Response

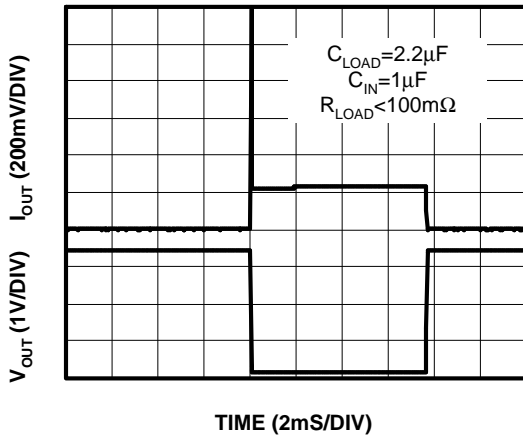

Chip Enable Transient Response

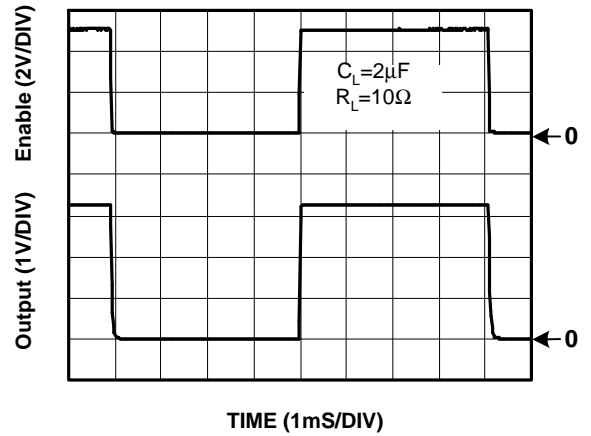

Line Transient Response

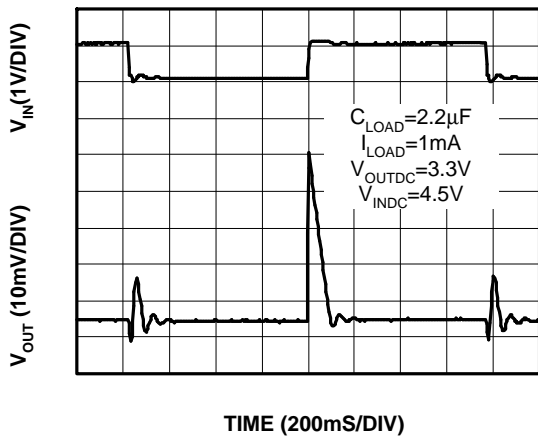



External Resistor Divider Table

R1 (K Ohm)	1	2	3	4	5	6	7	8	9	10
Vout	$R2(K\ Ohm)=(1.215 \cdot R1(K\ Ohm))/(Vout-1.215)$									
1.30	14.29	28.59	42.88	57.18	71.47	85.76	100.06	114.35	128.65	142.94
1.35	9.00	18.00	27.00	36.00	45.00	54.00	63.00	72.00	81.00	90.00
1.40	6.57	13.14	19.70	26.27	32.84	39.41	45.97	52.54	59.11	65.68
1.45	5.17	10.34	15.51	20.68	25.85	31.02	36.19	41.36	46.53	51.70
1.50	4.26	8.53	12.79	17.05	21.32	25.58	29.84	34.11	38.37	42.63
1.55	3.63	7.25	10.88	14.51	18.13	21.76	25.39	29.01	32.64	36.27
1.60	3.16	6.31	9.47	12.62	15.78	18.94	22.09	25.25	28.40	31.56
1.65	2.79	5.59	8.38	11.17	13.97	16.76	19.55	22.34	25.14	27.93
1.70	2.51	5.01	7.52	10.02	12.53	15.03	17.54	20.04	22.55	25.05
1.75	2.27	4.54	6.81	9.08	11.36	13.63	15.90	18.17	20.44	22.71
1.80	2.08	4.15	6.23	8.31	10.38	12.46	14.54	16.62	18.69	20.77
1.85	1.91	3.83	5.74	7.65	9.57	11.48	13.39	15.31	17.22	19.13
1.90	1.77	3.55	5.32	7.09	8.87	10.64	12.42	14.19	15.96	17.74
1.95	1.65	3.31	4.96	6.61	8.27	9.92	11.57	13.22	14.88	16.53
2.00	1.55	3.10	4.64	6.19	7.74	9.29	10.83	12.38	13.93	15.48
2.05	1.46	2.91	4.37	5.82	7.28	8.73	10.19	11.64	13.10	14.55
2.10	1.37	2.75	4.12	5.49	6.86	8.24	9.61	10.98	12.36	13.73
2.15	1.30	2.60	3.90	5.20	6.50	7.80	9.10	10.40	11.70	12.99
2.20	1.23	2.47	3.70	4.93	6.17	7.40	8.63	9.87	11.10	12.34
2.25	1.17	2.35	3.52	4.70	5.87	7.04	8.22	9.39	10.57	11.74
2.30	1.12	2.24	3.36	4.48	5.60	6.72	7.84	8.96	10.08	11.20
2.35	1.07	2.14	3.21	4.28	5.35	6.42	7.49	8.56	9.63	10.70
2.40	1.03	2.05	3.08	4.10	5.13	6.15	7.18	8.20	9.23	10.25
2.45	0.98	1.97	2.95	3.94	4.92	5.90	6.89	7.87	8.85	9.84
2.50	0.95	1.89	2.84	3.78	4.73	5.67	6.62	7.56	8.51	9.46
2.55	0.91	1.82	2.73	3.64	4.55	5.46	6.37	7.28	8.19	9.10
2.60	0.88	1.75	2.63	3.51	4.39	5.26	6.14	7.02	7.90	8.77
2.65	0.85	1.69	2.54	3.39	4.23	5.08	5.93	6.77	7.62	8.47
2.70	0.82	1.64	2.45	3.27	4.09	4.91	5.73	6.55	7.36	8.18
2.75	0.79	1.58	2.37	3.17	3.96	4.75	5.54	6.33	7.12	7.92
2.80	0.77	1.53	2.30	3.07	3.83	4.60	5.37	6.13	6.90	7.67
2.85	0.74	1.49	2.23	2.97	3.72	4.46	5.20	5.94	6.69	7.43
2.90	0.72	1.44	2.16	2.88	3.61	4.33	5.05	5.77	6.49	7.21
2.95	0.70	1.40	2.10	2.80	3.50	4.20	4.90	5.60	6.30	7.00
3.00	0.68	1.36	2.04	2.72	3.40	4.08	4.76	5.45	6.13	6.81
3.05	0.66	1.32	1.99	2.65	3.31	3.97	4.63	5.30	5.96	6.62
3.10	0.64	1.29	1.93	2.58	3.22	3.87	4.51	5.16	5.80	6.45



■ External Resistor Divider Table (contd.)

R1 (K Ohm)	1	2	3	4	5	6	7	8	9	10
Vout	$R2(K\ Ohm)=(1.215*R1(K\ Ohm))/(Vout-1.215)$									
3.15	0.63	1.26	1.88	2.51	3.14	3.77	4.40	5.02	5.65	6.28
3.20	0.61	1.22	1.84	2.45	3.06	3.67	4.28	4.90	5.51	6.12
3.25	0.60	1.19	1.79	2.39	2.99	3.58	4.18	4.78	5.37	5.97
3.30	0.58	1.17	1.75	2.33	2.91	3.50	4.08	4.66	5.24	5.83
3.35	0.57	1.14	1.71	2.28	2.85	3.41	3.98	4.55	5.12	5.69
3.40	0.56	1.11	1.67	2.22	2.78	3.34	3.89	4.45	5.00	5.56
3.45	0.54	1.09	1.63	2.17	2.72	3.26	3.81	4.35	4.89	5.44
3.50	0.53	1.06	1.60	2.13	2.66	3.19	3.72	4.25	4.79	5.32
3.55	0.52	1.04	1.56	2.08	2.60	3.12	3.64	4.16	4.68	5.20
3.60	0.51	1.02	1.53	2.04	2.55	3.06	3.57	4.08	4.58	5.09
3.65	0.50	1.00	1.50	2.00	2.49	2.99	3.49	3.99	4.49	4.99
3.70	0.49	0.98	1.47	1.96	2.44	2.93	3.42	3.91	4.40	4.89
3.75	0.48	0.96	1.44	1.92	2.40	2.88	3.36	3.83	4.31	4.79
3.80	0.47	0.94	1.41	1.88	2.35	2.82	3.29	3.76	4.23	4.70
3.85	0.46	0.92	1.38	1.84	2.31	2.77	3.23	3.69	4.15	4.61
3.90	0.45	0.91	1.36	1.81	2.26	2.72	3.17	3.62	4.07	4.53
3.95	0.44	0.89	1.33	1.78	2.22	2.67	3.11	3.55	4.00	4.44
4.00	0.44	0.87	1.31	1.75	2.18	2.62	3.05	3.49	3.93	4.36
4.05	0.43	0.86	1.29	1.71	2.14	2.57	3.00	3.43	3.86	4.29
4.10	0.42	0.84	1.26	1.68	2.11	2.53	2.95	3.37	3.79	4.21
4.15	0.41	0.83	1.24	1.66	2.07	2.48	2.90	3.31	3.73	4.14
4.20	0.41	0.81	1.22	1.63	2.04	2.44	2.85	3.26	3.66	4.07
4.25	0.40	0.80	1.20	1.60	2.00	2.40	2.80	3.20	3.60	4.00
4.30	0.39	0.79	1.18	1.58	1.97	2.36	2.76	3.15	3.54	3.94
4.35	0.39	0.78	1.16	1.55	1.94	2.33	2.71	3.10	3.49	3.88
4.40	0.38	0.76	1.14	1.53	1.91	2.29	2.67	3.05	3.43	3.81
4.45	0.38	0.75	1.13	1.50	1.88	2.25	2.63	3.00	3.38	3.76
4.50	0.37	0.74	1.11	1.48	1.85	2.22	2.59	2.96	3.33	3.70
4.55	0.36	0.73	1.09	1.46	1.82	2.19	2.55	2.91	3.28	3.64
4.60	0.36	0.72	1.08	1.44	1.79	2.15	2.51	2.87	3.23	3.59
4.65	0.35	0.71	1.06	1.41	1.77	2.12	2.48	2.83	3.18	3.54
4.70	0.35	0.70	1.05	1.39	1.74	2.09	2.44	2.79	3.14	3.49
4.75	0.34	0.69	1.03	1.37	1.72	2.06	2.41	2.75	3.09	3.44
4.80	0.34	0.68	1.02	1.36	1.69	2.03	2.37	2.71	3.05	3.39
4.85	0.33	0.67	1.00	1.34	1.67	2.01	2.34	2.67	3.01	3.34
4.90	0.33	0.66	0.99	1.32	1.65	1.98	2.31	2.64	2.97	3.30
4.95	0.33	0.65	0.98	1.30	1.63	1.95	2.28	2.60	2.93	3.25
5.00	0.32	0.64	0.96	1.28	1.61	1.93	2.25	2.57	2.89	3.21

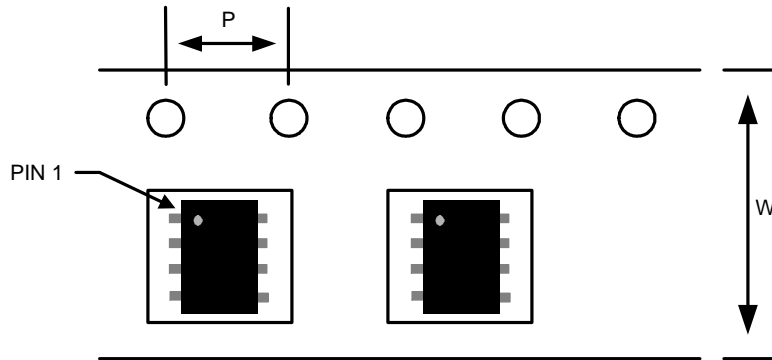
**■ Tape and Reel Dimension**
**SOP-8**

**Carrier Tape, Number of Components Per Reel and Reel Size**

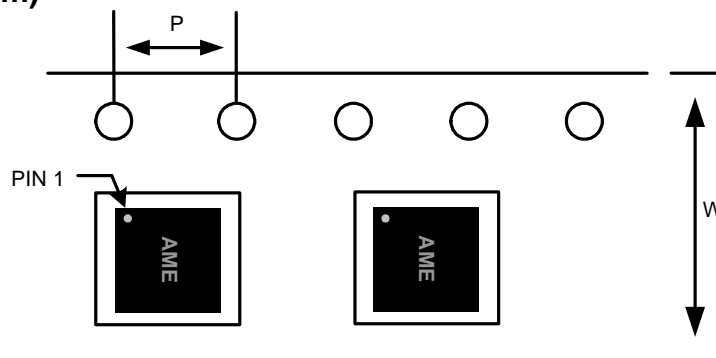
Package	Carrier Width (W)	Pitch (P)	Part Per Full Reel	Reel Size
SOP-8	12.0±0.1 mm	4.0±0.1 mm	2500pcs	330±1 mm

**DFN-8  
(3mmx3mmx0.6mm)**

**Carrier Tape, Number of Components Per Reel and Reel Size**

Package	Carrier Width (W)	Pitch (P)	Part Per Full Reel	Reel Size
DFN-8 (3x3x0.6mm)	8.0±0.1 mm	4.0±0.1 mm	3000pcs	330±1 mm

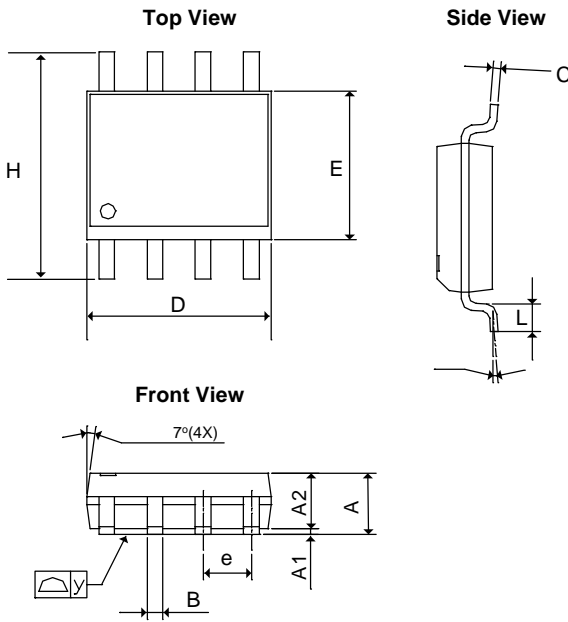

■ Package Dimension

SOP-8

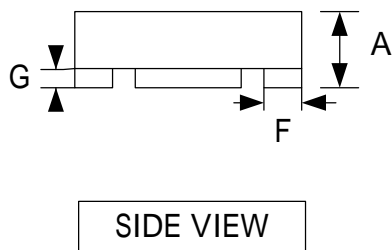
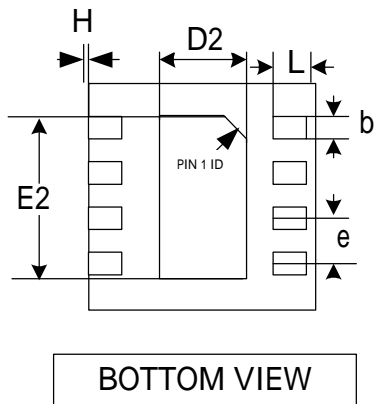
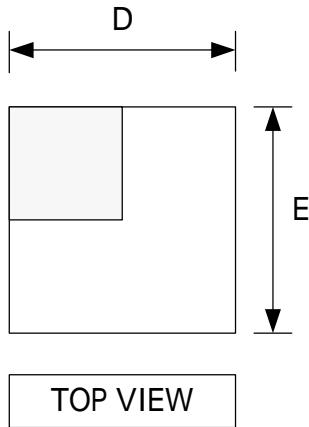

SYMBOLS	MILLIMETERS		INCHES	
	MIN	MAX	MIN	MAX
A	1.35	1.75	0.05315	0.0689
A <sub>1</sub>	0.10	0.30	0.00394	0.01181
A <sub>2</sub>	1.473 REF		0.05799 REF	
B	0.33	0.51	0.01299	0.02008
C	0.19	0.25	0.00748	0.00984
D	4.80	5.33	0.18898	0.20984
E	3.80	4.00	0.14961	0.15748
e	1.27 BSC		0.05000 BSC	
L	0.40	1.27	0.01575	0.05000
H	5.80	6.30	0.22835	0.24803
y	-	0.10	-	0.00394
q	0°	8°	0°	8°

**■ Package Dimension**
**DFN-8 (3mmx3mmx0.6mm)**

SYMBOLS	MILLIMETERS		INCHES	
	MIN	MAX	MIN	MAX
<b>A</b>	0.550	0.650	0.022	0.026
<b>D</b>	2.900	3.100	0.114	0.122
<b>E</b>	2.900	3.100	0.114	0.122
<b>F</b>	0.550 TYP.		0.220 TYP.	
<b>e</b>	0.650 TYP.		0.026 TYP.	
<b>D2</b>	1.500 TYP.		0.059 TYP.	
<b>E2</b>	2.400 TYP.		0.094 TYP.	
<b>b</b>	0.200	0.300	0.0079	0.012
<b>L</b>	0.450	0.550	0.018	0.022
<b>G</b>	0.010	0.090	0.0004	0.004
<b>H</b>	0.000	0.050	0.000	0.002



**www.ame.com.tw**  
**E-Mail: sales@ame.com.tw**

Life Support Policy:

These products of AME, Inc. are not authorized for use as critical components in life-support devices or systems, without the express written approval of the president of AME, Inc.

AME, Inc. reserves the right to make changes in the circuitry and specifications of its devices and advises its customers to obtain the latest version of relevant information.

© AME, Inc. , June 2007

Document: 2006/2095-DS8807-M.01

**Corporate Headquarter**  
**AME, Inc.**

2F, 302 Rui-Guang Road, Nei-Hu District  
Taipei 114, Taiwan, R.O.C.  
Tel : 886 2 2627-8687  
Fax: 886 2 2659-2989

**U.S.A. (Subsidiary)**  
**Analog Microelectronics, Inc.**

3100 De La Cruz Blvd., Suite 201  
Santa Clara, CA. 95054-2438  
Tel : (408) 988-2388  
Fax: (408) 988-2489