



A5A:870.XX

VOLTAGE RATINGS

Part Number	V_{RRM}, V_R (V) Max. rep. peak reverse voltage		V_{RSM}, V_R (V) Max. non-rep. peak reverse voltage
	$T_J = 0$ to 175°C	$T_J = -40$ to 0°C	$T_J = 25$ to 175°C
	A5A:870.24	2400	2400
A5A:870.26	2600	2600	2700
A5A:870.28	2800	2800	2900
A5A:870.30	3000	2900	3100

MAXIMUM ALLOWABLE RATINGS

PARAMETER	VALUE	UNITS	NOTES
T_J Junction Temperature	-40 to 175	$^\circ\text{C}$	-
T_{stg} Storage Temperature	-40 to 175	$^\circ\text{C}$	-
$I_{F(AV)}$ Max. Av. current @ Max. T_C	675	A	180° half sine wave
	125	$^\circ\text{C}$	
$I_{F(RMS)}$ Nom. RMS current	1350	A	-
I_{FSM} Max. Peak non-rep. surge current	10.70	kA	50 Hz half cycle sine wave Initial $T_J = 175^\circ\text{C}$, rated V_{RRM} applied after surge.
	11.67		60 Hz half cycle sine wave
	12.75		50 Hz half cycle sine wave Initial $T_J = 175^\circ\text{C}$, no voltage applied after surge.
	13.90		60 Hz half cycle sine wave
I^2t Max. I^2t capability	523	kA^2s	$t = 10\text{ms}$ Initial $T_J = 175^\circ\text{C}$, rated V_{RRM} applied after surge.
	570		$t = 8.3\text{ms}$
	739		$t = 10\text{ms}$ Initial $T_J = 175^\circ\text{C}$, no voltage applied after surge.
	806		$t = 8.3\text{ms}$
$I^{2,1/2}$ Max. $I^{2,1/2}$ capability	8830	$\text{kA}^2\text{s}^{1/2}$	Initial $T_J = 175^\circ\text{C}$, no voltage applied after surge. I^2t for time $t_x = I^{2,1/2} * t_x^{1/2}$. ($0.1 < t_x < 10\text{ms}$).
F Mounting Force	900	N.m	-



A5A:870.XX

CHARACTERISTICS

PARAMETER	MIN.	TYP.	MAX.	UNITS	TEST CONDITIONS
V _{FM} Peak forward voltage	---	1.75	1.94	V	Initial T _J = 25°C, 50-60Hz half sine, I _{peak} = 2121A.
V _{F(TO)1} Low-level threshold	---	---	0.85	V	T _J = 175°C
V _{F(TO)2} High-level threshold	---	---	0.864		Av. power = V _{F(TO)} * I _{F(AV)} + r _F * [I _{F(RMS)}] ²
r _{F1} Low-level resistance	---	---	0.54	m	Use low values for I _{FM} < I _{F(AV)}
r _{F2} High-level resistance	---	---	0.658		
I _{RM} Peak reverse current	---	15	50	mA	T _J = 175°C. Max. Rated VRRM
R _{thJC} Thermal resistance, junction-to-case	---	---	0.038	°C/W	DC operation, double side
	---	---	0.045	°C/W	180° sine wave, double side
	---	---	0.046	°C/W	120° rectangular wave, duble side
R _{thCS} Thermal resistance, case-to-sink	---	---	0.02	°C/W	Mtg. Surface smooth, flat and greased. Double side.
wt Weight	---	85(3.0)	---	g(oz.)	---
Case Style	TO-200AB			JEDEC	---

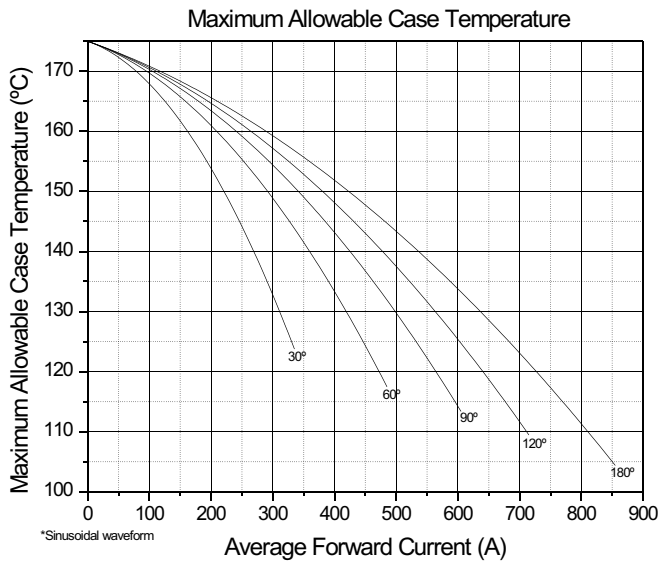

Fig. 1 - Current Ratings Characteristics

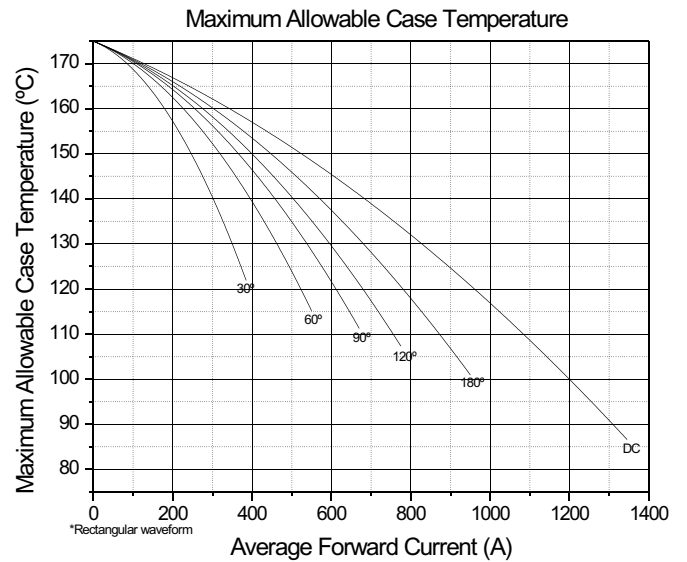

Fig. 2 - Current Ratings Characteristics



A5A:870.XX

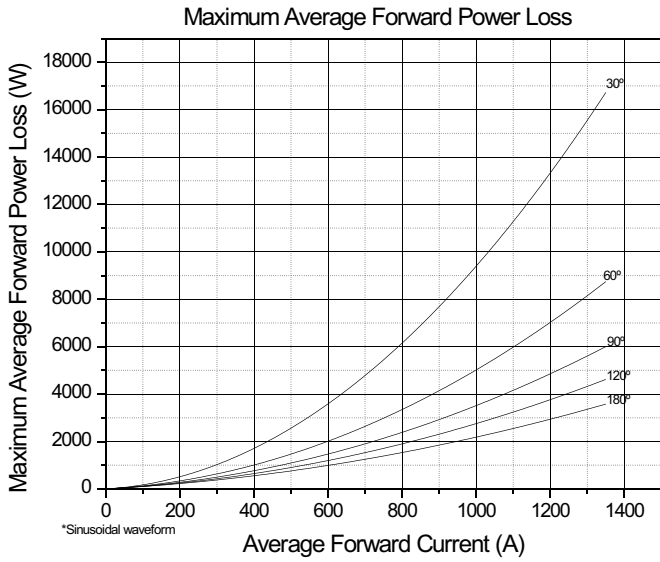

Fig. 3 - On-State Power Loss Characteristics

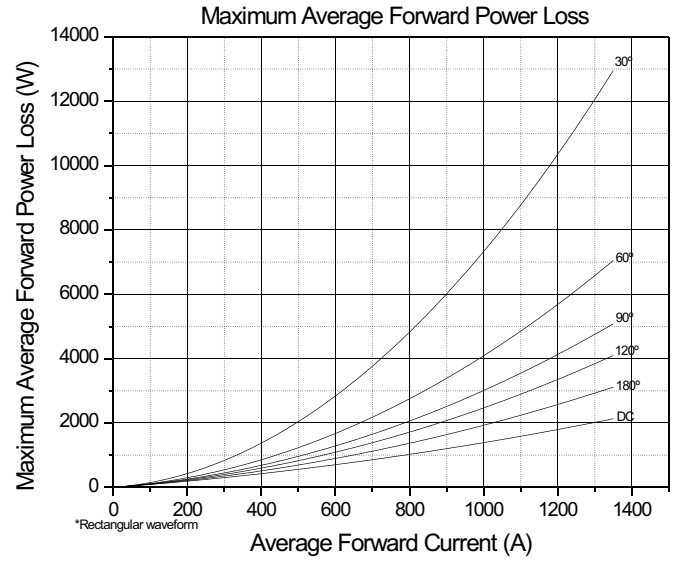

Fig. 4 - On-State Power Loss Characteristics

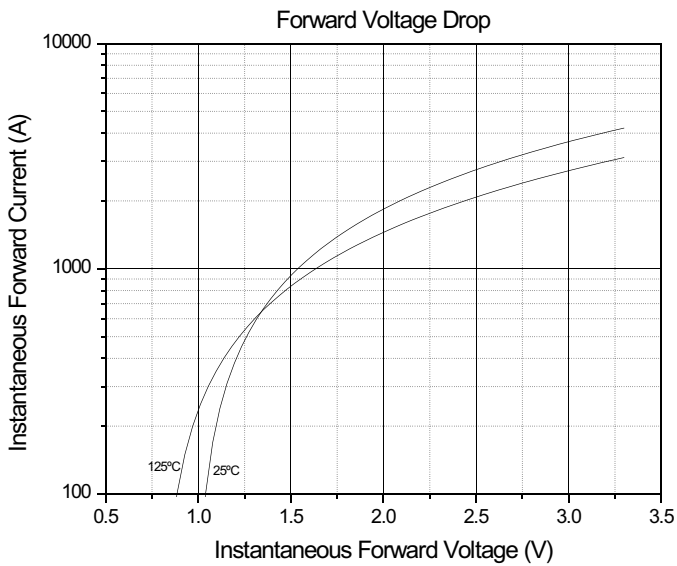

Fig. 5 - Forward Voltage Drop Characteristics

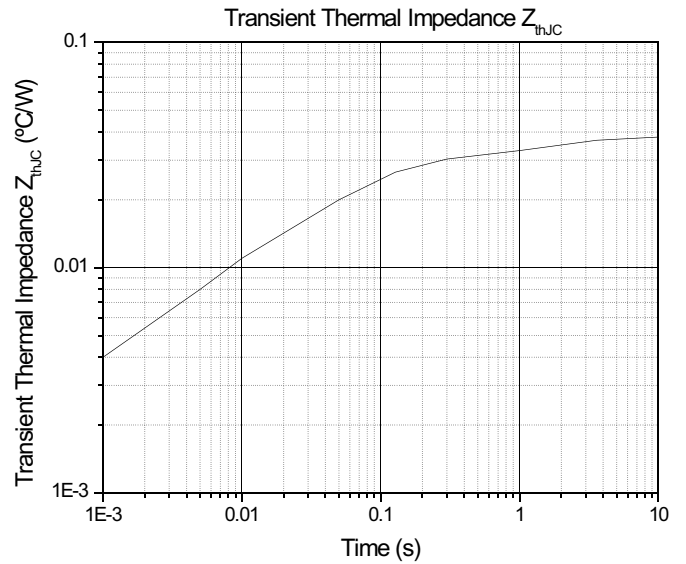

Fig. 6 - Transient Thermal Impedance Characteristics



A5A:870.XX

TO-200AB

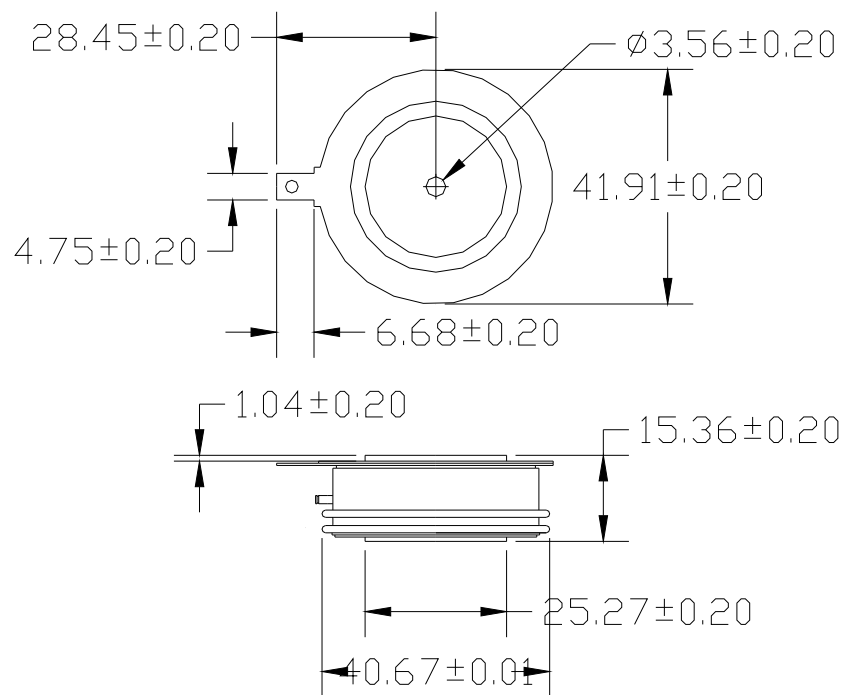

Fig. 7 - Outline Characteristics