



## A5A:3200.XX

### VOLTAGE RATINGS

Part Number	$V_{RRM}, V_R$ (V) Max. rep. peak reverse voltage		$V_{RSM}, V_R$ (V) Max. non-rep. peak reverse voltage
	$T_J = 0$ to $175^\circ\text{C}$	$T_J = -40$ to $0^\circ\text{C}$	$T_J = 25$ to $175^\circ\text{C}$
	A5A:3200.24	2400	2400
A5A:3200.26	2600	2600	2700
A5A:3200.28	2800	2800	2900
A5A:3200.30	3000	3000	3100
A5A:3200.32	3200	3200	3300
A5A:3200.34	3400	3400	3500
A5A:3200.36	3600	3600	3700
A5A:3200.38	3800	3800	3900
A5A:3200.40	4000	4000	4100
A5A:3200.42	4200	4200	4300

### MAXIMUM ALLOWABLE RATINGS

PARAMETER	VALUE	UNITS	NOTES
$T_J$ Junction Temperature	-40 to 175	$^\circ\text{C}$	-
$T_{stg}$ Storage Temperature	-40 to 175	$^\circ\text{C}$	-
$I_{F(AV)}$ Max. Av. current @ Max. $T_C$	3200	A	180° half sine wave
	100	$^\circ\text{C}$	
$I_{F(RMS)}$ Nom. RMS current	5040	A	-
$I_{FSM}$ Max. Peak non-rep. surge current	39.5	kA	50 Hz half cycle sine wave Initial $T_J = 175^\circ\text{C}$ , rated $V_{RRM}$ applied after surge.
	43.0		60 Hz half cycle sine wave
	46.9		50 Hz half cycle sine wave Initial $T_J = 175^\circ\text{C}$ , no voltage applied after surge.
	51.1		60 Hz half cycle sine wave
$I^2t$ Max. $I^2t$ capability	7064	$\text{kA}^2\text{s}$	$t = 10\text{ms}$ Initial $T_J = 175^\circ\text{C}$ , rated $V_{RRM}$ applied after surge.
	7700		$t = 8.3\text{ms}$
	9917		$t = 10\text{ms}$ Initial $T_J = 175^\circ\text{C}$ , no voltage applied after surge.
	10810		$t = 8.3\text{ms}$
$I^2t^{1/2}$ Max. $I^2t^{1/2}$ capability	119000	$\text{kA}^2\text{s}^{1/2}$	Initial $T_J = 175^\circ\text{C}$ , no voltage applied after surge. for time $t_x = I^2t^{1/2} * t_x^{1/2}$ . ( $0.1 < t_x < 10\text{ms}$ ).
F Mounting Force	4550	N.m	-



# A5A:3200.XX

## CHARACTERISTICS

PARAMETER	MIN.	TYP.	MAX.	UNITS	TEST CONDITIONS
V <sub>FM</sub> Peak forward voltage	---	---	1.89	V	Initial T <sub>J</sub> = 25°C, 50-60Hz half sine, I <sub>beak</sub> = 10053A.
V <sub>F(TO)1</sub> Low-level threshold	---	---	1.186	V	T <sub>J</sub> = 175°C
V <sub>F(TO)2</sub> High-level threshold	---	---	1.139		Av. power = V <sub>F(TO)</sub> * I <sub>F(AV)</sub> + r <sub>F</sub> * [I <sub>F(RMS)</sub> ] <sup>2</sup>
r <sub>F1</sub> Low-level resistance	---	---	0.109	m	Use low values for I <sub>FM</sub> < I <sub>F(AV)</sub>
r <sub>F2</sub> High-level resistance	---	---	0.145		
I <sub>RM</sub> Peak reverse current	---	---	225	mA	T <sub>J</sub> = 175°C. Max. Rated V <sub>RRM</sub>
R <sub>thJC</sub> Thermal resistance, junction-to-case	---	---	0.011	°C/W	DC operation, double side
	---	---	0.012	°C/W	180° sine wave, double side
	---	---	0.012	°C/W	120° rectangular wave, duple side
R <sub>thCS</sub> Thermal resistance, case-to-sink	---	---	0.006	°C/W	Mtg. Surface smooth, flat and greased.
wt Weight	---	1590(56)	---	g(oz.)	---
Case Style	"IR B-44"			-	---

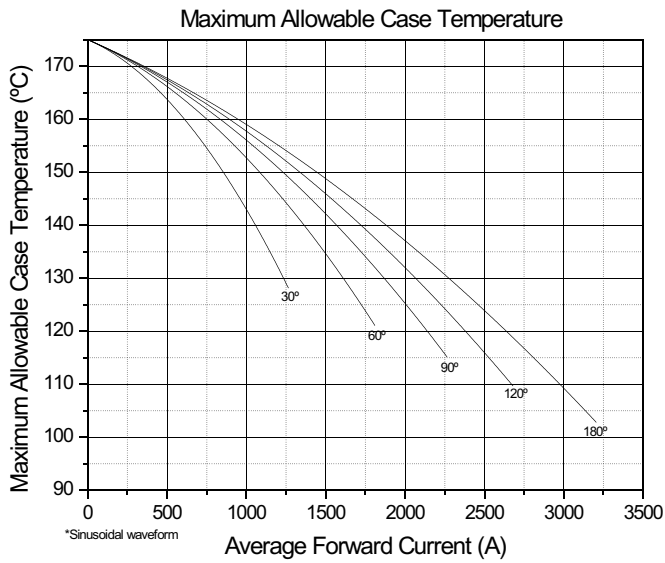

Fig. 1 - Current Ratings Characteristics

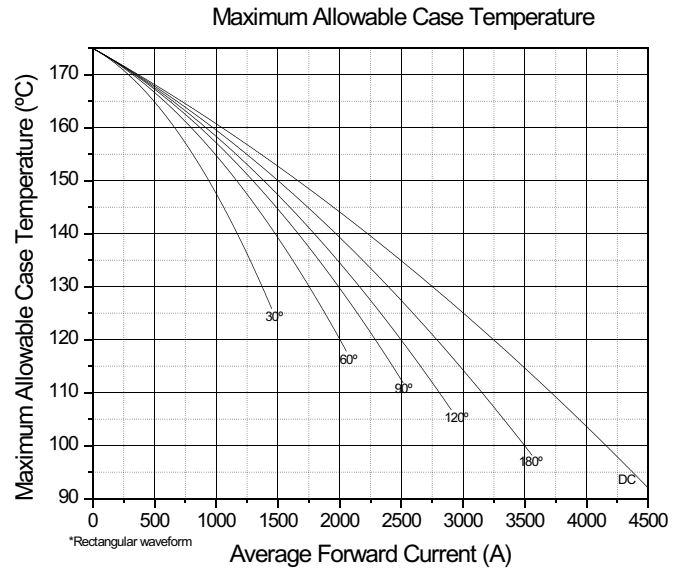
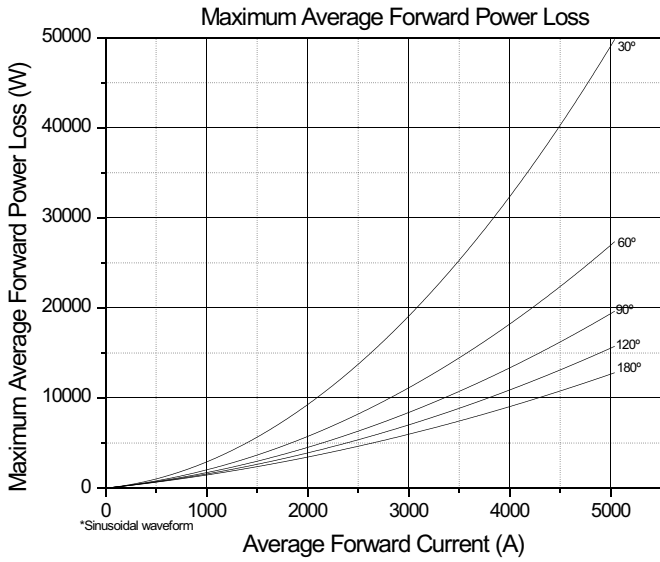

Fig. 2 - Current Ratings Characteristics



## A5A:3200.XX



**Fig. 3 - Average Forward Power Loss Characteristics**

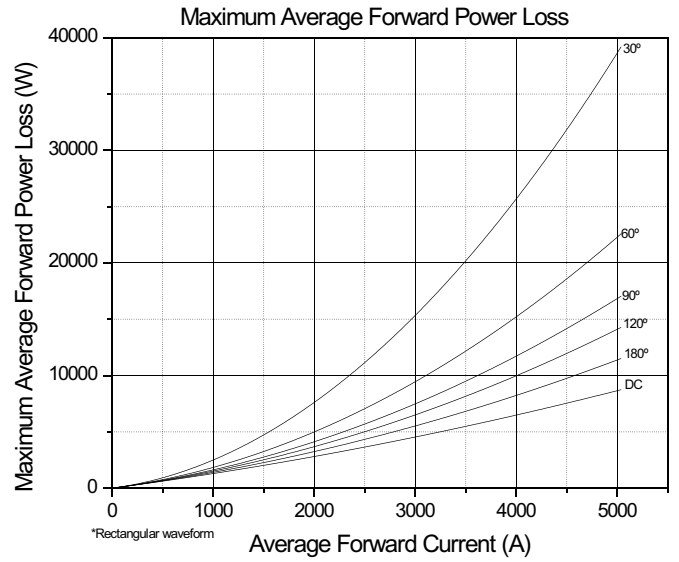

**Fig. 4 - Average Forward Power Loss Characteristics**

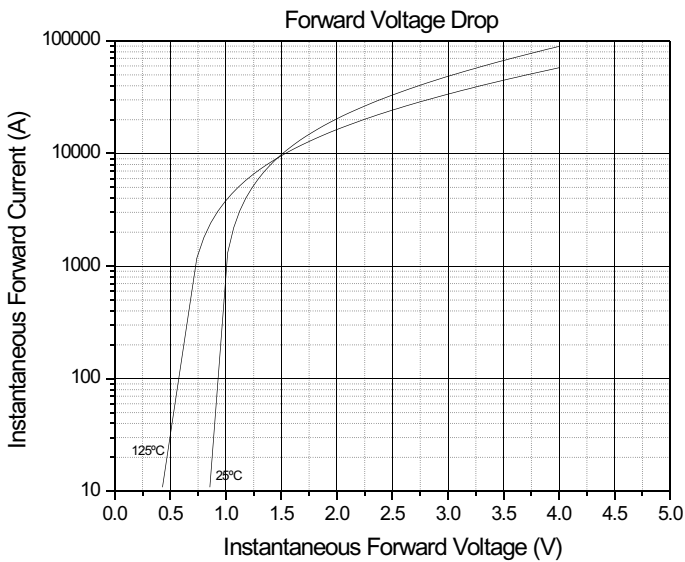

**Fig. 5 - Forward Voltage Drop Characteristics**

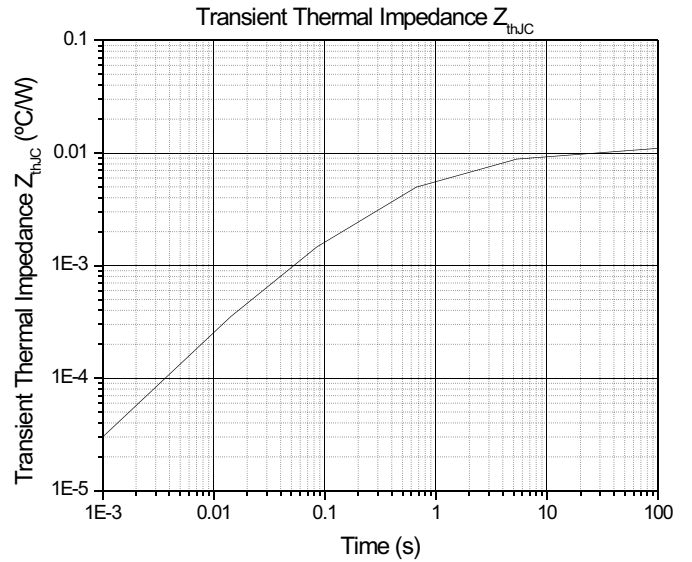
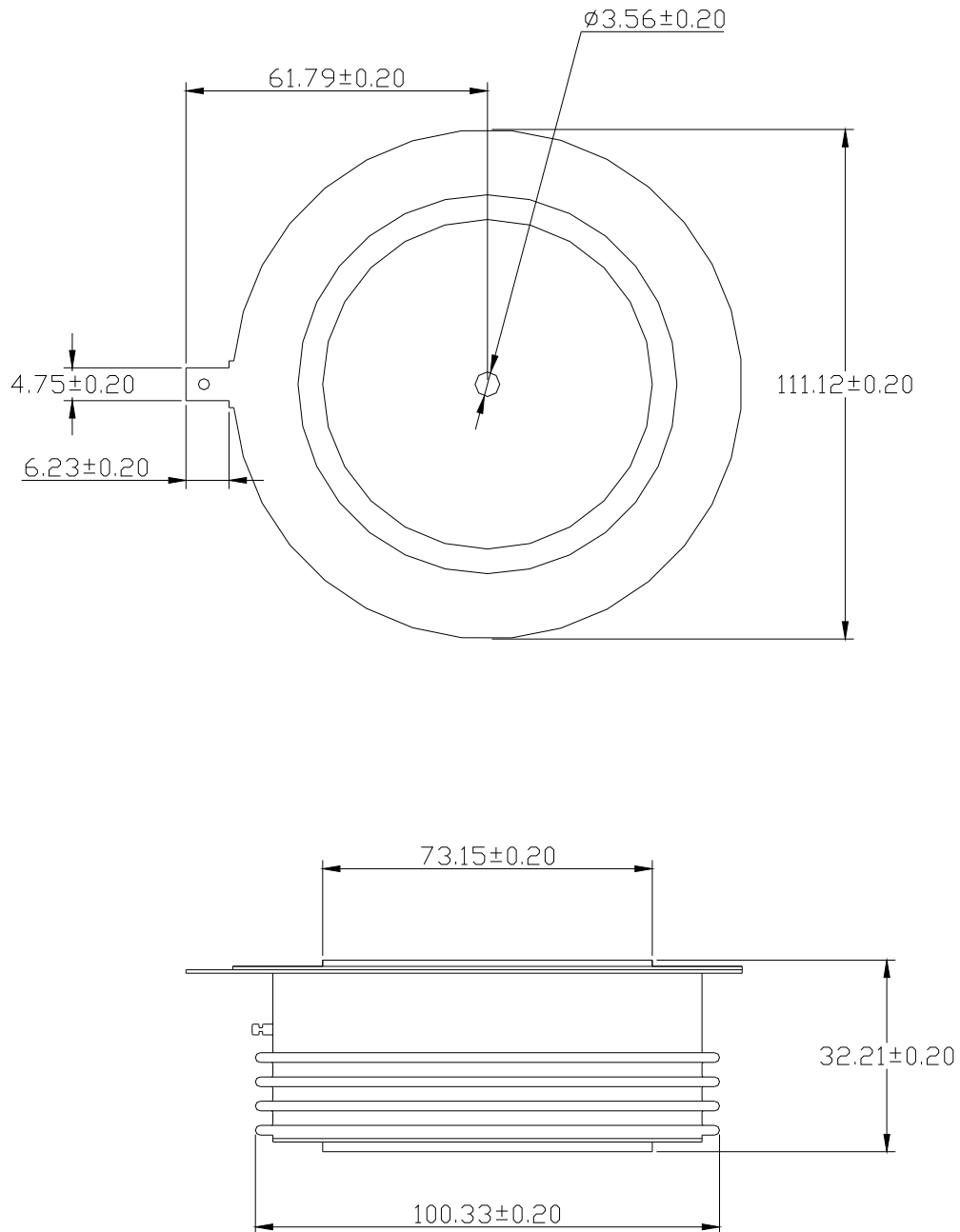

**Fig. 6 - Transient Thermal Impedance  $Z_{thJC}$  Characteristics**



## A5A:3200.XX

“B-44”



**Fig. 7 - Outline Characteristics**