



MOTOROLA

MRF401

The RF Line

NPN SILICON RF POWER TRANSISTORS

... designed primarily for applications as a high-power linear amplifier from 2.0 to 75 MHz.

- Specified 28 Volt, 30 MHz Characteristics –
Output Power = 25 W (PEP)
Minimum Gain = 13 dB
Efficiency = 40%
- Intermodulation Distortion at 25 W (PEP)
IMD = -32 dB (Max)
- Isothermal-Resistor Design Results in Rugged Device

**25 W PEP – 30 MHz
RF POWER
TRANSISTOR
NPN SILICON**

3

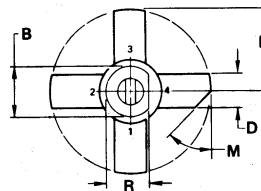
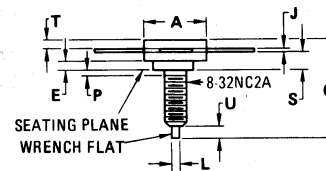
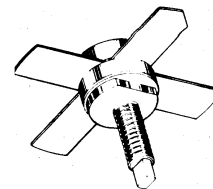

STYLE 1:
PIN 1. EMITTER
2. BASE
3. EMITTER
4. COLLECTOR

MAXIMUM RATINGS

Rating	Symbol	Value	Unit
Collector-Emitter Voltage	V _{CEO}	30	Vdc
Emitter-Base Voltage	V _{EBO}	4.0	Vdc
Collector Current – Continuous	I _C	3.3	Adc
Total Device Dissipation @ T _C = 25°C(1) Derate above 25°C	P _D	50 28.6	Watts W/°C
Storage Temperature Range	T _{stg}	-65 to +200	°C

DIM	MILLIMETERS		INCHES	
	MIN	MAX	MIN	MAX
A	9.40	9.78	0.370	0.385
B	8.13	8.38	0.320	0.330
C	17.02	20.07	0.670	0.790
D	5.46	5.97	0.215	0.235
E	1.78	—	0.070	—
J	0.08	0.18	0.003	0.007
K	12.45	—	0.490	—
L	1.40	1.78	0.055	0.070
M	—	45° NOM	—	45° NOM
P	—	1.27	—	0.050
R	7.59	7.80	0.299	0.307
S	4.01	4.52	0.158	0.178
T	2.11	2.54	0.083	0.100
U	2.49	3.35	0.098	0.132

(1) These devices are designed for RF operation. The total device dissipation rating applies only when the devices are operated as class B or C RF amplifiers.

145A-09

MRF401

3

ELECTRICAL CHARACTERISTICS ($T_C = 25^\circ\text{C}$ unless otherwise noted.)

Characteristic	Symbol	Min	Typ	Max	Unit
OFF CHARACTERISTICS					
Collector-Emitter Breakdown Voltage ($I_C = 50 \text{ mA dc}, I_B = 0$)	BV_{CEO}	30	—	—	Vdc
Collector-Emitter Breakdown Voltage ($I_C = 10 \text{ mA dc}, V_{BE} = 0$)	BV_{CES}	60	—	—	Vdc
Emitter-Base Breakdown Voltage ($I_E = 10 \text{ mA dc}, I_C = 0$)	BV_{EBO}	4.0	—	—	Vdc
ON CHARACTERISTICS					
DC Current Gain ($I_C = 1.0 \text{ A dc}, V_{CE} = 5.0 \text{ V dc}$)	h_{FE}	10	20	—	—
DYNAMIC CHARACTERISTICS					
Output Capacitance ($V_{CB} = 30 \text{ V dc}, I_E = 0, f = 1.0 \text{ MHz}$)	C_{ob}	—	65	85	pF
FUNCTIONAL TEST (Figure 1)					
Common-Emitter Amplifier Power Gain ($P_{out} = 25 \text{ Watts PEP}, I_C (\text{max}) = 1.12 \text{ A dc}, V_{CC} = 28 \text{ V dc}, f = 30 \text{ MHz}$)	G_{PE}	13	—	—	dB
Collector Efficiency ($P_{out} = 25 \text{ Watts PEP}, I_C (\text{max}) = 1.12 \text{ A dc}, V_{CC} = 28 \text{ V dc}, f = 30 \text{ MHz}$)	η	40	—	—	%
Intermodulation Distortion ($P_{out} = 25 \text{ Watts PEP}, I_C = 1.12 \text{ A dc}, V_{CC} = 28 \text{ V dc}, f_1 = 30 \text{ MHz}, f_2 = 30.001 \text{ MHz}$)	IM	—	—	-32	dB

FIGURE 1 — 30 MHz LINEAR TEST CIRCUIT

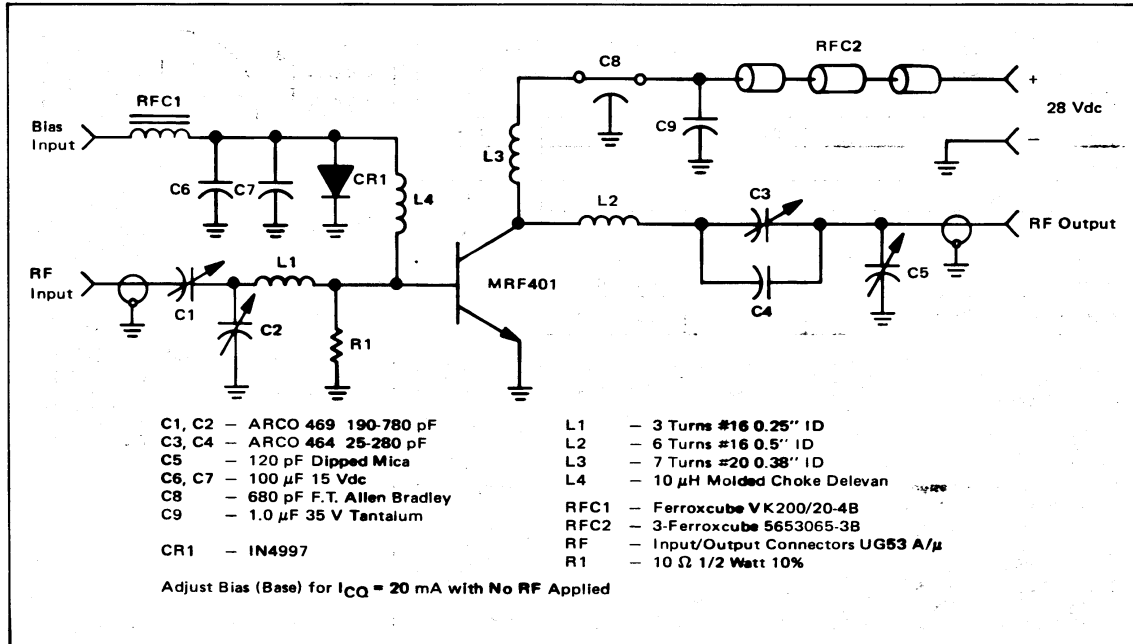

FIGURE 2 – PARALLEL EQUIVALENT INPUT RESISTANCE versus FREQUENCY

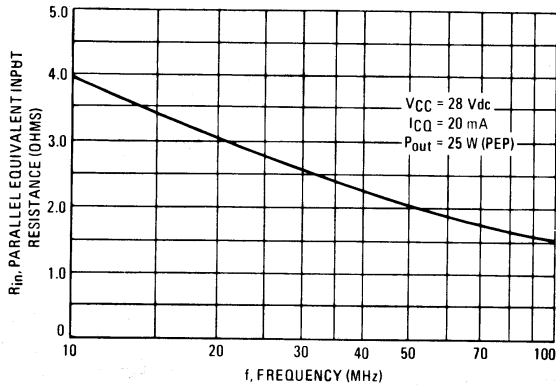

FIGURE 3 – PARALLEL EQUIVALENT INPUT CAPACITANCE versus FREQUENCY

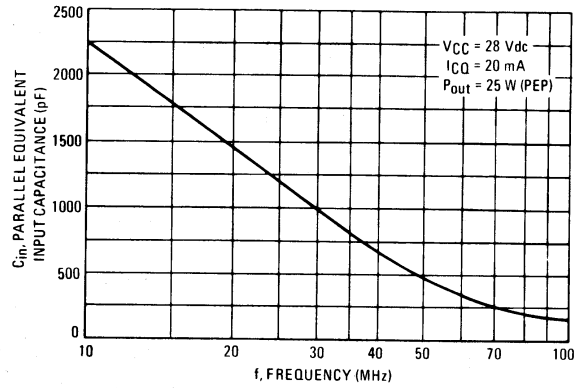

FIGURE 4 – PARALLEL EQUIVALENT OUTPUT CAPACITANCE versus FREQUENCY

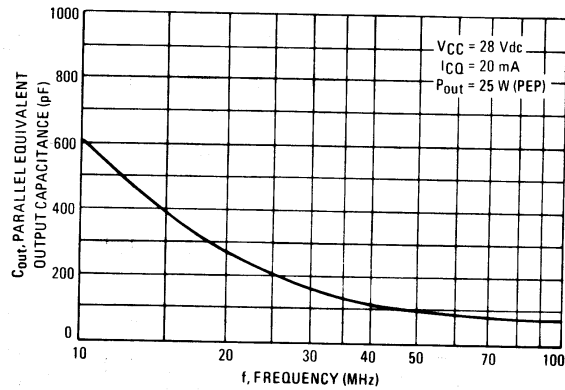

FIGURE 5 – POWER GAIN versus FREQUENCY

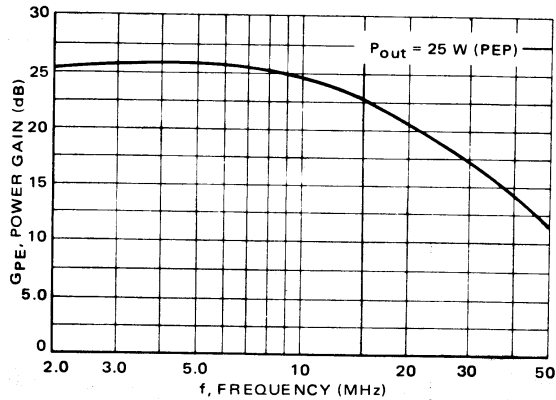

FIGURE 6 – IMD versus POWER OUTPUT

