

8-bit Proprietary Microcontrollers

CMOS

F²MC-8FX MB95100B Series

**MB95107B/F108BS/F108BW/R107B/D108BS/
MB95D108BW/FV100D-101**

■ DESCRIPTION

The MB95100B series is general-purpose, single-chip microcontrollers. In addition to a compact instruction set, the microcontrollers contain a variety of peripheral functions.

Note : F²MC is the abbreviation of FUJITSU Flexible Microcontroller.

■ FEATURE

- F²MC-8FX CPU core
 - Instruction set optimized for controllers
 - Multiplication and division instructions
 - 16-bit arithmetic operations
 - Bit test branch instruction
 - Bit manipulation instructions etc.
- Clock
 - Main clock
 - Main PLL clock
 - Sub clock (for dual clock product)
 - Sub PLL clock (for dual clock product)

(Continued)

Be sure to refer to the “Check Sheet” for the latest cautions on development.

“Check Sheet” is seen at the following support page

URL : <http://www.fujitsu.com/global/services/microelectronics/product/micom/support/index.html>

“Check Sheet” lists the minimal requirement items to be checked to prevent problems beforehand in system development.

MB95100B Series

(Continued)

- Timer
 - 8/16-bit compound timer × 2 channels
 - 16-bit reload timer
 - 8/16-bit PPG × 2 channels
 - 16-bit PPG × 2 channels
 - Timebase timer
 - Watch prescaler (for dual clock product)
- FRAM
 - 2K bytes FRAM is loaded (MB95R107B/MB95D108BS/MB95D108BW only)
- LIN-UART
 - Full duplex double buffer
 - Clock asynchronous (UART) or clock synchronous (SIO) serial data transfer capable
- UART/SIO
 - Full duplex double buffer
 - Clock asynchronous (UART) or clock synchronous (SIO) serial data transfer capable
- I²C*
 - Built-in wake-up function
- External interrupt
 - Interrupt by edge detection (rising, falling, or both edges can be selected)
 - Can be used to recover from low-power consumption (standby) modes.
- 8/10-bit A/D converter
 - 8-bit or 10-bit resolution can be selected.
- Low-power consumption (standby) mode
 - Stop mode
 - Sleep mode
 - Watch mode (for dual clock product)
 - Timebase timer mode
- I/O port
 - The number of maximum ports
 - Single clock product : 55 ports
 - Dual clock product : 53 ports
 - Port configuration
 - General-purpose I/O ports (N-ch open drain)
 - Other than MB95D108BS/MB95D108BW/MB95R107B : 6 ports
 - MB95D108BS/MB95D108BW/MB95R107B : 4 ports
 - General-purpose I/O ports (CMOS)
 - Single clock product : 49 ports
 - Dual clock product : 47 ports

* : Purchase of Fujitsu I²C components conveys a license under the Philips I²C Patent Rights to use, these components in an I²C system provided that the system conforms to the I²C Standard Specification as defined by Philips.

MB95100B Series

■ PRODUCT LINEUP

Part number		MB95107B	MB95F108BS/ MB95F108BW	MB95R107B*3	MB95D108BS/ MB95D108BW
Parameter					
Type		MASK ROM product	Flash memory product	MASK ROM product	Flash memory product
ROM capacity		48K bytes	60K bytes	48K bytes	60K bytes
RAM capacity		2K bytes			
FRAM capacity		No		2K bytes	
Reset output		No			
Option*4	Clock system	Selectable Single/Dual clock*1	Single/Dual clock*2	Selectable Single/Dual clock*1	Single/Dual clock*2
	Low voltage detection reset	No			
CPU functions		Number of basic instructions : 136 Instruction bit length : 8 bits Instruction length : 1 to 3 bytes Data bit length : 1, 8, and 16 bits Minimum instruction execution time : 61.5 ns (at machine clock frequency 16.25 MHz) Interrupt processing time : 0.6 μs (at machine clock frequency 16.25 MHz)			
Peripheral functions	General purpose I/O ports	<ul style="list-style-type: none"> • Single clock product : 55 ports (N-ch open drain *5 : 4/6 ports, CMOS : 49 ports) • Dual clock product : 53 ports (N-ch open drain *5 : 4/6 ports, CMOS : 47 ports) 			
	Timebase timer	Interrupt cycle : 0.5 ms, 2.1 ms, 8.2 ms, 32.8 ms (at main oscillation clock 4 MHz)			
	Watchdog timer	Reset generated cycle At main oscillation clock 10 MHz : Min 105 ms At sub oscillation clock 32.768 kHz (for dual clock product) : Min 250 ms			
	Wild register	Capable of replacing 3 bytes of ROM data			
	I ² C	Master/slave sending and receiving Bus error function and arbitration function Detecting transmitting direction function Start condition repeated generation and detection functions Built-in wake-up function			
	UART/SIO	Data transfer capable in UART/SIO Full duplex double buffer, Variable data length (5/6/7/8-bit), built-in baud rate generator NRZ type transfer format, error detected function LSB-first or MSB-first can be selected. Clock asynchronous (UART) or clock synchronous (SIO) serial data transfer capable			
	LIN-UART	Dedicated reload timer allowing a wide range of communication speeds to be set. Full duplex double buffer. Clock asynchronous (UART) or clock synchronous (SIO) serial data transfer capable LIN functions available as the LIN master or LIN slave.			
8/10-bit A/D converter (12 channels)	8-bit or 10-bit resolution can be selected.				

(Continued)

MB95100B Series

(Continued)

Part number		MB95107B	MB95F108BS/ MB95F108BW	MB95R107B*3	MB95D108BS/ MB95D108BW
Parameter					
Peripheral functions	16-bit reload timer	Two clock modes and two counter operating modes can be selected. Square wave form output Count clock : 7 internal clocks and external clock can be selected. Counter operating mode : reload mode or one-shot mode can be selected.			
	8/16-bit compound timer (2 channels)	Each channel of the timer can be used as “8-bit timer × 2 channels” or “16-bit timer × 1 channel”. Built-in timer function, PWC function, PWM function, capture function and square wave form output Count clock : 7 internal clocks and external clock can be selected.			
	16-bit PPG (2 channels)	PWM mode or one-shot mode can be selected. Counter operating clock : Eight selectable clock sources Support for external trigger start			
	8/16-bit PPG (2 channels)	Each channel of the PPG can be used as “8-bit PPG × 2 channels” or “16-bit PPG × 1 channel”. Counter operating clock : Eight selectable clock sources			
	Watch counter (for dual clock product)	Count clock : Four selectable clock sources (125 ms, 250 ms, 500 ms, or 1 s) Counter value can be set from 0 to 63. (Capable of counting for 1 minute when selecting clock source 1 second and setting counter value to 60)			
	Watch prescaler (for dual clock product)	4 selectable interval times (125 ms, 250 ms, 500 ms, or 1 s)			
	External interrupt (12 channels)	Interrupt by edge detection (rising, falling, or both edges can be selected.) Can be used to recover from standby modes.			
	Flash memory	Supports automatic programming, Embedded Algorithm™*6 Write/Erase/Erase-Suspend/Resume commands A flag indicating completion of the algorithm Number of write/erase cycles (Minimum) : 10000 times Data retention time : 20 years Erase can be performed on each block Boot block configuration Block protection with external programming voltage Flash Security Feature for protecting the content of the Flash			
Standby mode	Sleep, stop, watch (for dual clock product), and timebase timer				

*1 : Specify clock mode when ordering MASK ROM.

*2 : MB95F108BS/MB95D108BS is single clock and MB95F108BW/MB95D108BW is dual clock.

*3 : This device is under development.

*4 : For details of option, refer to “■ MASK OPTION”.

*5 : MB95D108BS/D108BW/R107B contain 4 general-purpose I/O ports for N-ch open drain. Port number other than MB95D108BS/D108BW/R107B has 6 general-purpose I/O ports for N-ch open drain.

*6 : Embedded Algorithm is a trade mark of Advanced Micro Devices Inc.

Note : Part number of the evaluation products in MB95100B series is MB95FV100D-101. When using it, the MCU board (MB2146-301A) is required.

MB95100B Series

■ SELECT OF OSCILLATION STABILIZATION WAIT TIME (MASK ROM PRODUCT ONLY)

For the MASK ROM product, you can set the mask option when ordering MASK ROM to select the initial value of main clock oscillation stabilization wait time from among the following four values.

Note that the evaluation and Flash memory products are fixed their initial value of main clock oscillation stabilization wait time at the maximum value.

Select of oscillation stabilization wait time	Remarks
$(2^2 - 2) / F_{CH}$	0.5 μ s (at main oscillation clock 4 MHz)
$(2^{12} - 2) / F_{CH}$	Approx. 1.02 ms (at main oscillation clock 4 MHz)
$(2^{13} - 2) / F_{CH}$	Approx. 2.05 ms (at main oscillation clock 4 MHz)
$(2^{14} - 2) / F_{CH}$	Approx. 4.10 ms (at main oscillation clock 4 MHz)

■ PACKAGES AND CORRESPONDING PRODUCTS

Part number Package	MB95107B MB95R107B	MB95F108BS/F108BW MB95D108BS/D108BW	MB95FV100D-101
FPT-64P-M03	○	○	×
FPT-64P-M09	○	○	×
BGA-224P-M08	×	×	○

- : Available
 × : Unavailable

MB95100B Series

■ DIFFERENCES AMONG PRODUCTS AND NOTES ON SELECTING PRODUCTS

• Notes on Using Evaluation Products

The evaluation product has not only the functions of the MB95100B series but also those of other products to support software development for multiple series and models of the F²MC-8FX family. The I/O addresses for peripheral resources not used by the MB95100B series are therefore access-barred. Read/write access to these access-barred addresses may cause peripheral resources supposed to be unused to operate, resulting in unexpected malfunctions of hardware or software.

Particularly, do not use word access to odd numbered byte address in the prohibited areas (If these access are used, the address may be read or written unexpectedly).

Also, as the read values of prohibited addresses on the evaluation product are different to the values on the Flash memory and MASK ROM products, do not use these values in the program.

The evaluation product do not support the functions of some bits in single-byte registers. Read/write access to these bits does not cause hardware malfunctions. The evaluation, Flash memory, and MASK ROM products are designed to behave completely the same way in terms of hardware and software.

• Difference of Memory Spaces

If the amount of memory on the evaluation product is different from that of the Flash memory or MASK ROM product, carefully check the difference in the amount of memory from the model to be actually used when developing software.

For details of memory space, refer to “■ CPU CORE”.

• Current Consumption

The current consumption of Flash memory product is greater than for MASK ROM product.
For details of current consumption, refer to “■ ELECTRICAL CHARACTERISTICS”.

• Package

For details of information on each package, refer to “■ PACKAGES AND CORRESPONDING PRODUCTS” and “■ PACKAGE DIMENSIONS”.

• Operating voltage

The operating voltage are different among the evaluation, Flash memory, and MASK ROM products.

For details of operating voltage, refer to “■ ELECTRICAL CHARACTERISTICS”.

• Difference between \overline{RST} and MOD pins

The input type of \overline{RST} and MOD pins is CMOS input on the Flash memory product. The \overline{RST} and MOD pins are hysteresis inputs on the MASK ROM product. A pull - down resistor is provided for the MOD pin of the MASK ROM product.

■ PIN ASSIGNMENT

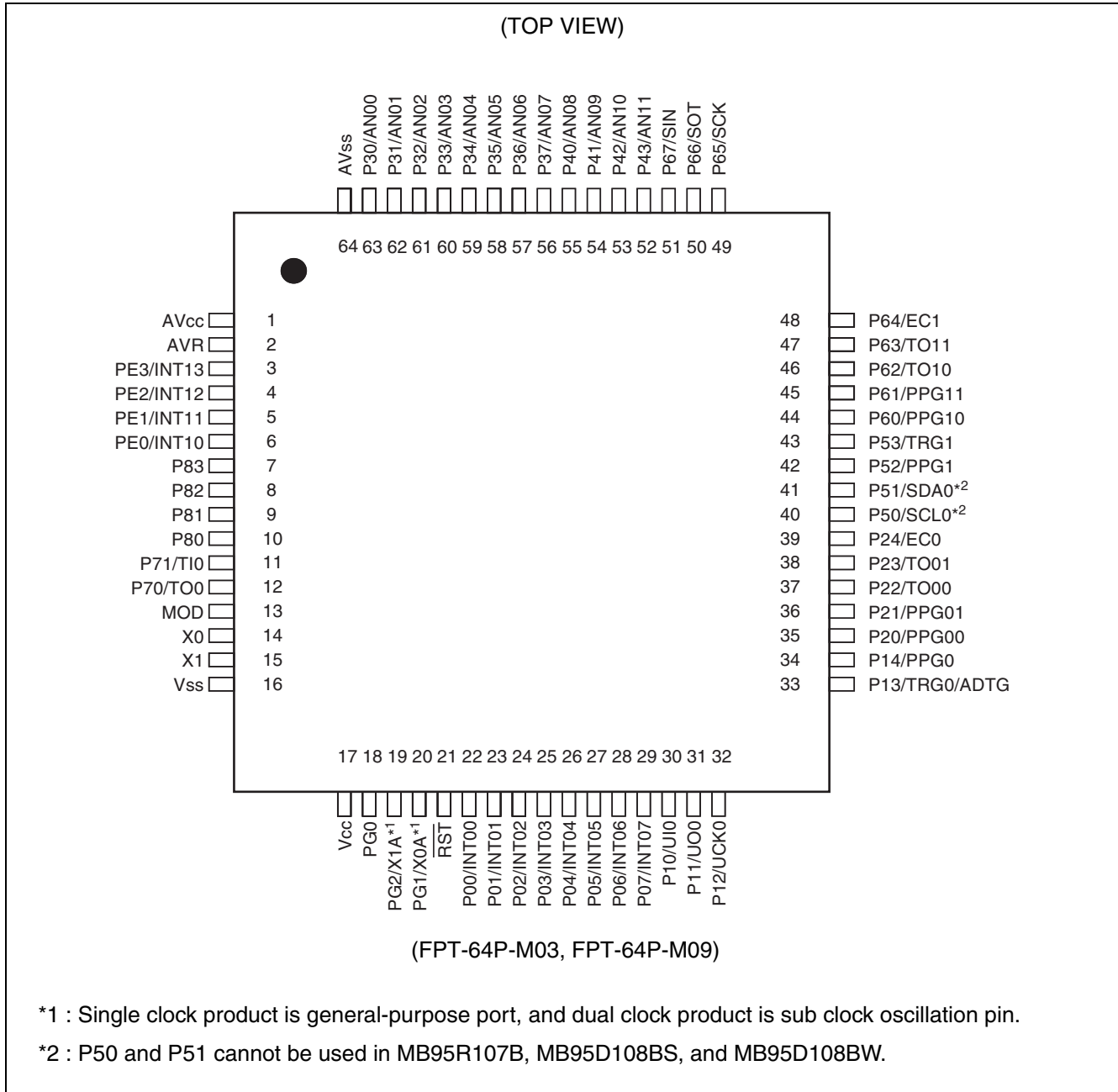

MB95100B Series

■ PIN DESCRIPTION

Pin no.	Pin name	I/O circuit type*	Function
1	AV _{cc}	—	A/D converter power supply pin
2	AVR	—	A/D converter reference input pin
3	PE3/INT13	P	General-purpose I/O port The pins are shared with the external interrupt input.
4	PE2/INT12		
5	PE1/INT11		
6	PE0/INT10		
7	P83	O	General-purpose I/O port
8	P82		
9	P81		
10	P80		
11	P71/TI0	H	General-purpose I/O port. The pin is shared with 16 - bit reload timer ch.0 input.
12	P70/TO0		General-purpose I/O port. The pin is shared with 16 - bit reload timer ch.0 output.
13	MOD	B	An operating mode designation pin
14	X0	A	Main clock input oscillation pin
15	X1		Main clock input/output oscillation pin
16	V _{ss}	—	Power supply pin (GND)
17	V _{cc}	—	Power supply pin
18	PG0	H	General-purpose I/O port.
19	PG2/X1A	H/A	Single-system product is general-purpose port (PG2). Dual-system product is sub clock input/output oscillation pin (32 kHz).
20	PG1/X0A		Single-system product is general-purpose port (PG1). Dual-system product is sub clock input oscillation pin (32 kHz).
21	$\overline{\text{RST}}$	B'	Reset pin
22	P00/INT00	C	General-purpose I/O port. The pins are shared with external interrupt input. Large current port.
23	P01/INT01		
24	P02/INT02		
25	P03/INT03		
26	P04/INT04		
27	P05/INT05		
28	P06/INT06		
29	P07/INT07		
30	P10/UI0	G	General-purpose I/O port. The pin is shared with UART/SIO ch.0 data input.

(Continued)

MB95100B Series

Pin no.	Pin name	I/O circuit type*	Function
31	P11/UO0	H	General-purpose I/O port. The pin is shared with UART/SIO ch.0 data output.
32	P12/UCK0		General-purpose I/O port. The pin is shared with UART/SIO ch.0 clock I/O.
33	P13/TRG0/ ADTG		General-purpose I/O port. The pin is shared with 16-bit PPG ch.0 trigger input (TRG0) and A/D converter trigger input (ADTG).
34	P14/PPG0		General-purpose I/O port. The pin is shared with 16-bit PPG ch.0 output.
35	P20/PPG00	H	General-purpose I/O port. The pins are shared with 8/16-bit PPG ch.0 output.
36	P21/PPG01		General-purpose I/O port. The pins are shared with 8/16-bit compound timer ch.0 output.
37	P22/TO00		
38	P23/TO01		
39	P24/EC0		General-purpose I/O port. The pin is shared with 8/16-bit compound timer ch.0 clock input.
40	P50/SCL0	I	General-purpose I/O port (Except MB95R107B , MB95D108BS, and MB95D108BW) . The pin is shared with I ² C ch.0 clock I/O.
41	P51/SDA0		General-purpose I/O port (Except MB95R107B, MB95D108BS, and MB95D108BW) . The pin is shared with I ² C ch.0 data I/O.
42	P52/PPG1	H	General-purpose I/O port. The pin is shared with 16-bit PPG ch.1 output.
43	P53/TRG1		General-purpose I/O port. The pin is shared with 16-bit PPG ch.1 trigger input.
44	P60/PPG10	K	General-purpose I/O port. The pins are shared with 8/16-bit PPG ch.1 output.
45	P61/PPG11		General-purpose I/O port. The pins are shared with 8/16-bit compound timer ch.1 output.
46	P62/TO10		
47	P63/TO11		General-purpose I/O port. The pin is shared with 8/16-bit compound timer ch.1 clock input.
48	P64/EC1		
49	P65/SCK		
50	P66/SOT		General-purpose I/O port. The pin is shared with LIN-UART data output.
51	P67/SIN	L	General-purpose I/O port. The pin is shared with LIN-UART data input.

(Continued)

MB95100B Series

(Continued)

Pin no.	Pin name	I/O circuit type*	Function
52	P43/AN11	J	General-purpose I/O port. The pins are shared with A/D converter analog input.
53	P42/AN10		
54	P41/AN09		
55	P40/AN08		
56	P37/AN07	J	General-purpose I/O port. The pins are shared with A/D converter analog input.
57	P36/AN06		
58	P35/AN05		
59	P34/AN04		
60	P33/AN03		
61	P32/AN02		
62	P31/AN01		
63	P30/AN00		
64	AV _{SS}	—	A/D converter power supply pin (GND)

* : For the I/O circuit type, refer to “■ I/O CIRCUIT TYPE”.

■ I/O CIRCUIT TYPE

Type	Circuit	Remarks
A		<ul style="list-style-type: none"> • Oscillation circuit • High-speed side Feedback resistance value : approx. 1 MΩ • Low-speed side Feedback resistance : approx. 24 MΩ (Evaluation product : approx. 10 MΩ) Dumping resistance : approx. 144 kΩ (Evaluation product : without dumping resistance)
B		<ul style="list-style-type: none"> • Only for input • Hysteresis input only for MASK ROM product • With pull-down resistor only for MASK ROM product
B'		<ul style="list-style-type: none"> • Hysteresis input only for MASK ROM product
C		<ul style="list-style-type: none"> • CMOS output • Hysteresis input
G		<ul style="list-style-type: none"> • CMOS output • CMOS input • Hysteresis input • With pull-up control
H		<ul style="list-style-type: none"> • CMOS output • Hysteresis input • With pull-up control

(Continued)

MB95100B Series

Type	Circuit	Remarks
I	<p>Standby control</p> <p>P-ch</p> <p>N-ch</p> <p>Digital output</p> <p>CMOS input</p> <p>Hysteresis input</p>	<ul style="list-style-type: none"> • N-ch open drain output • CMOS input • Hysteresis input • P-ch transistor is existed in MB95D108BS, MB95D108BW, and MB95R107B.
J	<p>R</p> <p>P-ch</p> <p>P-ch</p> <p>N-ch</p> <p>Pull-up control</p> <p>Digital output</p> <p>Digital output</p> <p>Analog input</p> <p>A/D control</p> <p>Standby control</p> <p>Hysteresis input</p>	<ul style="list-style-type: none"> • CMOS output • Hysteresis input • Analog input • With pull-up control
K	<p>P-ch</p> <p>N-ch</p> <p>Digital output</p> <p>Digital output</p> <p>Hysteresis input</p> <p>Standby control</p>	<ul style="list-style-type: none"> • CMOS output • Hysteresis input
L	<p>P-ch</p> <p>N-ch</p> <p>Digital output</p> <p>Digital output</p> <p>CMOS input</p> <p>Hysteresis input</p> <p>Standby control</p>	<ul style="list-style-type: none"> • CMOS output • CMOS input • Hysteresis input
O	<p>N-ch</p> <p>Digital output</p> <p>Hysteresis input</p> <p>Standby control</p>	<ul style="list-style-type: none"> • N-ch open drain output • Hysteresis input

(Continued)

(Continued)

Type	Circuit	Remarks
P	<p>The circuit diagram shows a CMOS output stage. It includes a pull-up resistor (R) connected to a supply rail. A P-channel MOSFET (P-ch) is connected to the supply rail, and an N-channel MOSFET (N-ch) is connected to ground. The gates of both MOSFETs are driven by a signal that is also connected to a 'Pull-up control' input. The output of the N-channel MOSFET is labeled 'Digital output'. A 'Hysteresis input' is connected to the gate of the N-channel MOSFET. The circuit is also controlled by 'Standby control' and 'External interrupt control' signals.</p>	<ul style="list-style-type: none"> • CMOS output • Hysteresis input • With pull-up control

MB95100B Series

■ HANDLING DEVICES

- Preventing Latch-up

Care must be taken to ensure that maximum voltage ratings are not exceeded when they are used.

Latch-up may occur on CMOS ICs if voltage higher than V_{CC} or lower than V_{SS} is applied to input and output pins other than medium- and high-withstand voltage pins or if higher than the rating voltage is applied between V_{CC} pin and V_{SS} pins.

When latch-up occurs, power supply current increases rapidly and might thermally damage elements.

Also, take care to prevent the analog power supply voltage (AV_{CC} , AVR) and analog input voltage from exceeding the digital power supply voltage (V_{CC}) when the analog system power supply is turned on or off.

- Stable Supply Voltage

Supply voltage should be stabilized.

A sudden change in power-supply voltage may cause a malfunction even within the guaranteed operating range of the V_{CC} power-supply voltage.

For stabilization, in principle, keep the variation in V_{CC} ripple (p-p value) in a commercial frequency range (50/60 Hz) not to exceed 10% of the standard V_{CC} value and suppress the voltage variation so that the transient variation rate does not exceed 0.1 V/ms during a momentary change such as when the power supply is switched.

- Precautions for Use of External Clock

Even when an external clock is used, oscillation stabilization wait time is required for power-on reset, wake-up from sub clock mode or stop mode.

■ PIN CONNECTION

- Treatment of Unused Pin

Leaving unused input pins unconnected can cause abnormal operation or latch-up, leaving to permanent damage.

Unused input pins should always be pulled up or down through resistance of at least 2 k Ω . Any unused input/output pins may be set to output mode and left open, or set to input mode and treated the same as unused input pins. If there is an unused output pin, make it open.

- Treatment of Power Supply Pins on A/D Converter

Connect to be $AV_{CC} = V_{CC}$ and $AV_{SS} = AVR = V_{SS}$ even if the A/D converter is not in use.

Noise riding on the AV_{CC} pin may cause accuracy degradation. So, connect approx. 0.1 μ F ceramic capacitor as a bypass capacitor between AV_{CC} and AV_{SS} pins in the vicinity of this device.

- Power Supply Pins

In products with multiple V_{CC} or V_{SS} pins, the pins of the same potential are internally connected in the device to avoid abnormal operations including latch-up. However, you must connect the pins to external power supply and a ground line to lower the electro-magnetic emission level, to prevent abnormal operation of strobe signals caused by the rise in the ground level, and to conform to the total output current rating.

Moreover, connect the current supply source with the V_{CC} and V_{SS} pins of this device at the low impedance.

It is also advisable to connect a ceramic bypass capacitor of approximately 0.1 μ F between V_{CC} and V_{SS} pins near this device.

- Mode Pin (MOD)

Connect the MOD pin directly to V_{CC} or V_{SS} pins.

To prevent the device unintentionally entering the test mode due to noise, lay out the printed circuit board so as to minimize the distance from the MOD pin to V_{CC} or V_{SS} pin and to provide a low-impedance connection.

- Analog Power Supply

Always set the same potential to AV_{CC} and V_{CC} pins. When $V_{CC} > AV_{CC}$, the current may flow through the AN00 to AN11 pins.

- Precautions for Use of FRAM

When the device is connected to I²C external pins (SCL0 and SDA0), the device with the same slave addresses (1010000_B to 1010111_B) as built-in FRAM cannot be used.

When built-in FRAM is used without connecting the device to I²C external pins, external pull-up resistor (1.1k Ω or more) should be connected to SCL0 and SDA0 pins.

P50 and P51 cannot be used in MB95R107B, MB95D108BS, and MB95D108BW.

MB95100B Series

PROGRAMMING FLASH MEMORY MICROCONTROLLERS USING PARALLEL PROGRAMMER

Supported Parallel Programmers and Adapters

The following table lists supported parallel programmers and adapters.

Package	Applicable adapter model	Parallel programmers
FPT-64P-M03	TEF110-108F35AP	AF9708 (Ver 02.35G or more)
FPT-64P-M09	TEF110-108F36AP	AF9709/B (Ver 02.35G or more) AF9723+AF9834 (Ver 02.08E or more)

Note : For information on applicable adapter models and parallel programmers, contact the following:
Flash Support Group, Inc. TEL: +81-53-428-8380

Sector Configuration

The individual sectors of Flash memory correspond to addresses used for CPU access and programming by the parallel programmer as follows:

Flash memory	CPU address	Programmer address*
SA1 (4K bytes)	1000 _H	71000 _H
	1FFF _H	71FFF _H
SA2 (4K bytes)	2000 _H	72000 _H
	2FFF _H	72FFF _H
SA3 (4K bytes)	3000 _H	73000 _H
	3FFF _H	73FFF _H
SA4 (16K bytes)	4000 _H	74000 _H
	7FFF _H	77FFF _H
SA5 (16K bytes)	8000 _H	78000 _H
	BFFF _H	7BFFF _H
SA6 (4K bytes)	C000 _H	7C000 _H
	CFFF _H	7CFFF _H
SA7 (4K bytes)	D000 _H	7D000 _H
	DFFF _H	7DFFF _H
SA8 (4K bytes)	E000 _H	7E000 _H
	EFFF _H	7EFFF _H
SA9 (4K bytes)	F000 _H	7F000 _H
	FFFF _H	7FFFF _H

*: Programmer addresses are corresponding to CPU addresses, used when the parallel programmer programs data into Flash memory.
These programmer addresses are used for the parallel programmer to program or erase data in Flash memory.

Programming Method

- 1) Set the type code of the parallel programmer to 17226.
- 2) Load program data to parallel programmer addresses 71000_H to 7FFFF_H.
- 3) Programmed by parallel programmer

■ BLOCK DIAGRAM

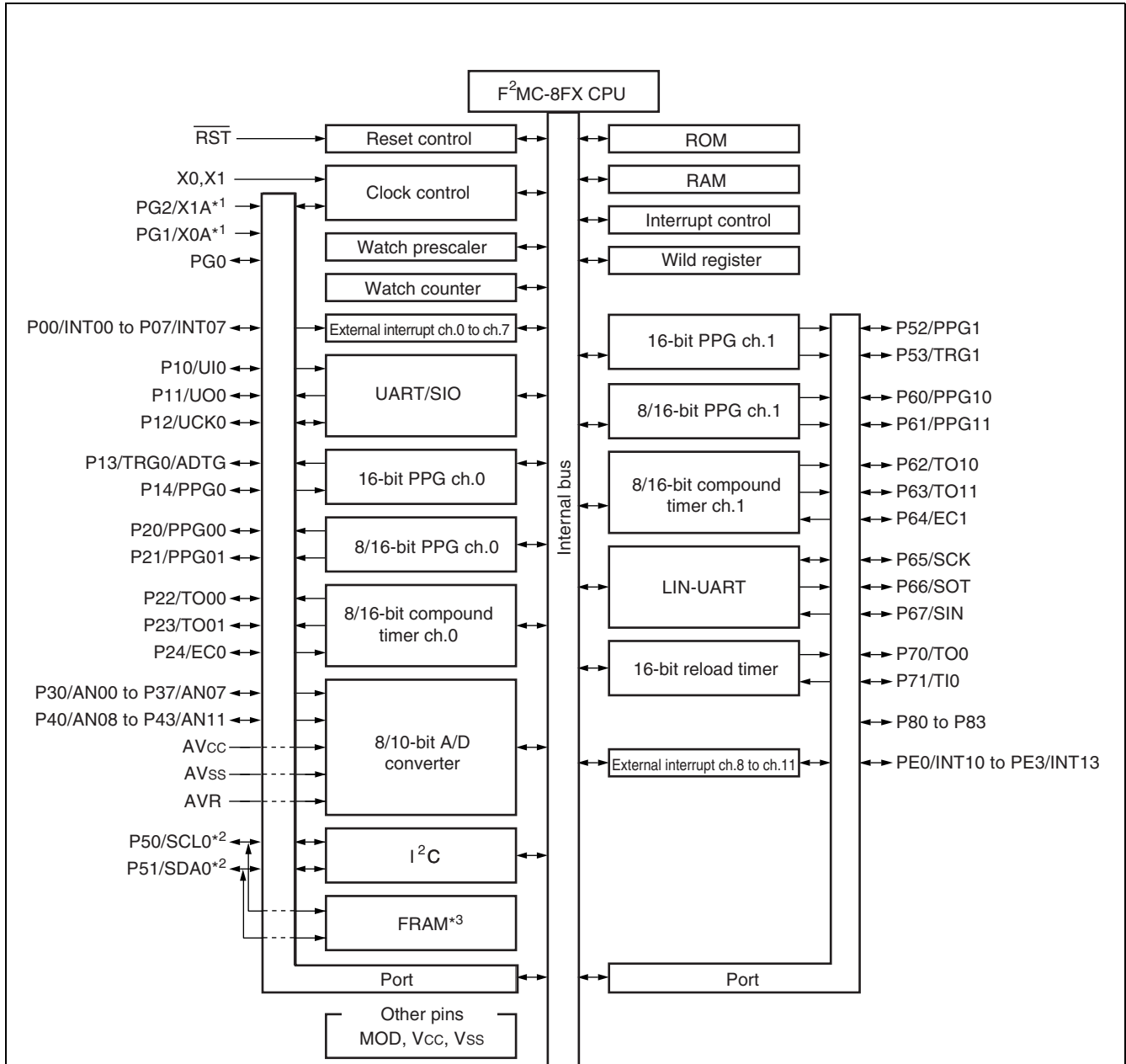

*1 : Single clock product is general-purpose port, and dual clock product is sub clock oscillation pin.

*2 : P50 and P51 cannot be used in MB95R107B, MB95D108BS, and MB95D108BW.

*3 : MB95R107B, MB95D108BS, and MB95D108BW only

MB95100B Series

■ CPU CORE

1. Memory space

Memory space of the MB95100B series is 64 Kbytes and consists of I/O area, data area, and program area. The memory space includes special-purpose areas such as the general-purpose registers and vector table. Memory map of the MB95100B series is shown below.

• Memory Map

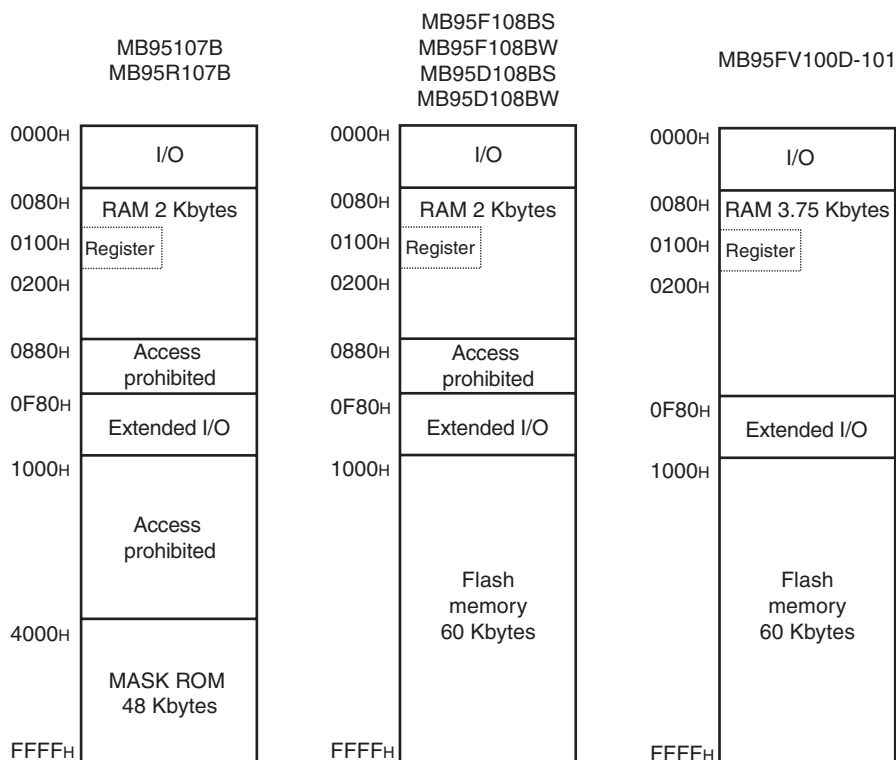

2. Register

The MB95100B series has two types of registers; dedicated registers in the CPU and general-purpose registers in the memory. The dedicated registers are as follows:

- Program counter (PC) : A 16-bit register to indicate locations where instructions are stored
- Accumulator (A) : A 16-bit register for temporary storage of arithmetic operations. In the case of an 8-bit data processing instruction, the lower 1 byte is used.
- Temporary accumulator (T) : A 16-bit register which performs arithmetic operations with the accumulator. In the case of an 8-bit data processing instruction, the lower 1 byte is used.
- Index register (IX) : A 16-bit register for index modification
- Extra pointer (EP) : A 16-bit pointer to point to a memory address
- Stack pointer (SP) : A 16-bit register to indicate a stack area
- Program status (PS) : A 16-bit register for storing a register bank pointer, a direct bank pointer, and a condition code register

16-bit		Initial Value
PC	: Program counter	FFFD _H
A	: Accumulator	0000 _H
T	: Temporary accumulator	0000 _H
IX	: Index register	0000 _H
EP	: Extra pointer	0000 _H
SP	: Stack pointer	0000 _H
PS	: Program status	0030 _H

The PS can further be divided into higher 8 bits for use as a register bank pointer (RP) and a direct bank pointer (DP) and the lower 8 bits for use as a condition code register (CCR) . (Refer to the diagram below.)

• Structure of the program status

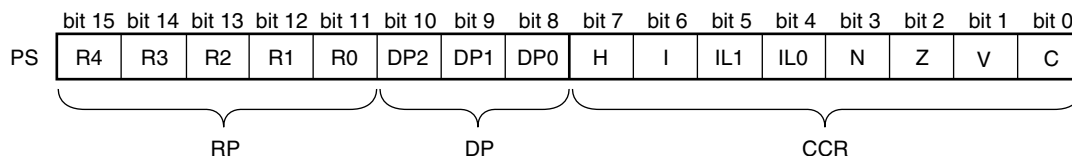

MB95100B Series

The RP indicates the address of the register bank currently being used. The relationship between the content of RP and the real address conforms to the conversion rule illustrated below:

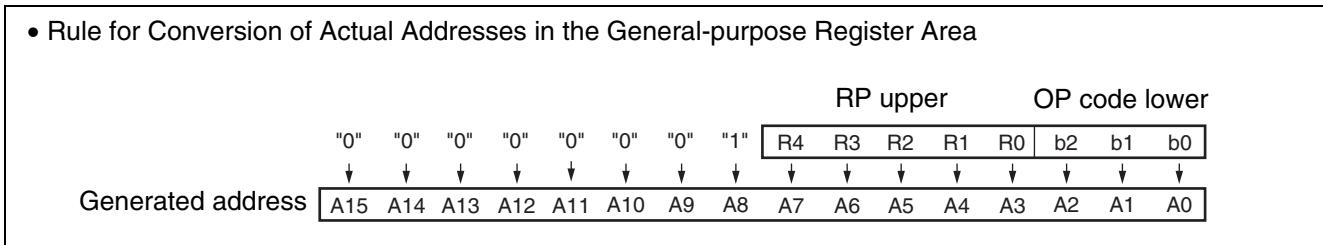

The DP specifies the area for mapping instructions (16 different instructions such as MOV A, dir) using direct addresses to 0080H to 00FFH.

Direct bank pointer (DP2 to DP0)	Specified address area	Mapping area
XXX _B (no effect to mapping)	0000 _H to 007F _H	0000 _H to 007F _H (without mapping)
000 _B (initial value)	0080 _H to 00FF _H	0080 _H to 00FF _H (without mapping)
001 _B		0100 _H to 017F _H
010 _B		0180 _H to 01FF _H
011 _B		0200 _H to 027F _H
100 _B		0280 _H to 02FF _H
101 _B		0300 _H to 037F _H
110 _B		0380 _H to 03FF _H
111 _B		0400 _H to 047F _H

The CCR consists of the bits indicating arithmetic operation results or transfer data contents and the bits that control CPU operations at interrupt.

- H flag : Set to "1" when a carry or a borrow from bit 3 to bit 4 occurs as a result of an arithmetic operation. Cleared to "0" otherwise. This flag is for decimal adjustment instructions.
- I flag : Interrupt is enabled when this flag is set to "1". Interrupt is disabled when this flag is set to "0". The flag is cleared to "0" when reset.
- IL1, IL0 : Indicates the level of the interrupt currently enabled. Processes an interrupt only if its request level is higher than the value indicated by these bits.

IL1	IL0	Interrupt level	Priority
0	0	0	High ↑↓ Low = no interruption
0	1	1	
1	0	2	
1	1	3	

- N flag : Set to "1" if the MSB is set to "1" as the result of an arithmetic operation. Cleared to "0" when the bit is set to "0".
- Z flag : Set to "1" when an arithmetic operation results in "0". Cleared to "0" otherwise.
- V flag : Set to "1" if the complement on 2 overflows as a result of an arithmetic operation. Cleared to "0" otherwise.
- C flag : Set to "1" when a carry or a borrow from bit 7 occurs as a result of an arithmetic operation. Cleared to "0" otherwise. Set to the shift-out value in the case of a shift instruction.

MB95100B Series

The following general-purpose registers are provided:

General-purpose registers: 8-bit data storage registers

The general-purpose registers are 8 bits and located in the register banks on the memory. 1-bank contains 8-register. Up to a total of 32 banks can be used on the MB95100B series. The bank currently in use is specified by the register bank pointer (RP), and the lower 3 bits of OP code indicates the general-purpose register 0 (R0) to general-purpose register 7 (R7).

- Register Bank Configuration

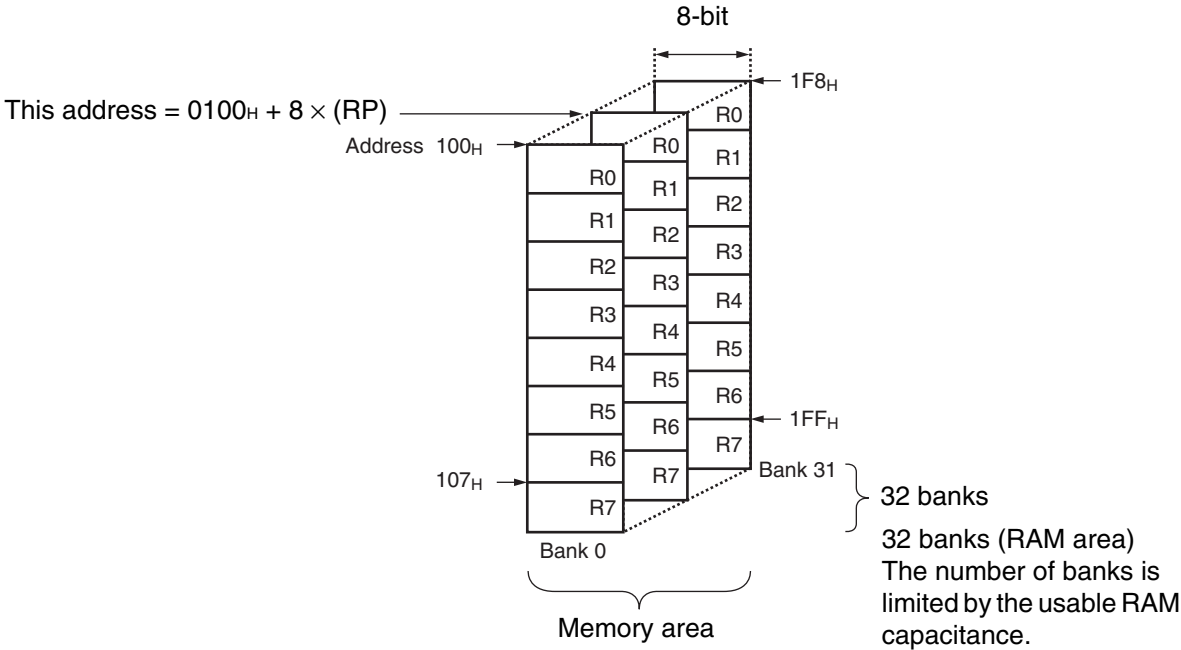

MB95100B Series

■ FRAM

• Slave address of FRAM

FRAM operates as one of the slave devices connected to the I²C, and the I²C is used to read from or write to FRAM. When data is transferred by the I²C, the slave address of FRAM is shown below.

Slave address (7 bits)				R/W bit (1 bit)
Slave ID (4 bits)		Page select bit* (3 bits)		
1	0	1	0	0 : at write 1 : at read
				000 _B : page 0 001 _B : page 1 010 _B : page 2 011 _B : page 3 100 _B : page 4 101 _B : page 5 110 _B : page 6 111 _B : page 7

* : Page select bit : Set the value corresponding to the accessed page

• Memory configuration of FRAM

The capacitance of the built-in FRAM is 2 Kbytes. The memory configuration of FRAM consists of 8 pages as follows. The capacitance of each page is 256 bytes.

Page	Address	Capacitance
0	00 _H to FF _H	256 bytes
1	00 _H to FF _H	256 bytes
2	00 _H to FF _H	256 bytes
3	00 _H to FF _H	256 bytes
4	00 _H to FF _H	256 bytes
5	00 _H to FF _H	256 bytes
6	00 _H to FF _H	256 bytes
7	00 _H to FF _H	256 bytes

• Single byte write

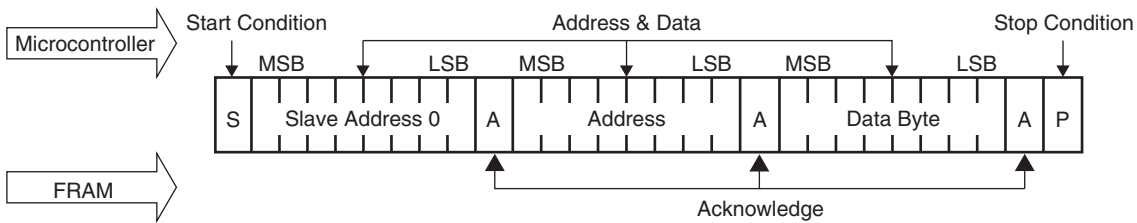

• Compound byte write

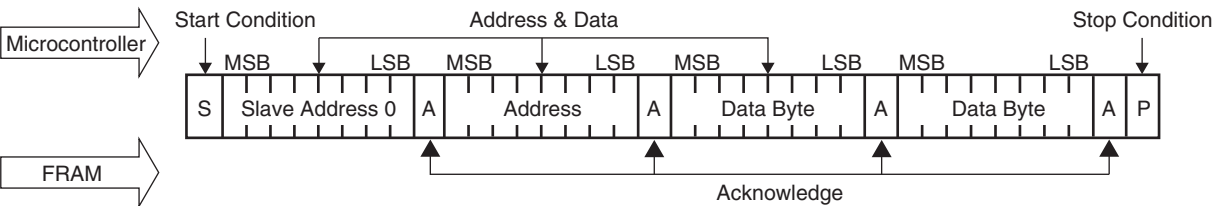

• Current address read

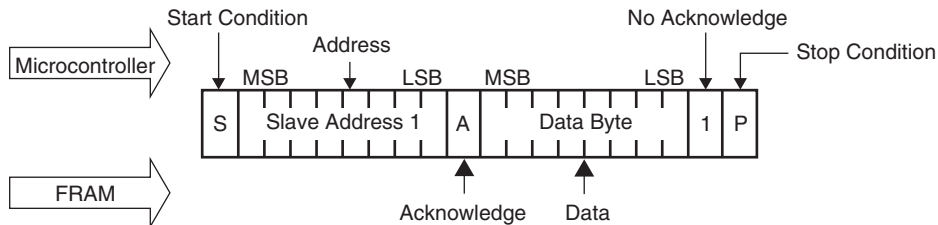

• Continuous address read

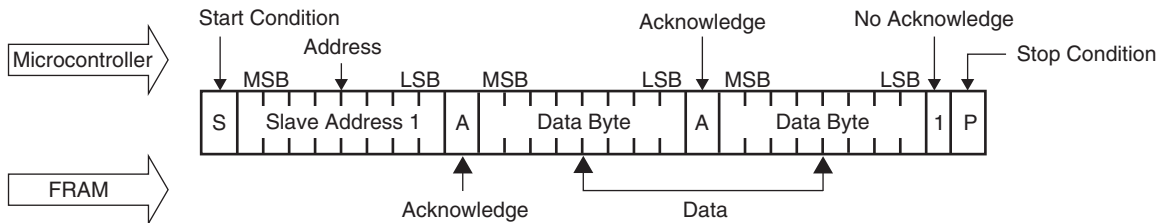

• Select (random) read

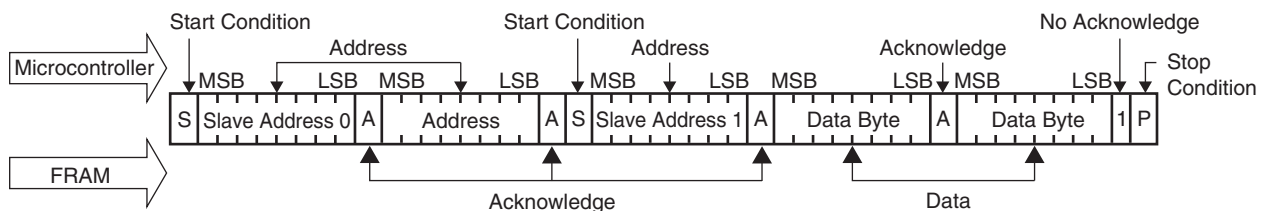

- Notes :
- When the device is connected to I²C external pins (SCL0 and SDA0), the device with the same addresses (1010000_B to 1010111_B) as built-in FRAM cannot be used.
 - When FRAM is used without connecting the device built into the pull-up resistor to I²C external pins, external pull-up resistor (1.1 kΩ or more) should be connected to SCL0 and SDA0 pins.
 - P50 and P51 cannot be used in MB95R107B, MB95D108BS, and MB95D108BW.

MB95100B Series

■ I/O MAP

Address	Register abbreviation	Register name	R/W	Initial value
0000 _H	PDR0	Port 0 data register	R/W	00000000 _B
0001 _H	DDR0	Port 0 direction register	R/W	00000000 _B
0002 _H	PDR1	Port 1 data register	R/W	00000000 _B
0003 _H	DDR1	Port 1 direction register	R/W	00000000 _B
0004 _H	—	(Disabled)	—	—
0005 _H	WATR	Oscillation stabilization wait time setting register	R/W	11111111 _B
0006 _H	PLLC	PLL control register	R/W	00000000 _B
0007 _H	SYCC	System clock control register	R/W	1010X011 _B
0008 _H	STBC	Standby control register	R/W	00000000 _B
0009 _H	RSRR	Reset source register	R	XXXXXXXX _B
000A _H	TBTC	Timebase timer control register	R/W	00000000 _B
000B _H	WPCR	Watch prescaler control register	R/W	00000000 _B
000C _H	WDTC	Watchdog timer control register	R/W	00000000 _B
000D _H	—	(Disabled)	—	—
000E _H	PDR2	Port 2 data register	R/W	00000000 _B
000F _H	DDR2	Port 2 direction register	R/W	00000000 _B
0010 _H	PDR3	Port 3 data register	R/W	00000000 _B
0011 _H	DDR3	Port 3 direction register	R/W	00000000 _B
0012 _H	PDR4	Port 4 data register	R/W	00000000 _B
0013 _H	DDR4	Port 4 direction register	R/W	00000000 _B
0014 _H	PDR5	Port 5 data register	R/W	00000000 _B
0015 _H	DDR5	Port 5 direction register	R/W	00000000 _B
0016 _H	PDR6	Port 6 data register	R/W	00000000 _B
0017 _H	DDR6	Port 6 direction register	R/W	00000000 _B
0018 _H	PDR7	Port 7 data register	R/W	00000000 _B
0019 _H	DDR7	Port 7 direction register	R/W	00000000 _B
001A _H	PDR8	Port 8 data register	R/W	00000000 _B
001B _H	DDR8	Port 8 direction register	R/W	00000000 _B
001C _H to 0025 _H	—	(Disabled)	—	—
0026 _H	PDRE	Port E data register	R/W	00000000 _B
0027 _H	DDRE	Port E direction register	R/W	00000000 _B
0028 _H , 0029 _H	—	(Disabled)	—	—
002A _H	PDRG	Port G data register	R/W	00000000 _B

(Continued)

MB95100B Series

Address	Register abbreviation	Register name	R/W	Initial value
002B _H	DDRG	Port G direction register	R/W	00000000 _B
002C _H	—	(Disabled)	—	—
002D _H	PUL1	Port 1 pull - up register	R/W	00000000 _B
002E _H	PUL2	Port 2 pull - up register	R/W	00000000 _B
002F _H	PUL3	Port 3 pull - up register	R/W	00000000 _B
0030 _H	PUL4	Port 4 pull - up register	R/W	00000000 _B
0031 _H	PUL5	Port 5 pull - up register	R/W	00000000 _B
0032 _H	PUL7	Port 7 pull - up register	R/W	00000000 _B
0033 _H	—	(Disabled)	—	—
0034 _H	PULE	Port E pull - up register	R/W	00000000 _B
0035 _H	PULG	Port G pull - up register	R/W	00000000 _B
0036 _H	T01CR1	8/16-bit compound timer 01 control status register 1 ch.0	R/W	00000000 _B
0037 _H	T00CR1	8/16-bit compound timer 00 control status register 1 ch.0	R/W	00000000 _B
0038 _H	T11CR1	8/16-bit compound timer 11 control status register 1 ch.1	R/W	00000000 _B
0039 _H	T10CR1	8/16-bit compound timer 10 control status register 1 ch.1	R/W	00000000 _B
003A _H	PC01	8/16-bit PPG1 control register ch.0	R/W	00000000 _B
003B _H	PC00	8/16-bit PPG0 control register ch.0	R/W	00000000 _B
003C _H	PC11	8/16-bit PPG1 control register ch.1	R/W	00000000 _B
003D _H	PC10	8/16-bit PPG0 control register ch.1	R/W	00000000 _B
003E _H	TMCSRH0	16-bit reload timer control status register (Upper byte) ch.0	R/W	00000000 _B
003F _H	TMCSRL0	16-bit reload timer control status register (Lower byte) ch.0	R/W	00000000 _B
0040 _H , 0041 _H	—	(Disabled)	—	—
0042 _H	PCNTH0	16-bit PPG control status register (Upper byte) ch.0	R/W	00000000 _B
0043 _H	PCNTL0	16-bit PPG control status register (Lower byte) ch.0	R/W	00000000 _B
0044 _H	PCNTH1	16-bit PPG control status register (Upper byte) ch.1	R/W	00000000 _B
0045 _H	PCNTL1	16-bit PPG control status register (Lower byte) ch.1	R/W	00000000 _B
0046 _H , 0047 _H	—	(Disabled)	—	—
0048 _H	EIC00	External interrupt circuit control register ch.0/ch.1	R/W	00000000 _B
0049 _H	EIC10	External interrupt circuit control register ch.2/ch.3	R/W	00000000 _B
004A _H	EIC20	External interrupt circuit control register ch.4/ch.5	R/W	00000000 _B
004B _H	EIC30	External interrupt circuit control register ch.6/ch.7	R/W	00000000 _B
004C _H	EIC01	External interrupt circuit control register ch.8/ch.9	R/W	00000000 _B
004D _H	EIC11	External interrupt circuit control register ch.10/ch.11	R/W	00000000 _B

(Continued)

MB95100B Series

Address	Register abbreviation	Register name	R/W	Initial value
004E _H , 004F _H	—	(Disabled)	—	—
0050 _H	SCR	LIN-UART serial control register	R/W	00000000 _B
0051 _H	SMR	LIN-UART serial mode register	R/W	00000000 _B
0052 _H	SSR	LIN-UART serial status register	R/W	00001000 _B
0053 _H	RDR/TDR	LIN-UART reception/transmission data register	R/W	00000000 _B
0054 _H	ESCR	LIN-UART extended status control register	R/W	00000100 _B
0055 _H	ECCR	LIN-UART extended communication control register	R/W	000000XX _B
0056 _H	SMC10	UART/SIO serial mode control register 1 ch.0	R/W	00000000 _B
0057 _H	SMC20	UART/SIO serial mode control register 2 ch.0	R/W	00100000 _B
0058 _H	SSR0	UART/SIO serial status register ch.0	R/W	00000001 _B
0059 _H	TDR0	UART/SIO serial output data register ch.0	R/W	00000000 _B
005A _H	RDR0	UART/SIO serial input data register ch.0	R	00000000 _B
005B _H to 005F _H	—	(Disabled)	—	—
0060 _H	IBCR00	I ² C bus control register 0 ch.0	R/W	00000000 _B
0061 _H	IBCR10	I ² C bus control register 1 ch.0	R/W	00000000 _B
0062 _H	IBSR0	I ² C bus status register ch.0	R	00000000 _B
0063 _H	IDDR0	I ² C data register ch.0	R/W	00000000 _B
0064 _H	IAAR0	I ² C address register ch.0	R/W	00000000 _B
0065 _H	ICCR0	I ² C clock control register ch.0	R/W	00000000 _B
0066 _H to 006B _H	—	(Disabled)	—	—
006C _H	ADC1	8/10-bit A/D converter control register 1	R/W	00000000 _B
006D _H	ADC2	8/10-bit A/D converter control register 2	R/W	00000000 _B
006E _H	ADDH	8/10-bit A/D converter data register (Upper byte)	R/W	00000000 _B
006F _H	ADDL	8/10-bit A/D converter data register (Lower byte)	R/W	00000000 _B
0070 _H	WCSR	Watch counter status register	R/W	00000000 _B
0071 _H	—	(Disabled)	—	—
0072 _H	FSR	Flash memory status register	R/W	000X0000 _B
0073 _H	SWRE0	Flash memory sector writing control register 0	R/W	00000000 _B
0074 _H	SWRE1	Flash memory sector writing control register 1	R/W	00000000 _B
0075 _H	—	(Disabled)	—	—
0076 _H	WREN	Wild register address compare enable register	R/W	00000000 _B
0077 _H	WROR	Wild register data test setting register	R/W	00000000 _B

(Continued)

MB95100B Series

Address	Register abbreviation	Register name	R/W	Initial value
0078 _H	—	Mirror of register bank pointer (RP) and direct bank pointer (DP)	—	—
0079 _H	ILR0	Interrupt level setting register 0	R/W	11111111 _B
007A _H	ILR1	Interrupt level setting register 1	R/W	11111111 _B
007B _H	ILR2	Interrupt level setting register 2	R/W	11111111 _B
007C _H	ILR3	Interrupt level setting register 3	R/W	11111111 _B
007D _H	ILR4	Interrupt level setting register 4	R/W	11111111 _B
007E _H	ILR5	Interrupt level setting register 5	R/W	11111111 _B
007F _H	—	(Disabled)	—	—
0F80 _H	WRARH0	Wild register address setting register (Upper byte) ch.0	R/W	00000000 _B
0F81 _H	WRARL0	Wild register address setting register (Lower byte) ch.0	R/W	00000000 _B
0F82 _H	WRDR0	Wild register data setting register ch.0	R/W	00000000 _B
0F83 _H	WRARH1	Wild register address setting register (Upper byte) ch.1	R/W	00000000 _B
0F84 _H	WRARL1	Wild register address setting register (Lower byte) ch.1	R/W	00000000 _B
0F85 _H	WRDR1	Wild register data setting register ch.1	R/W	00000000 _B
0F86 _H	WRARH2	Wild register address setting register (Upper byte) ch.2	R/W	00000000 _B
0F87 _H	WRARL2	Wild register address setting register (Lower byte) ch.2	R/W	00000000 _B
0F88 _H	WRDR2	Wild register data setting register ch.2	R/W	00000000 _B
0F89 _H to 0F91 _H	—	(Disabled)	—	—
0F92 _H	T01CR0	8/16-bit compound timer 01 control status register 0 ch.0	R/W	00000000 _B
0F93 _H	T00CR0	8/16-bit compound timer 00 control status register 0 ch.0	R/W	00000000 _B
0F94 _H	T01DR	8/16-bit compound timer 01 data register ch.0	R/W	00000000 _B
0F95 _H	T00DR	8/16-bit compound timer 00 data register ch.0	R/W	00000000 _B
0F96 _H	TMCR0	8/16-bit compound timer 00/01 timer mode control register ch.0	R/W	00000000 _B
0F97 _H	T11CR0	8/16-bit compound timer 11 control status register 0 ch.1	R/W	00000000 _B
0F98 _H	T10CR0	8/16-bit compound timer 10 control status register 0 ch.1	R/W	00000000 _B
0F99 _H	T11DR	8/16-bit compound timer 11 data register ch.1	R/W	00000000 _B
0F9A _H	T10DR	8/16-bit compound timer 10 data register ch.1	R/W	00000000 _B
0F9B _H	TMCR1	8/16-bit compound timer 10/11 timer mode control register ch.1	R/W	00000000 _B
0F9C _H	PPS01	8/16-bit PPG1 cycle setting buffer register ch.0	R/W	11111111 _B
0F9D _H	PPS00	8/16-bit PPG0 cycle setting buffer register ch.0	R/W	11111111 _B
0F9E _H	PDS01	8/16-bit PPG1 duty setting buffer register ch.0	R/W	11111111 _B
0F9F _H	PDS00	8/16-bit PPG0 duty setting buffer register ch.0	R/W	11111111 _B

(Continued)

MB95100B Series

Address	Register abbreviation	Register name	R/W	Initial value
0FA0 _H	PPS11	8/16-bit PPG1 cycle setting buffer register ch.1	R/W	11111111 _B
0FA1 _H	PPS10	8/16-bit PPG0 cycle setting buffer register ch.1	R/W	11111111 _B
0FA2 _H	PDS11	8/16-bit PPG1 duty setting buffer register ch.1	R/W	11111111 _B
0FA3 _H	PDS10	8/16-bit PPG0 duty setting buffer register ch.1	R/W	11111111 _B
0FA4 _H	PPGS	8/16-bit PPG start register	R/W	00000000 _B
0FA5 _H	REVC	8/16-bit PPG output inversion register	R/W	00000000 _B
0FA6 _H	TMRH0/ TMRLRH0	16-bit timer register (Upper byte) ch.0/ 16-bit reload register (Upper byte) ch.0	R/W	00000000 _B
0FA7 _H	TMRL0/ TMRLRL0	16-bit timer register (Lower byte) ch.0/ 16-bit reload register (Lower byte) ch.0	R/W	00000000 _B
0FA8 _H , 0FA9 _H	—	(Disabled)	—	—
0FAA _H	PDCRH0	16-bit PPG down counter register (Upper byte) ch.0	R	00000000 _B
0FAB _H	PDCRL0	16-bit PPG down counter register (Lower byte) ch.0	R	00000000 _B
0FAC _H	PCSRH0	16-bit PPG cycle setting buffer register (Upper byte) ch.0	R/W	11111111 _B
0FAD _H	PCSRL0	16-bit PPG cycle setting buffer register (Lower byte) ch.0	R/W	11111111 _B
0FAE _H	PDUTH0	16-bit PPG duty setting buffer register (Upper byte) ch.0	R/W	11111111 _B
0FAF _H	PDUTL0	16-bit PPG duty setting buffer register (Lower byte) ch.0	R/W	11111111 _B
0FB0 _H	PDCRH1	16-bit PPG down counter register (Upper byte) ch.1	R	00000000 _B
0FB1 _H	PDCRL1	16-bit PPG down counter register (Lower byte) ch.1	R	00000000 _B
0FB2 _H	PCSRH1	16-bit PPG cycle setting buffer register (Upper byte) ch.1	R/W	11111111 _B
0FB3 _H	PCSRL1	16-bit PPG cycle setting buffer register (Lower byte) ch.1	R/W	11111111 _B
0FB4 _H	PDUTH1	16-bit PPG duty setting buffer register (Upper byte) ch.1	R/W	11111111 _B
0FB5 _H	PDUTL1	16-bit PPG duty setting buffer register (Lower byte) ch.1	R/W	11111111 _B
0FB6 _H to 0FBB _H	—	(Disabled)	—	—
0FBC _H	BGR1	LIN-UART baud rate generator register 1	R/W	00000000 _B
0FBD _H	BGR0	LIN-UART baud rate generator register 0	R/W	00000000 _B
0FBE _H	PSSR0	UART/SIO dedicated baud rate generator prescaler select register ch.0	R/W	00000000 _B
0FBF _H	BRSR0	UART/SIO dedicated baud rate generator baud rate setting register ch.0	R/W	00000000 _B
0FC0 _H , 0FC1 _H	—	(Disabled)	—	—
0FC2 _H	AIDRH	A/D input disable register (Upper byte)	R/W	00000000 _B
0FC3 _H	AIDRL	A/D input disable register (Lower byte)	R/W	00000000 _B

(Continued)

(Continued)

Address	Register abbreviation	Register name	R/W	Initial value
0FC4 _H to 0FE2 _H	—	(Disabled)	—	—
0FE3 _H	WCDR	Watch counter data register	R/W	00111111 _B
0FE4 _H to 0FED _H	—	(Disabled)	—	—
0FEE _H	ILSR	Input level select register	R/W	00000000 _B
0FEF _H	WICR	Interrupt pin control register	R/W	01000000 _B
0FF0 _H to 0FFF _H	—	(Disabled)	—	—

- R/W access symbols

R/W : Readable/Writable

R : Read only

W : Write only

- Initial value symbols

0 : The initial value of this bit is "0".

1 : The initial value of this bit is "1".

X : The initial value of this bit is undefined.

Note : Do not write to the "(Disabled)". Reading the "(Disabled)" returns an undefined value.

MB95100B Series

■ INTERRUPT SOURCE TABLE

Interrupt source	Interrupt request number	Vector table address		Bit name of interrupt level setting register	Same level priority order (at simultaneous occurrence)
		Upper	Lower		
External interrupt ch.0	IRQ0	FFFA _H	FFFB _H	L00 [1 : 0]	<div style="display: flex; align-items: center; justify-content: center;"> <div style="margin-right: 10px;">High</div> <div style="margin-left: 10px;">Low</div> </div>
External interrupt ch.4					
External interrupt ch.1	IRQ1	FFF8 _H	FFF9 _H	L01 [1 : 0]	
External interrupt ch.5					
External interrupt ch.2	IRQ2	FFF6 _H	FFF7 _H	L02 [1 : 0]	
External interrupt ch.6					
External interrupt ch.3	IRQ3	FFF4 _H	FFF5 _H	L03 [1 : 0]	
External interrupt ch.7					
UART/SIO ch.0	IRQ4	FFF2 _H	FFF3 _H	L04 [1 : 0]	
8/16-bit compound timer ch.0 (Lower)	IRQ5	FFF0 _H	FFF1 _H	L05 [1 : 0]	
8/16-bit compound timer ch.0 (Upper)	IRQ6	FFEE _H	FFEF _H	L06 [1 : 0]	
LIN-UART (reception)	IRQ7	FFEC _H	FFED _H	L07 [1 : 0]	
LIN-UART (transmission)	IRQ8	FFEA _H	FFEB _H	L08 [1 : 0]	
8/16-bit PPG ch.1 (Lower)	IRQ9	FFE8 _H	FFE9 _H	L09 [1 : 0]	
8/16-bit PPG ch.1 (Upper)	IRQ10	FFE6 _H	FFE7 _H	L10 [1 : 0]	
16-bit reload timer ch.0	IRQ11	FFE4 _H	FFE5 _H	L11 [1 : 0]	
8/16-bit PPG ch.0 (Upper)	IRQ12	FFE2 _H	FFE3 _H	L12 [1 : 0]	
8/16-bit PPG ch.0 (Lower)	IRQ13	FFE0 _H	FFE1 _H	L13 [1 : 0]	
8/16-bit compound timer ch.1 (Upper)	IRQ14	FFDE _H	FFDF _H	L14 [1 : 0]	
16-bit PPG ch.0	IRQ15	FFDC _H	FFDD _H	L15 [1 : 0]	
I ² C ch.0	IRQ16	FFDA _H	FFDB _H	L16 [1 : 0]	
16-bit PPG ch.1	IRQ17	FFD8 _H	FFD9 _H	L17 [1 : 0]	
8/10-bit A/D converter	IRQ18	FFD6 _H	FFD7 _H	L18 [1 : 0]	
Timebase timer	IRQ19	FFD4 _H	FFD5 _H	L19 [1 : 0]	
Watch timer/Watch counter	IRQ20	FFD2 _H	FFD3 _H	L20 [1 : 0]	
External interrupt ch.8	IRQ21	FFD0 _H	FFD1 _H	L21 [1 : 0]	
External interrupt ch.9					
External interrupt ch.10					
External interrupt ch.11					
8/16-bit compound timer ch.1 (Lower)	IRQ22	FFCE _H	FFCF _H	L22 [1 : 0]	
Flash memory	IRQ23	FFCC _H	FFCD _H	L23 [1 : 0]	

■ ELECTRICAL CHARACTERISTICS

1. Absolute Maximum Ratings

Parameter	Symbol	Rating		Unit	Remarks
		Min	Max		
Power supply voltage*1	V _{CC} AV _{CC}	V _{SS} - 0.3	V _{SS} + 4.0	V	*2
	AVR	V _{SS} - 0.3	V _{SS} + 4.0		*2
Input voltage*1	V _{I1}	V _{SS} - 0.3	V _{SS} + 4.0	V	Other than P80 to P83*3
	V _{I2}	V _{SS} - 0.3	V _{SS} + 6.0		P80 to P83
Output voltage*1	V _O	V _{SS} - 0.3	V _{SS} + 4.0	V	*3
Maximum clamp current	I _{CLAMP}	- 2.0	+ 2.0	mA	Applicable to pins*4
Total maximum clamp current	Σ I _{CLAMP}	—	20	mA	Applicable to pins*4
“L” level maximum output current	I _{OL1}	—	15	mA	Other than P00 to P07
	I _{OL2}		15		P00 to P07
“L” level average current	I _{OLAV1}	—	4	mA	Other than P00 to P07 Average output current = operating current × operating ratio (1 pin)
	I _{OLAV2}		12		P00 to P07 Average output current = operating current × operating ratio (1 pin)
“L” level total maximum output current	ΣI _{OL}	—	100	mA	
“L” level total average output current	ΣI _{OLAV}	—	50	mA	Total average output current = operating current × operating ratio (Total of pins)
“H” level maximum output current	I _{OH1}	—	- 15	mA	Other than P00 to P07
	I _{OH2}		- 15		P00 to P07
“H” level average current	I _{OHAV1}	—	- 4	mA	Other than P00 to P07 Average output current = operating current × operating ratio (1 pin)
	I _{OHAV2}		- 8		P00 to P07 Average output current = operating current × operating ratio (1 pin)
“H” level total maximum output current	ΣI _{OH}	—	- 100	mA	
“H” level total average output current	ΣI _{OHAV}	—	- 50	mA	Total average output current = operating current × operating ratio (Total of pins)

(Continued)

MB95100B Series

(Continued)

Parameter	Symbol	Rating		Unit	Remarks
		Min	Max		
Power consumption	Pd	—	320	mW	
Operating temperature	T _A	- 40	+ 85	°C	
Storage temperature	T _{STG}	- 55	+ 150	°C	MB95107B, MB95F108BS, MB95F108BW
		- 40	+ 125		MB95R107B, MB95D108BS, MB95D108BW

*1 : The parameter is based on AV_{SS} = V_{SS} = 0.0 V.

*2 : Apply equal potential to AV_{CC} and V_{CC}. AVR should not exceed AV_{CC} + 0.3 V.

*3 : V_{I1} and V_O should not exceed V_{CC} + 0.3 V. V_{I1} must not exceed the rating voltage. However, if the maximum current to/from an input is limited by some means with external components, the I_{CLAMP} rating supersedes the V_{I1} rating.

*4 : Applicable to pins : P00 to P07, P10 to P14, P20 to P24, P30 to P37, P40 to P43, P52, P53, P70, P71, PE0 to PE3, PG0

- Use within recommended operating conditions.
- Use at DC voltage (current).
- The + B signal is an input signal that exceeds V_{CC} voltage. The + B signal should always be applied a limiting resistance placed between the + B signal and the microcontroller.
- The value of the limiting resistance should be set so that when the + B signal is applied the input current to the microcontroller pin does not exceed rated values, either instantaneously or for prolonged periods.
- Note that when the microcontroller drive current is low, such as in the power saving modes, the +B input potential may pass through the protective diode and increase the potential at the V_{CC} pin, and this affects other devices.
- Note that if the + B signal is inputted when the microcontroller power supply is off (not fixed at 0 V), the power supply is provided from the pins, so that incomplete operation may result.
- Note that if the + B input is applied during power-on, the power supply is provided from the pins and the resulting power supply voltage may not be sufficient to operate the power-on reset.
- Care must be taken not to leave the + B input pin open.
- Sample recommended circuits :

• Input/Output Equivalent circuits

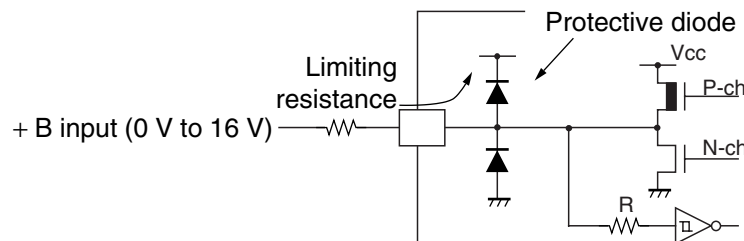

WARNING: Semiconductor devices can be permanently damaged by application of stress (voltage, current, temperature, etc.) in excess of absolute maximum ratings. Do not exceed these ratings.

MB95100B Series

2. Recommended Operating Conditions

($V_{SS} = V_{SS} = 0.0\text{ V}$)

Parameter	Symbol	Pin name	Condition	Value		Unit	Remarks
				Min	Max		
Power supply voltage	V_{CC}, AV_{CC}	—	—	1.8*	3.3	V	At normal operating, Flash memory product, $T_A = -10\text{ °C}$ to $+85\text{ °C}$
		—	—	1.8*	3.6		At normal operating, MASK ROM product, $T_A = -10\text{ °C}$ to $+85\text{ °C}$
		—	—	2.0*	3.3		At normal operating, Flash memory product, $T_A = -40\text{ °C}$ to $+85\text{ °C}$
		—	—	2.0*	3.6		At normal operating, MASK ROM product, $T_A = -40\text{ °C}$ to $+85\text{ °C}$
		—	—	2.7	3.3		At normal operating, Flash memory product, At FRAM access, $T_A = -40\text{ °C}$ to $+85\text{ °C}$
		—	—	2.7	3.6		At normal operating, MASK ROM product, At FRAM access, $T_A = -40\text{ °C}$ to $+85\text{ °C}$
		—	—	2.6	3.6		MB95FV100D-101 $T_A = +5\text{ °C}$ to $+35\text{ °C}$
		—	—	1.5	3.3		Retain status in stop mode, Flash memory product
		—	—	1.5	3.6		Retain status in stop mode, MASK ROM product
A/D converter reference input voltage	AVR	—	—	1.8	AV_{CC}	V	
Operating temperature	T_A	—	—	- 40	+ 85	°C	

* : The values vary with the operating frequency.

WARNING: The recommended operating conditions are required in order to ensure the normal operation of the semiconductor device. All of the device's electrical characteristics are warranted when the device is operated within these ranges.

Always use semiconductor devices within their recommended operating condition ranges. Operation outside these ranges may adversely affect reliability and could result in device failure.

No warranty is made with respect to uses, operating conditions, or combinations not represented on the data sheet. Users considering application outside the listed conditions are advised to contact their FUJITSU representatives beforehand.

MB95100B Series

3. DC Characteristics

($V_{CC} = AV_{CC} = 3.3\text{ V}$, $AV_{SS} = V_{SS} = 0.0\text{ V}$, $T_A = -40\text{ }^\circ\text{C}$ to $+85\text{ }^\circ\text{C}$)

Parameter	Symbol	Pin name	Conditions	Value			Unit	Remarks
				Min	Typ	Max		
"H" level input voltage	V_{IH1}	P10, P67	*1	$0.7 V_{CC}$	—	$V_{CC} + 0.3$	V	At selecting CMOS input level
	V_{IH2}	P50, P51	—	$0.7 V_{CC}$	—	$V_{SS} + 5.5$	V	At selecting CMOS input level MB95F108BS, MB95F108BW, MB95107B, MB95FV100D-101
					—	$V_{CC} + 0.3$		At selecting CMOS input level MB95D108BS, MB95D108BW, MB95R107B
	V_{IHS1}	P00 to P07, P10 to P14, P20 to P24, P30 to P37, P40 to P43, P52, P53, P60 to P67, P70, P71, PE0 to PE3, PG0, PG1*2, PG2*2	*1	$0.8 V_{CC}$	—	$V_{CC} + 0.3$	V	Hysteresis input
	V_{IHS2}	P80 to P83	*1	$0.8 V_{CC}$	—	$V_{SS} + 5.5$	V	Hysteresis input
	V_{IHS3}	P50, P51	—	$0.8 V_{CC}$	—	$V_{SS} + 5.5$	V	Hysteresis input MB95F108BS, MB95F108BW, MB95107B, MB95FV100D-101
					—	$V_{SS} + 5.0$		Hysteresis input MB95D108BS, MB95D108BW, MB95R107B
	V_{IHM}	$\overline{\text{RST}}$, MOD	—	$0.7 V_{CC}$	—	$V_{CC} + 0.3$	V	CMOS input (Flash memory product)
			—	$0.8 V_{CC}$	—	$V_{CC} + 0.3$	V	Hysteresis input (MASK ROM product)

(Continued)

MB95100B Series

($V_{CC} = AV_{CC} = 3.3\text{ V}$, $AV_{SS} = V_{SS} = 0.0\text{ V}$, $T_A = -40\text{ }^\circ\text{C}$ to $+85\text{ }^\circ\text{C}$)

Parameter	Symbol	Pin name	Conditions	Value			Unit	Remarks
				Min	Typ	Max		
“L” level input voltage	V_{IL}	P10, P50, P51, P67	*1	$V_{SS} - 0.3$	—	$0.3 V_{CC}$	V	At selecting CMOS input level (Hysteresis input)
	V_{ILS}	P00 to P07, P10 to P14, P20 to P24, P30 to P37, P40 to P43, P50 to P53, P60 to P67, P70, P71, P80 to P83, PE0 to PE3, PG0, PG1*2, PG2*2	*1	$V_{SS} - 0.3$	—	$0.2 V_{CC}$	V	Hysteresis input
	V_{ILM}	\overline{RST} , MOD	—	$V_{SS} - 0.3$	—	$0.3 V_{CC}$	V	CMOS input (Flash memory product)
			—	$V_{SS} - 0.3$	—	$0.2 V_{CC}$	V	Hysteresis input (MASK ROM product)
Input leakage current (Hi-Z output leakage current)	I_{LI}	Port other than P50, P51, P80 to P83	$0.0\text{ V} < V_I < V_{CC}$	-5	—	+5	μA	When the pull-up is prohibition setting
“H” level output voltage	V_{OH1}	Output pin other than P00 to P07	$I_{OH} = -4.0\text{ mA}$	2.4	—	—	V	
	V_{OH2}	P00 to P07	$I_{OH} = -8.0\text{ mA}$	2.4	—	—	V	
“L” level output voltage	V_{OL1}	Output pin other than P00 to P07	$I_{OL} = 4.0\text{ mA}$	—	—	0.4	V	
	V_{OL2}	P00 to P07	$I_{OL} = 12\text{ mA}$	—	—	0.4	V	
Open-drain output application voltage	V_{D1}	P80 to P83	—	$V_{SS} - 0.3$	—	$V_{SS} + 5.5$	V	
	V_{D2}	P50, P51	—	$V_{SS} - 0.3$	—	$V_{SS} + 5.5$		MB95F108BS, MB95F108BW, MB95107B
						$V_{CC} + 0.3$		MB95D108BS, MB95D108BW, MB95R107B
Open-drain output leakage current	I_{LIOD}	P50, P51, P80 to P83	$0.0\text{ V} < V_I < V_{SS} + 5.5\text{ V}$	—	—	5	μA	

(Continued)

MB95100B Series

($V_{CC} = AV_{CC} = 3.3\text{ V}$, $AV_{SS} = V_{SS} = 0.0\text{ V}$, $T_A = -40\text{ }^{\circ}\text{C}$ to $+85\text{ }^{\circ}\text{C}$)

Parameter	Symbol	Pin name	Conditions	Value			Unit	Remarks
				Min	Typ	Max		
Pull-up resistor	R_{PULL}	P10 to P14, P20 to P24, P30 to P37, P40 to P43, P52, P53, P70, P71, PE0 to PE3, PG0, PG1*2, PG2*2	$V_I = 0.0\text{ V}$	25	50	100	k Ω	When the pull-up is permission setting
Pull-down resistor	R_{MOD}	MOD	$V_I = V_{CC}$	25	50	100	k Ω	MASK ROM product
Input capacitance	C_{IN}	Other than AV_{CC} , AV_{SS} , AVR, V_{CC} , V_{SS}	$f = 1\text{ MHz}$	—	5	15	pF	
Power supply current*3	I_{CC}	V_{CC} (External clock operation)	$F_{CH} = 20\text{ MHz}$ $F_{MP} = 10\text{ MHz}$ Main clock mode (divided by 2)	—	11.0	14.0	mA	MB95F108BS, MB95F108BW (at other than Flash memory writing and erasing)
				—	30.0	35.0	mA	MB95F108BS, MB95F108BW (at Flash memory writing and erasing)
				—	7.3	10.0	mA	MB95107B
			$F_{CH} = 32\text{ MHz}$ $F_{MP} = 16\text{ MHz}$ Main clock mode (divided by 2)	—	17.6	22.4	mA	MB95F108BS, MB95F108BW (at other than Flash memory writing and erasing)
				—	38.1	44.9	mA	MB95F108BS, MB95F108BW (at Flash memory writing and erasing)
				—	11.7	16.0	mA	MB95107B
			$F_{CH} = 20\text{ MHz}$ $F_{MP} = 10\text{ MHz}$ Main clock mode (divided by 2) When FRAM read and write ($f_{SCL} = 400\text{ kHz}$)	—	11.1	15.0	mA	MB95D108BS, MB95D108BW (at other than Flash memory writing and erasing)
				—	30	35	mA	MB95D108BS, MB95D108BW (at Flash memory write and erase)
				—	7.4	11.0	mA	MB95R107B

(Continued)

MB95100B Series

($V_{CC} = AV_{CC} = 3.3\text{ V}$, $AV_{SS} = V_{SS} = 0.0\text{ V}$, $T_A = -40\text{ }^{\circ}\text{C}$ to $+85\text{ }^{\circ}\text{C}$)

Parameter	Symbol	Pin name	Conditions	Value			Unit	Remarks
				Min	Typ	Max		
Power supply current*3	I _{CC}	V _{CC} (External clock operation)	F _{CH} = 32 MHz F _{MP} = 16 MHz Main clock mode (divided by 2) When FRAM read and write (f _{SCL} = 400 kHz)	—	17.7	22.5	mA	MB95D108BS, MB95D108BW (at other than Flash memory writing and erasing)
			—	38.1	44.9	mA	MB95D108BS, MB95D108BW (at Flash memory write and erase)	
			—	11.8	16.1	mA	MB95R107B	
	I _{CCS}		F _{CH} = 20 MHz F _{MP} = 10 MHz Main Sleep mode (divided by 2)	—	4.5	6.0	mA	
			F _{CH} = 32 MHz F _{MP} = 16 MHz Main Sleep mode (divided by 2)	—	7.2	9.6	mA	
	I _{CCL}		F _{CL} = 32 kHz F _{MPL} = 16 kHz Sub clock mode (divided by 2) , T _A = +25 °C	—	25	35	μA	
	I _{CCLS}		F _{CL} = 32 kHz F _{MPL} = 16 kHz Sub sleep mode (divided by 2) , T _A = +25 °C	—	7	15	μA	
	I _{CCCT}		F _{CL} = 32 kHz Watch mode	—	2	10	μA	Flash memory product
			Main stop mode T _A = +25 °C	—	1	5	μA	MASK ROM product
	I _{CCMPLL}		F _{CH} = 4 MHz F _{MP} = 10 MHz Main PLL mode (multiplied by 2.5)	—	10	14	mA	Flash memory product
			—	6.7	10.0	mA	MASK ROM product	
			F _{CH} = 6.4 MHz F _{MP} = 16 MHz Main PLL mode (multiplied by 2.5)	—	16.0	22.4	mA	Flash memory product
—		10.8	16.0	mA	MASK ROM product			

(Continued)

MB95100B Series

(Continued)

($V_{CC} = AV_{CC} = 3.3\text{ V}$, $AV_{SS} = V_{SS} = 0.0\text{ V}$, $T_A = -40\text{ }^\circ\text{C}$ to $+85\text{ }^\circ\text{C}$)

Parameter	Symbol	Pin name	Conditions	Value			Unit	Remarks
				Min	Typ	Max		
Power supply current*3	I _{CCSPLL}	V _{CC} (External clock operation)	F _{CL} = 32 kHz F _{MPL} = 128 kHz Sub PLL mode (multiplied by 4), T _A = +25 °C	—	190	250	μA	
	I _{CTS}		F _{CH} = 10 MHz Timebase timer mode T _A = +25 °C	—	0.4	0.5	mA	
	I _{CCH}		Sub stop mode T _A = +25 °C	—	1	5	μA	
	I _A	AV _{CC}	F _{CH} = 10 MHz At operating of A/D conversion	—	1.3	2.2	mA	
	I _{AH}		F _{CH} = 10 MHz At stopping of A/D conversion T _A = +25 °C	—	1	5	μA	

*1 : P10, P50, P51, and P67 can switch the input level to either the “CMOS input level” or “hysteresis input level”. The switching of the input level can be set by the input level selection register (ILSR).

*2 : Single clock product only

*3 : Power supply current is regulated by external clock.

- Refer to “4. AC characteristics (1) Clock Timing” for F_{CH} and F_{CL}.
- Refer to “4. AC characteristics (2) Source Clock/Machine Clock” for F_{MP} and F_{MPL}.

4. AC Characteristics

(1) Clock Timing

($V_{CC} = 3.3\text{ V}$, $AV_{SS} = V_{SS} = 0.0\text{ V}$, $T_A = -40\text{ }^\circ\text{C}$ to $+85\text{ }^\circ\text{C}$)

Parameter	Symbol	Pin name	Conditions	Value			Unit	Remarks
				Min	Typ	Max		
Clock frequency	F _{CH}	X0, X1	—	1.00	—	16.25	MHz	When using main oscillation circuit
				1.00	—	32.50	MHz	When using external clock
				3.00	—	10.00	MHz	Main PLL multiplied by 1
				3.00	—	8.13	MHz	Main PLL multiplied by 2
				3.00	—	6.50	MHz	Main PLL multiplied by 2.5
				3.00	—	4.06	MHz	Main PLL multiplied by 4
	F _{CL}	X0A, X1A	—	—	32.768	—	kHz	When using sub oscillation circuit
				—	32.768	—	kHz	When using sub PLL Flash memory product : $V_{CC} = 2.3\text{ V}$ to 3.3 V MASK ROM product : $V_{CC} = 2.3\text{ V}$ to 3.6 V
Clock cycle time	t _{H CYL}	X0, X1	—	61.5	—	1000	ns	When using main oscillation circuit
				30.8	—	1000	ns	When using external clock
	t _{L CYL}	X0A, X1A		—	30.5	—	μs	When using sub oscillation circuit, When using external clock
Input clock pulse width	t _{WH1} t _{WL1}	X0	—	61.5	—	—	ns	When using external clock, duty ratio is about 30% to 70%.
	t _{WH2} t _{WL2}	X0A		—	15.2	—	μs	
Input clock rise time and fall time	t _{CR} t _{CF}	X0, X0A	—	—	10	ns	When using external clock	

MB95100B Series

- Input wave form for using external clock (main clock)

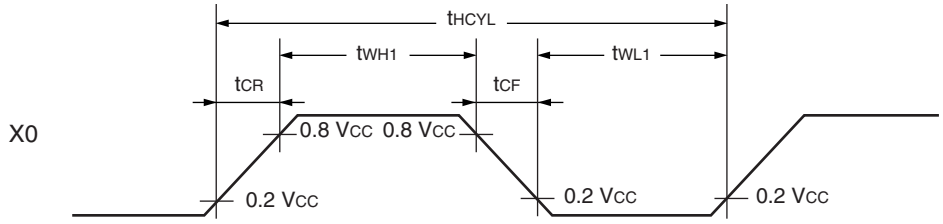

- Figure of main clock Input port external connection

When using a crystal or ceramic oscillator

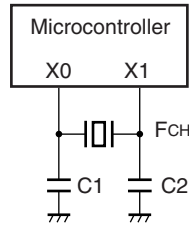

When using external clock

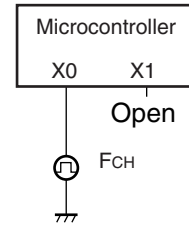

- Input wave form for using external clock (sub clock)

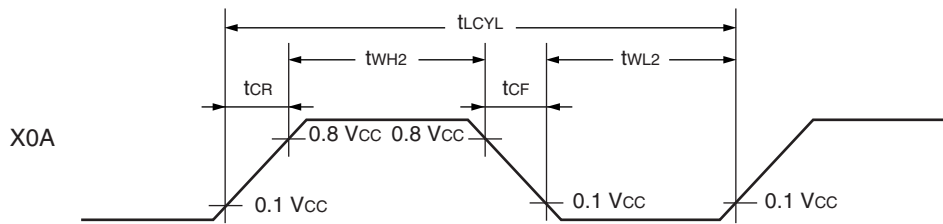

- Figure of sub clock input port external connection

When using a crystal or ceramic oscillator

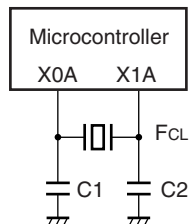

When using external clock

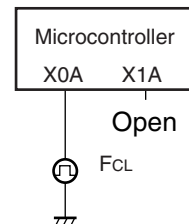

(2) Source Clock/Machine Clock

($V_{CC} = 3.3\text{ V}$, $AV_{SS} = V_{SS} = 0.0\text{ V}$, $T_A = -40\text{ }^{\circ}\text{C}$ to $+85\text{ }^{\circ}\text{C}$)

Parameter	Sym- bol	Pin name	Value			Unit	Remarks
			Min	Typ	Max		
Source clock cycle time*1 (Clock before setting division)	t _{SCLK}	—	61.5	—	2000	ns	When using main clock Min : F _{CH} = 8.125 MHz, PLL multiplied by 2 Max : F _{CH} = 1 MHz, divided by 2
			7.6	—	61.0	μs	When using sub clock Min : F _{CL} = 32 kHz, PLL multiplied by 4 Max : F _{CL} = 32 kHz, divided by 2
Source clock frequency	F _{SP}	—	0.5	—	16.25	MHz	When using main clock
	F _{SPL}	—	16.384	—	131.072	kHz	When using sub clock
Machine clock cycle time*2 (Minimum instruction execution time)	t _{MCLK}	—	100	—	32000	ns	When using main clock Min : F _{SP} = 16.25 MHz, no division Max : F _{SP} = 0.5 MHz, divided by 16
			7.6	—	976.5	μs	When using sub clock Min : F _{SPL} = 131 kHz, no division Max : F _{SPL} = 16 kHz, divided by 16
Machine clock frequency	F _{MP}	—	0.031	—	16.250	MHz	When using main clock
	F _{MPL}	—	1.024	—	131.072	kHz	When using sub clock

*1 : Clock before setting division due to machine clock division ratio selection bit (SYCC : DIV1 and DIV0) . This source clock is divided by the machine clock division ratio selection bit (SYCC : DIV1 and DIV0) , and it becomes the machine clock. Further, the source clock can be selected as follow.

- Main clock divided by 2
- PLL multiplication of main clock (select from 1, 2, 2.5, 4 multiplication)
- Sub clock divided by 2
- PLL multiplication of sub clock (select from 2, 3, 4 multiplication)

*2 : Operation clock of the microcontroller. Machine clock can be selected as follow.

- Source clock (no division)
- Source clock divided by 4
- Source clock divided by 8
- Source clock divided by 16

MB95100B Series

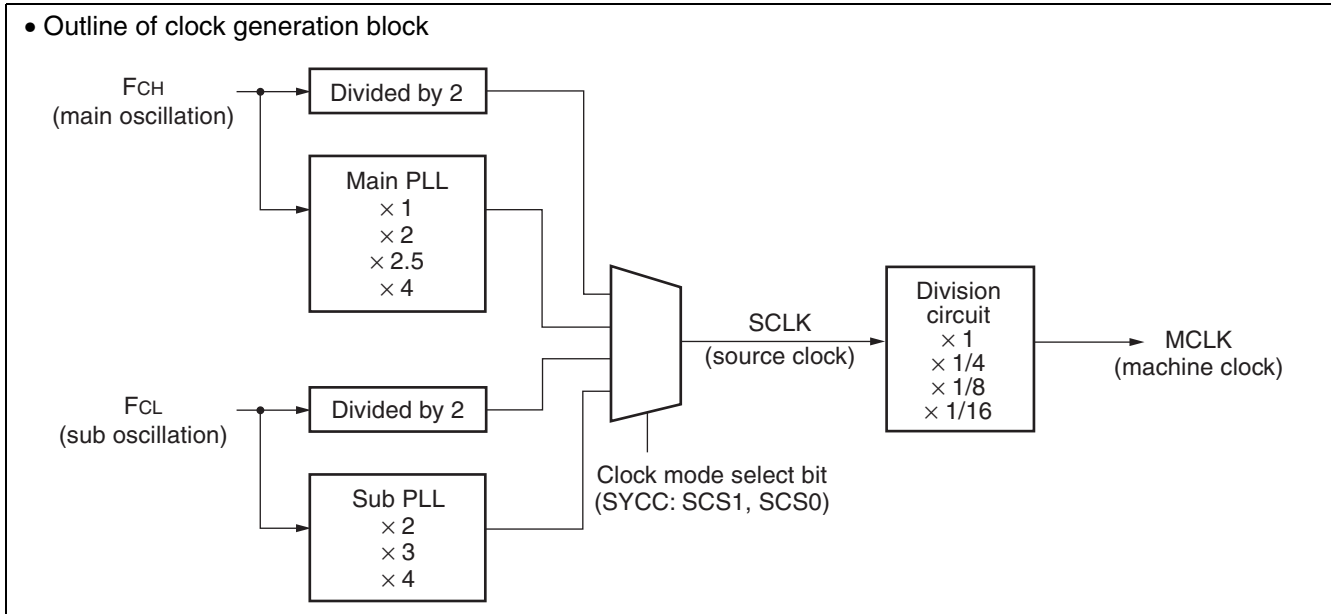

- Operating voltage - Operating frequency (When $T_A = -10\text{ }^\circ\text{C}$ to $+85\text{ }^\circ\text{C}$)

- MB95107B, MB95R107B

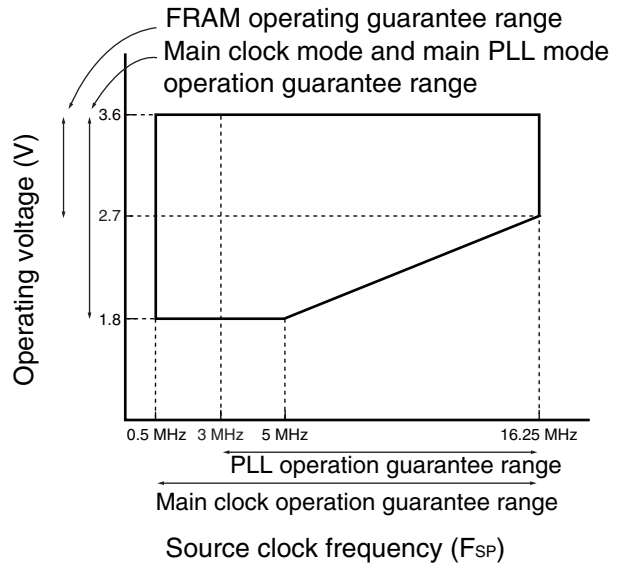
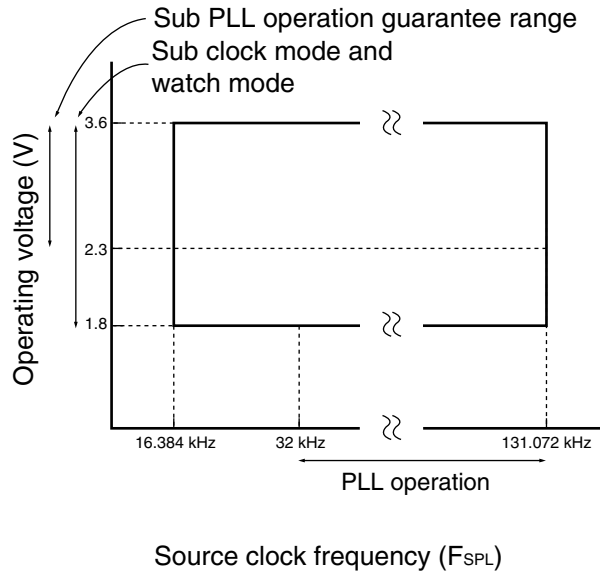

- MB95F108BS, MB95F108BW, MB95D108BS, MB95D108BW

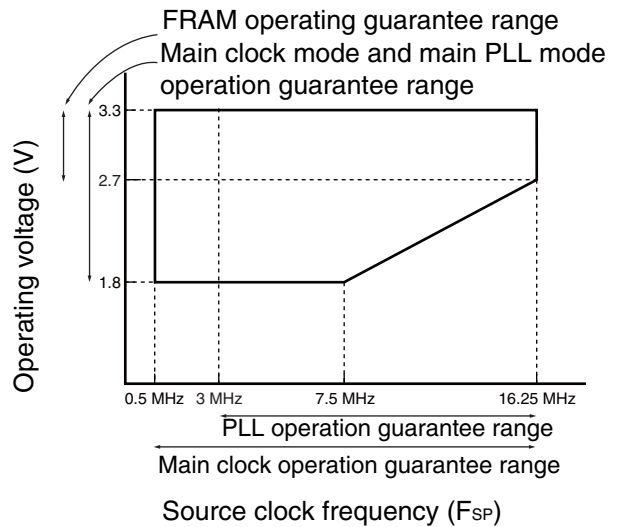
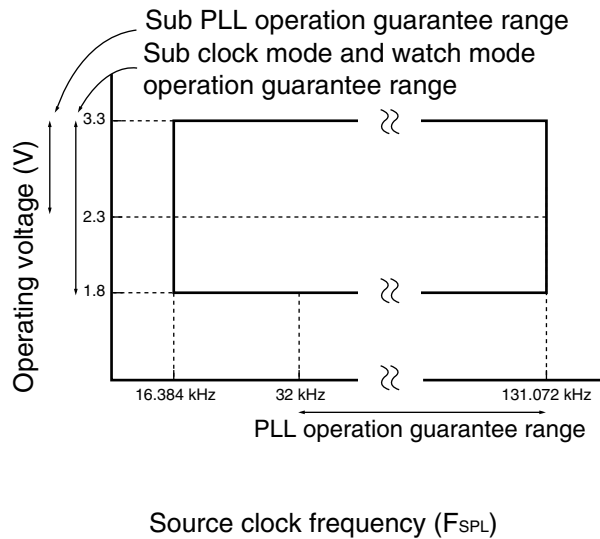

MB95100B Series

- Operating voltage - Operating frequency (When $T_A = -40\text{ }^\circ\text{C}$ to $+85\text{ }^\circ\text{C}$)

- MB95107B, MB95R107B

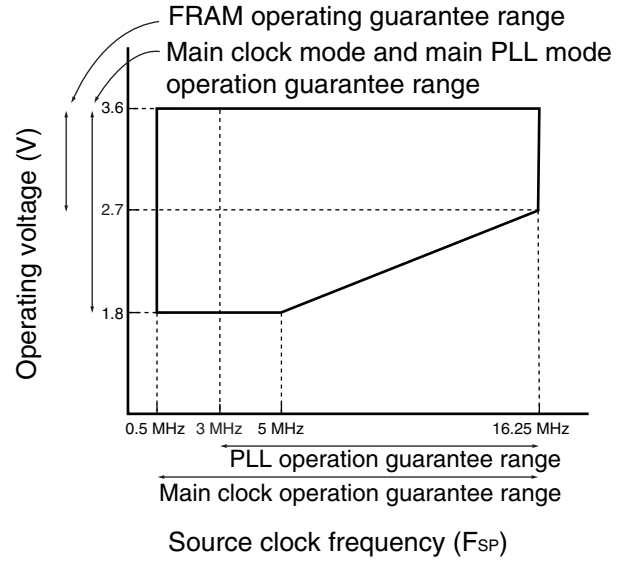
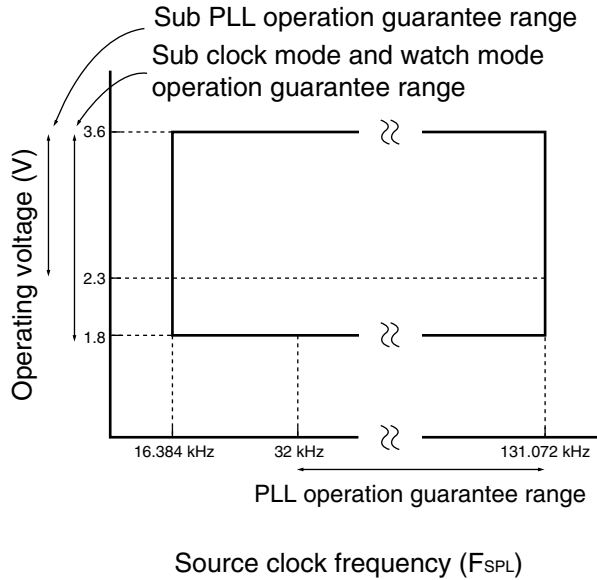

- MB95F108BS, MB95F108BW, MB95D108BS, MB95D108BW

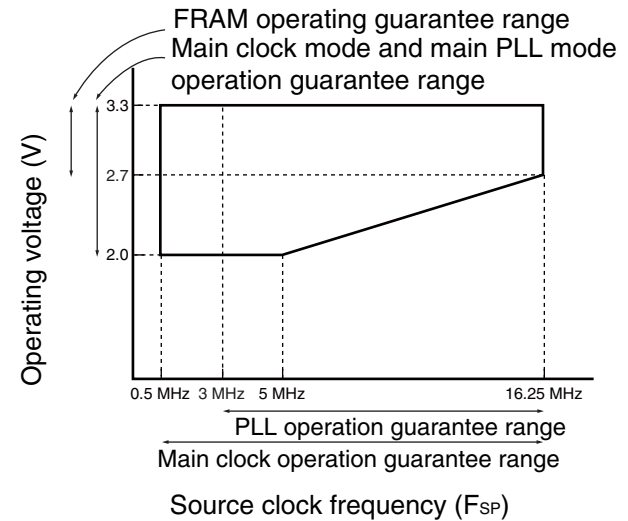
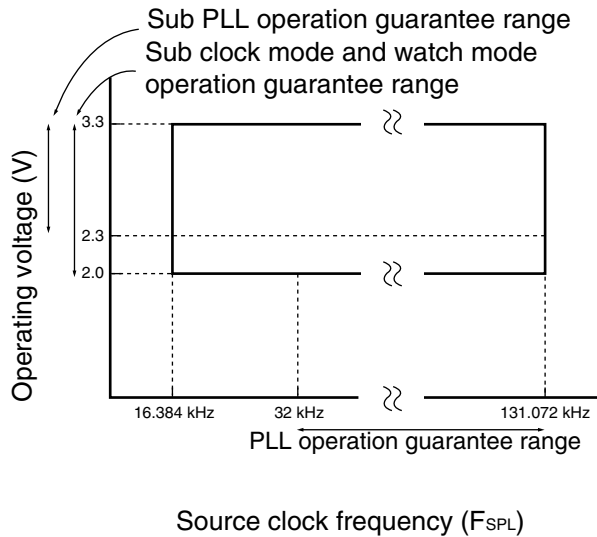

• Operating voltage - Operating frequency ($T_A = +5\text{ }^\circ\text{C}$ to $+35\text{ }^\circ\text{C}$)

• MB95FV100D-101

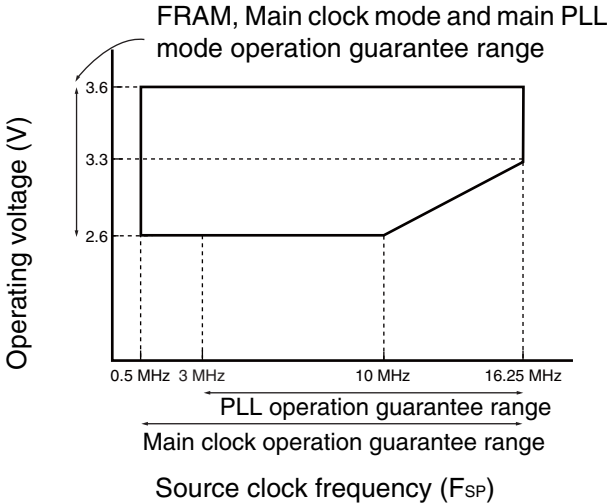
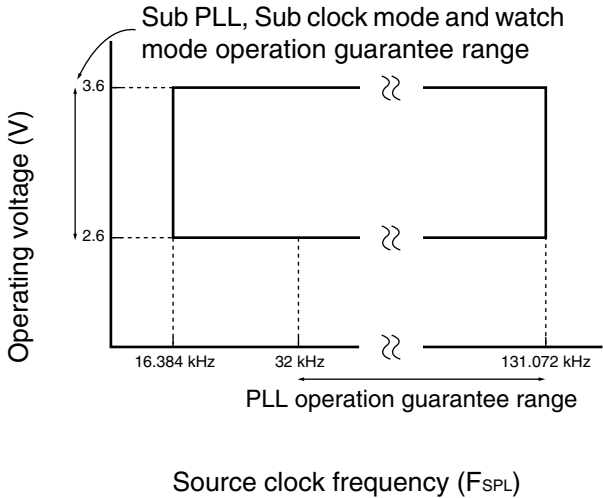

MB95100B Series

- Main PLL operation frequency

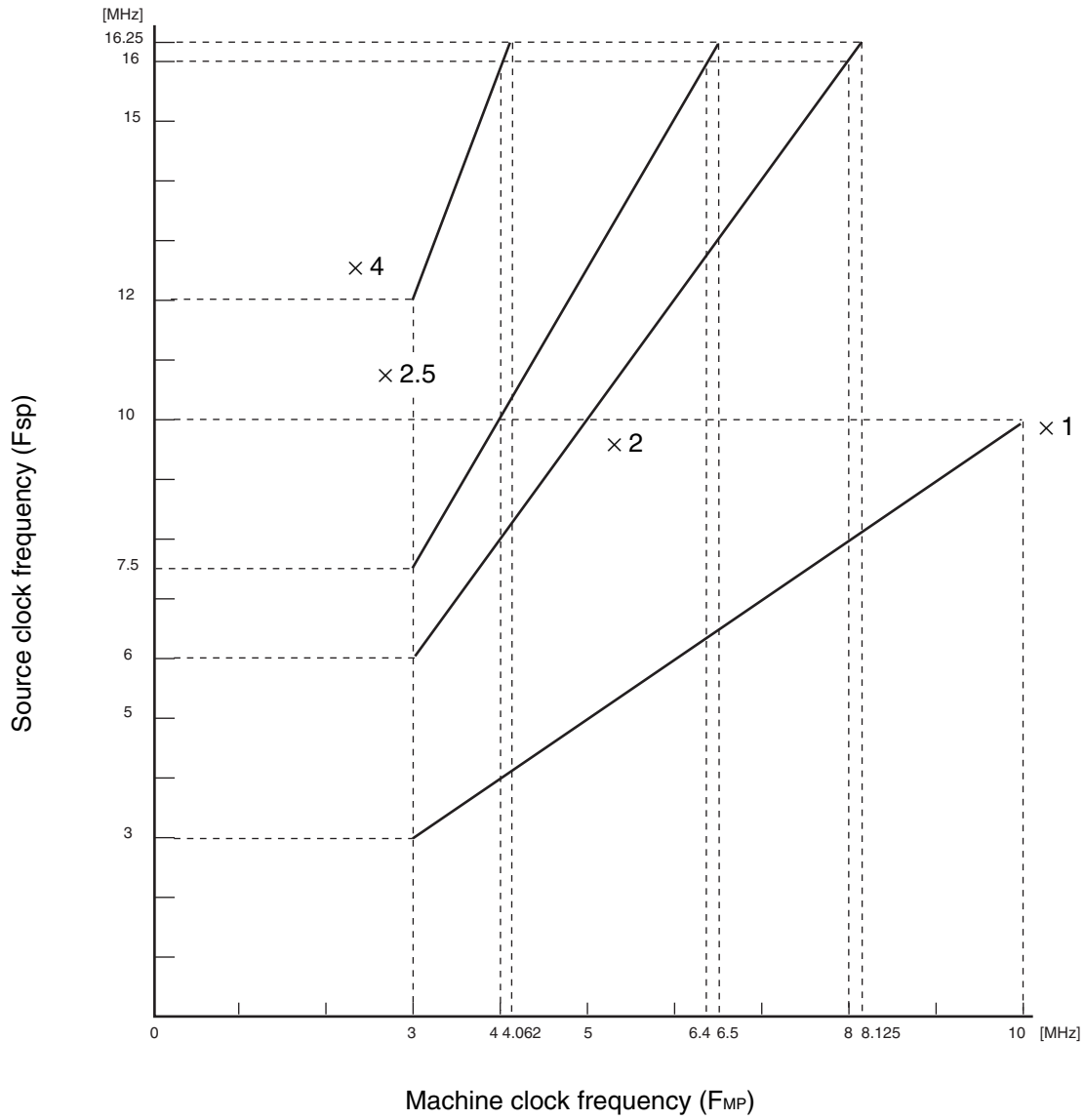

(3) External Reset

($V_{CC} = 3.3\text{ V}$, $A_{V_{SS}} = V_{SS} = 0.0\text{ V}$, $T_A = -40\text{ }^{\circ}\text{C}$ to $+85\text{ }^{\circ}\text{C}$)

Parameter	Symbol	Value		Unit	Remarks
		Min	Max		
$\overline{\text{RST}}$ "L" level pulse width	t_{RSTL}	$2 t_{\text{MCLK}}^{*1}$	—	ns	At normal operating
		Oscillation time of oscillator ^{*2} + $2 t_{\text{MCLK}}^{*1}$	—	ns	At stop mode, sub clock mode, sub sleep mode, and watch mode

*1 : Refer to "(2) Source Clock/Machine Clock" for t_{MCLK} .

*2 : Oscillation start time of oscillator is the time that the amplitude reaches 90 %. In the crystal oscillator, the oscillation time is between several ms and tens of ms. In ceramic oscillators, the oscillation time is between hundreds of μs and several ms. In the external clock, the oscillation time is 0 ms.

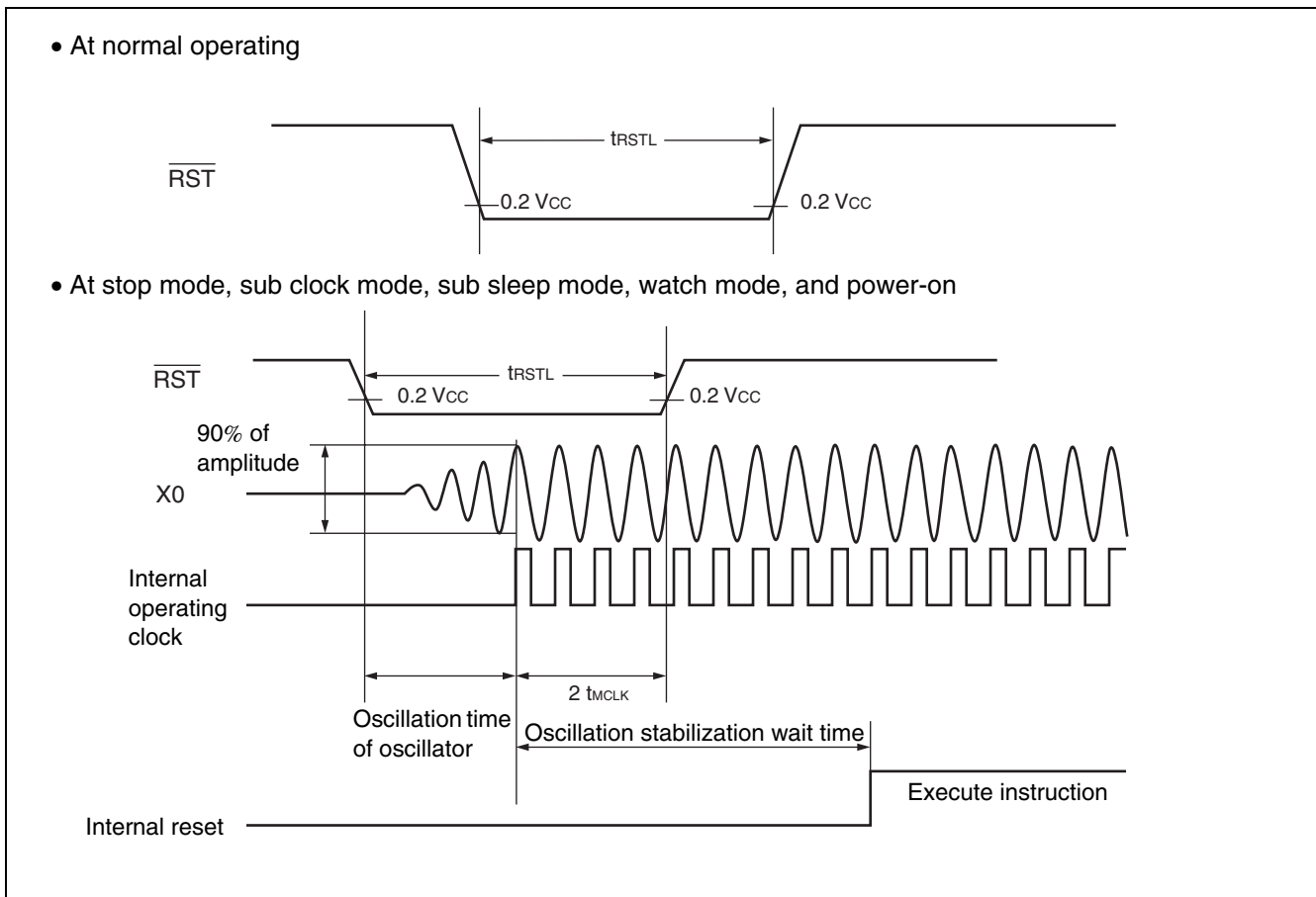

MB95100B Series

(4) Power-on Reset

($A_{V_{SS}} = V_{SS} = 0.0 \text{ V}$, $T_A = -40 \text{ }^\circ\text{C}$ to $+85 \text{ }^\circ\text{C}$)

Parameter	Symbol	Conditions	Value		Unit	Remarks
			Min	Max		
Power supply rising time	t_R	—	—	36	ms	
Power supply cutoff time	t_{OFF}	—	1	—	ms	Waiting time until power-on

Note : The power supply must be turned on within the selected oscillation stabilization time.

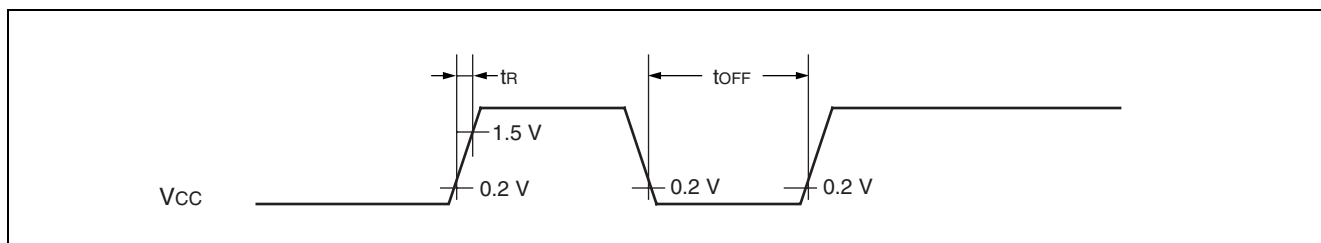

Note : Sudden change of power supply voltage may activate the power-on reset function. When changing power supply voltages during operation, set the slope of rising within 20 mV/ms as shown below.

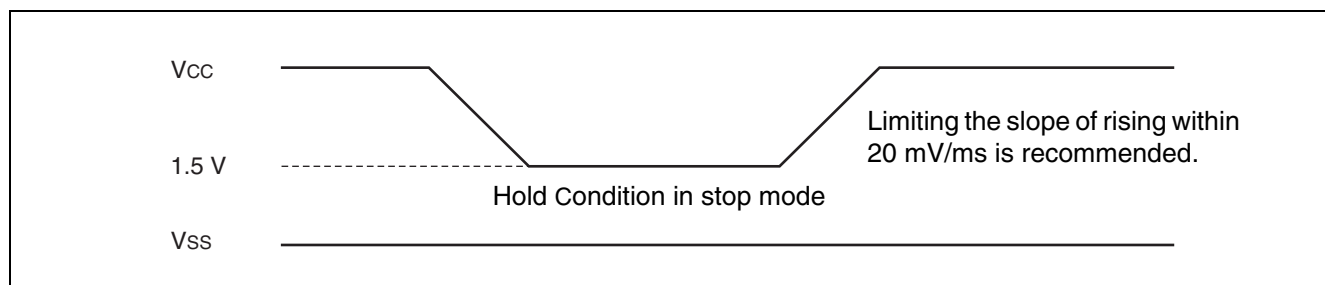

(5) Peripheral Input Timing

($V_{CC} = 3.3\text{ V}$, $AV_{SS} = V_{SS} = 0.0\text{ V}$, $T_A = -40\text{ }^{\circ}\text{C}$ to $+85\text{ }^{\circ}\text{C}$)

Parameter	Symbol	Pin name	Value		Unit
			Min	Max	
Peripheral input "H" pulse width	t_{LIH}	INT00 to INT07, INT10 to INT13, EC0, EC1, TI0, TRG0/ADTG, TRG1	$2 t_{MCLK}^*$	—	ns
Peripheral input "L" pulse width	t_{HIL}		$2 t_{MCLK}^*$	—	ns

* : Refer to "(2) Source Clock/Machine Clock" for t_{MCLK} .

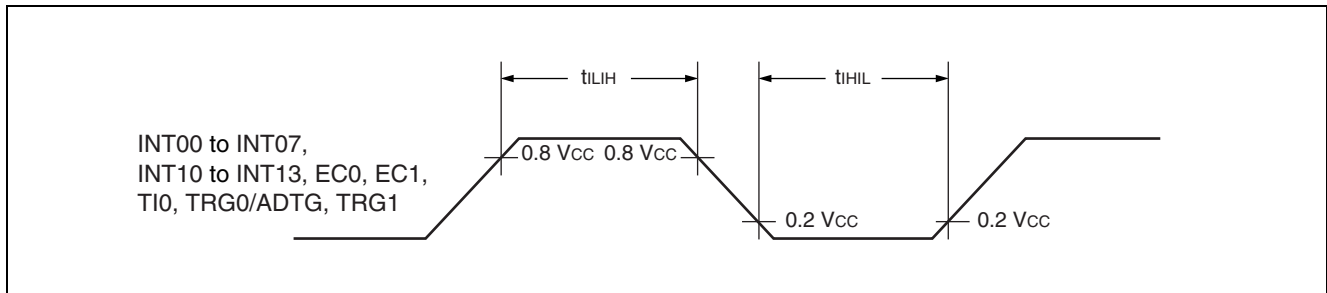

MB95100B Series

(6) UART/SIO, Serial I/O Timing

($V_{CC} = 3.3\text{ V}$, $AV_{SS} = V_{SS} = 0.0\text{ V}$, $T_A = -40\text{ }^\circ\text{C}$ to $+85\text{ }^\circ\text{C}$)

Parameter	Symbol	Pin name	Conditions	Value		Unit
				Min	Max	
Serial clock cycle time	t_{SCYC}	UCK0	Internal clock operation output pin : $C_L = 80\text{ pF} + 1\text{TTL}$.	$4 t_{MCLK}^*$	—	ns
UCK ↓ → UO time	t_{SLOV}	UCK0, UO0		- 190	+ 190	ns
Valid UI → UCK ↑	t_{IVSH}	UCK0, UI0		$2 t_{MCLK}^*$	—	ns
UCK ↑ → valid UI hold time	t_{SHIX}	UCK0, UI0		$2 t_{MCLK}^*$	—	ns
Serial clock "H" pulse width	t_{SHSL}	UCK0	External clock operation output pin : $C_L = 80\text{ pF} + 1\text{TTL}$.	$4 t_{MCLK}^*$	—	ns
Serial clock "L" pulse width	t_{SLSH}	UCK0		$4 t_{MCLK}^*$	—	ns
UCK ↓ → UO time	t_{SLOV}	UCK0, UO0		0	190	ns
Valid UI → UCK ↑	t_{IVSH}	UCK0, UI0		$2 t_{MCLK}^*$	—	ns
UCK ↑ → valid UI hold time	t_{SHIX}	UCK0, UI0	$2 t_{MCLK}^*$	—	ns	

* : Refer to "(2) Source Clock/Machine Clock" for t_{MCLK} .

• Internal shift clock mode

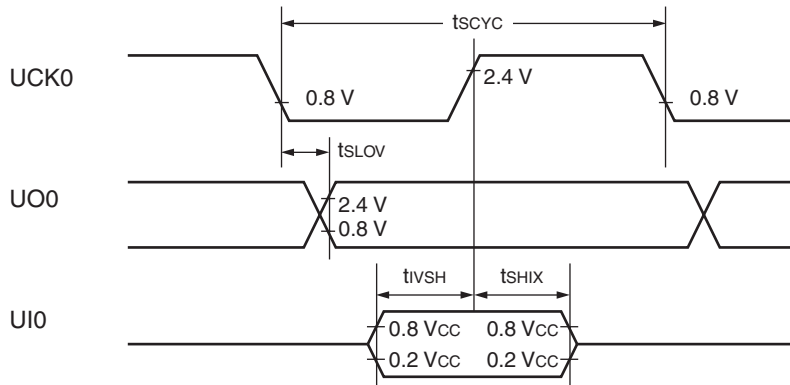

• External shift clock mode

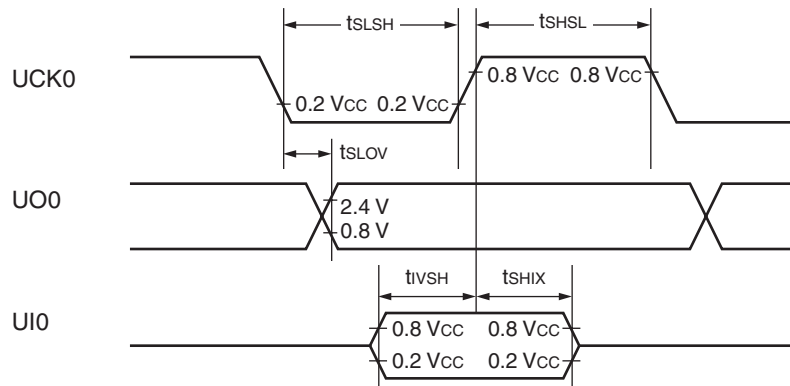

(7) LIN-UART Timing

Sampling at the rising edge of sampling clock*1 and prohibited serial clock delay*2

(ESCR register : SCES bit = 0, ECCR register : SCDE bit = 0)

(V_{CC} = 3.3 V, AV_{SS} = V_{SS} = 0.0 V, T_A = -40 °C to + 85 °C)

Parameter	Symbol	Pin name	Conditions	Value		Unit
				Min	Max	
Serial clock cycle time	t _{SCYC}	SCK	Internal clock operation output pin : C _L = 80 pF + 1 TTL.	5 t _{MCLK} *3	—	ns
SCK ↑→ SOT delay time	t _{SLOVI}	SCK, SOT		-95	+ 95	ns
Valid SIN→SCK↑	t _{IVSHI}	SCK, SIN		t _{MCLK} *3 + 190	—	ns
SCK↑→ valid SIN hold time	t _{SHIXI}	SCK, SIN		0	—	ns
Serial clock "L" pulse width	t _{SLSH}	SCK	External clock operation output pin : C _L = 80 pF + 1 TTL.	3 t _{MCLK} *3 - t _R	—	ns
Serial clock "H" pulse width	t _{SHSL}	SCK		t _{MCLK} *3 + 95	—	ns
SCK ↓→SOT delay time	t _{SLOVE}	SCK, SOT		—	2 t _{MCLK} *3 + 95	ns
Valid SIN→SCK↑	t _{IVSHE}	SCK, SIN		190	—	ns
SCK↑→ valid SIN hold time	t _{SHIXE}	SCK, SIN		t _{MCLK} *3 + 95	—	ns
SCK fall time	t _F	SCK		—	10	ns
SCK rise time	t _R	SCK		—	10	ns

*1 : Provide switch function whether sampling of reception data is performed at rising edge or falling edge of the serial clock.

*2 : Serial clock delay function is used to delay half clock for the output signal of serial clock.

*3 : Refer to "(2) Source Clock/Machine Clock" for t_{MCLK}.

MB95100B Series

- Internal shift clock mode

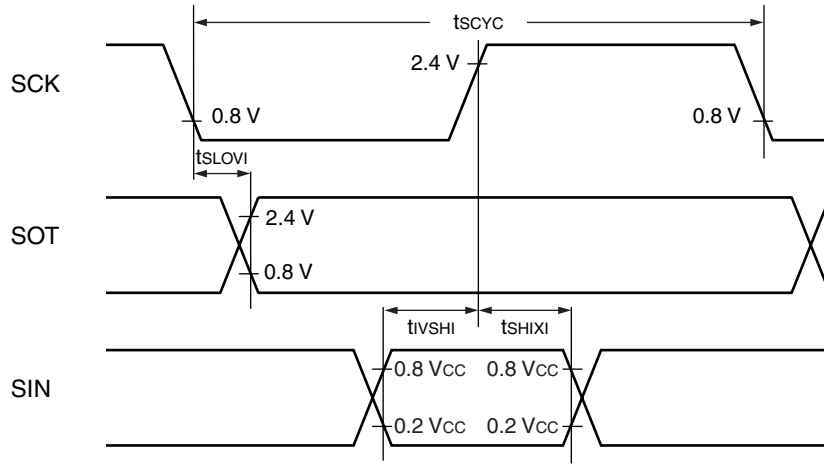

- External shift clock mode

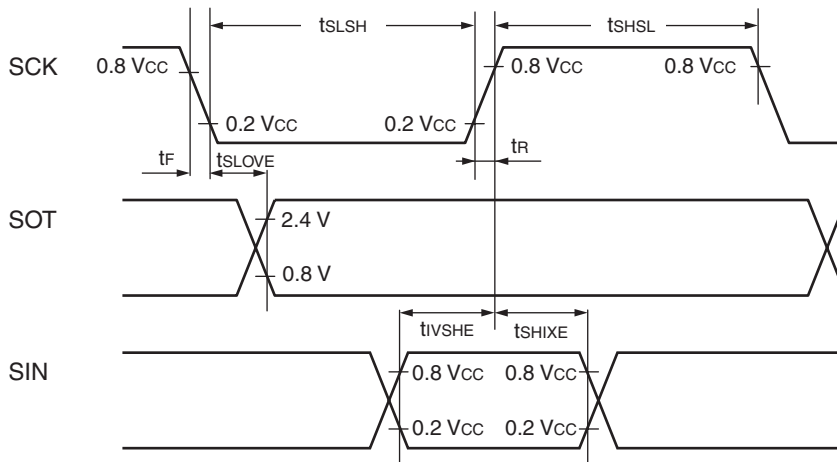

MB95100B Series

Sampling at the falling edge of sampling clock*1 and prohibited serial clock delay*2
(ESCR register : SCES bit = 1, ECCR register : SCDE bit = 0)

($V_{CC} = 3.3\text{ V}$, $AV_{SS} = V_{SS} = 0.0\text{ V}$, $T_A = -40\text{ }^\circ\text{C}$ to $+85\text{ }^\circ\text{C}$)

Parameter	Symbol	Pin name	Conditions	Value		Unit
				Min	Max	
Serial clock cycle time	t_{SCYC}	SCK	Internal clock operation output pin : $C_L = 80\text{ pF} + 1\text{ TTL}$.	$5\ t_{MCLK}^{*3}$	—	ns
SCK \uparrow →SOT delay time	t_{SHOVI}	SCK, SOT		-95	+95	ns
Valid SIN→SCK \downarrow	t_{IVSLI}	SCK, SIN		$t_{MCLK}^{*3} + 190$	—	ns
SCK \downarrow → valid SIN hold time	t_{SLIXI}	SCK, SIN		0	—	ns
Serial clock "H" pulse width	t_{SHSL}	SCK	External clock operation output pin : $C_L = 80\text{ pF} + 1\text{ TTL}$.	$3\ t_{MCLK}^{*3} - t_R$	—	ns
Serial clock "L" pulse width	t_{SLSH}	SCK		$t_{MCLK}^{*3} + 95$	—	ns
SCK \uparrow →SOT delay time	t_{SHOVE}	SCK, SOT		—	$2\ t_{MCLK}^{*3} + 95$	ns
Valid SIN→SCK \downarrow	t_{IVSLE}	SCK, SIN		190	—	ns
SCK \downarrow → valid SIN hold time	t_{SLIXE}	SCK, SIN		$t_{MCLK}^{*3} + 95$	—	ns
SCK fall time	t_F	SCK		—	10	ns
SCK rise time	t_R	SCK		—	10	ns

*1 : Provide switch function whether sampling of reception data is performed at rising edge or falling edge of the serial clock.

*2 : Serial clock delay function is used to delay half clock for the output signal of serial clock.

*3 : Refer to "(2) Source Clock/Machine Clock" for t_{MCLK} .

MB95100B Series

- Internal shift clock mode

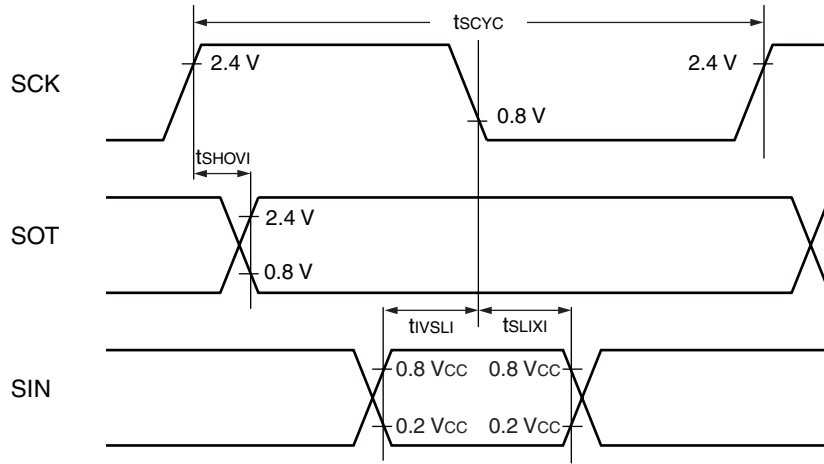

- External shift clock mode

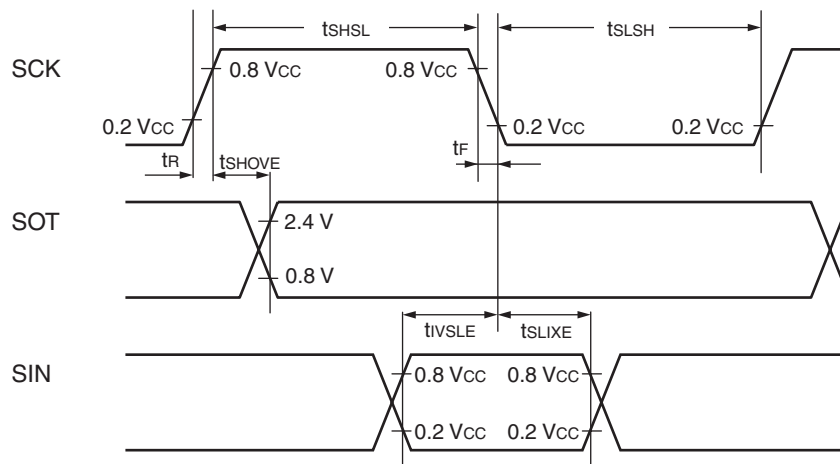

MB95100B Series

Sampling at the rising edge of sampling clock*¹ and enabled serial clock delay*²
 (ESCR register : SCES bit = 0, ECCR register : SCDE bit = 1)

($V_{CC} = 3.3\text{ V}$, $AV_{SS} = V_{SS} = 0.0\text{ V}$, $T_A = -40\text{ }^\circ\text{C}$ to $+85\text{ }^\circ\text{C}$)

Parameter	Symbol	Pin name	Conditions	Value		Unit
				Min	Max	
Serial clock cycle time	t_{SCYC}	SCK	Internal clock operation output pin : $C_L = 80\text{ pF} + 1\text{ TTL}$.	$5 t_{MCLK}^{*3}$	—	ns
SCK \uparrow → SOT delay time	t_{SHOVI}	SCK, SOT		-95	+95	ns
Valid SIN→SCK \downarrow	t_{IVSLI}	SCK, SIN		$t_{MCLK}^{*3} + 190$	—	ns
SCK \downarrow → valid SIN hold time	t_{SLIXI}	SCK, SIN		0	—	ns
SOT→SCK \downarrow delay time	t_{SOVLI}	SCK, SOT		—	$4 t_{MCLK}^{*3}$	ns

*1 : Provide switch function whether sampling of reception data is performed at rising edge or falling edge of the serial clock.

*2 : Serial clock delay function is used to delay half clock for the output signal of serial clock.

*3 : Refer to “(2) Source Clock/Machine Clock” for t_{MCLK} .

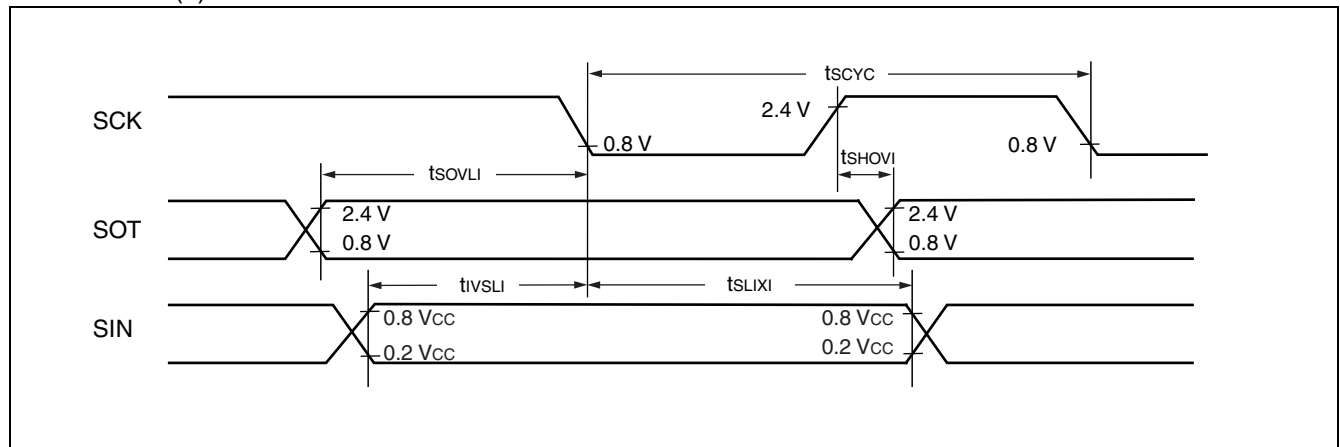

MB95100B Series

Sampling at the falling edge of sampling clock*1 and enabled serial clock delay*2
 (ESCR register : SCES bit = 1, ECCR register : SCDE bit = 1)

($V_{CC} = 3.3\text{ V}$, $AV_{SS} = V_{SS} = 0.0\text{ V}$, $T_A = -40\text{ }^\circ\text{C}$ to $+85\text{ }^\circ\text{C}$)

Parameter	Symbol	Pin name	Conditions	Value		Unit
				Min	Max	
Serial clock cycle time	t_{SCYC}	SCK	Internal clock operating output pin : $C_L = 80\text{ pF} + 1\text{ TTL}$.	$5 t_{MCLK}^{*3}$	—	ns
SCK↓→SOT delay time	t_{SLOVI}	SCK, SOT		-95	+95	ns
Valid SIN→SCK↑	t_{VSHI}	SCK, SIN		$t_{MCLK}^{*3} + 190$	—	ns
SCK↑ → valid SIN hold time	t_{SHIXI}	SCK, SIN		0	—	ns
SOT→SCK↑ delay time	t_{SOVHI}	SCK, SOT		—	$4 t_{MCLK}^{*3}$	ns

*1 : Provide switch function whether sampling of reception data is performed at rising edge or falling edge of the serial clock.

*2 : Serial clock delay function is used to delay half clock for the output signal of serial clock.

*3 : Refer to “(2) Source Clock/Machine Clock” for t_{MCLK} .

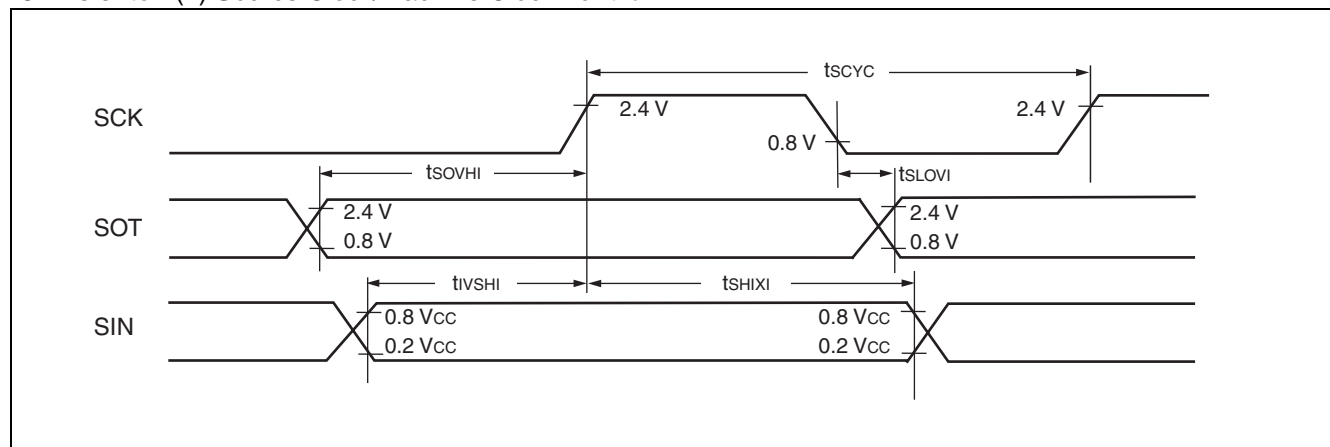

(8) I²C Timing

(V_{CC} = 3.3 V, AV_{SS} = V_{SS} = 0.0 V, T_A = -40 °C to +85 °C)

Parameter	Symbol	Pin name	Conditions	Value				Unit
				Standard-mode		Fast-mode		
				Min	Max	Min	Max	
SCL clock frequency	f _{SCL}	SCL0	R = 1.7 kΩ, C = 50 pF*1	0	100	0	400	kHz
(Repeat) Start condition hold time SDA ↓ → SCL ↓	t _{HD;STA}	SCL0 SDA0		4.0	—	0.6	—	μs
SCL clock "L" width	t _{LOW}	SCL0		4.7	—	1.3	—	μs
SCL clock "H" width	t _{HIGH}	SCL0		4.0	—	0.6	—	μs
(Repeat) Start condition set-up time SCL ↑ → SDA ↓	t _{SU;STA}	SCL0 SDA0		4.7	—	0.6	—	μs
Data hold time SCL ↓ → SDA ↓ ↑	t _{HD;DAT}	SCL0 SDA0		0	3.45*2	0	0.9*3	μs
Data setup time SDA ↓ ↑ → SCL ↑	t _{SU;DAT}	SCL0 SDA0		0.25	—	0.1	—	μs
Stop condition setup time SCL ↑ → SDA ↑	t _{SU;STO}	SCL0 SDA0		4	—	0.6	—	μs
Bus free time between stop condition and start condition	t _{BUF}	SCL0 SDA0		4.7	—	1.3	—	μs

*1 : R, C : Pull-up resistor and load capacitor of the SCL and SDA lines.

*2 : The maximum t_{HD;DAT} have only to be met if the device dose not stretch the "L" width (t_{LOW}) of the SCL signal.

*3 : A fast-mode I²C-bus device can be used in a standard-mode I²C-bus system, but the requirement t_{SU;DAT} ≥ 250 ns must then be met.

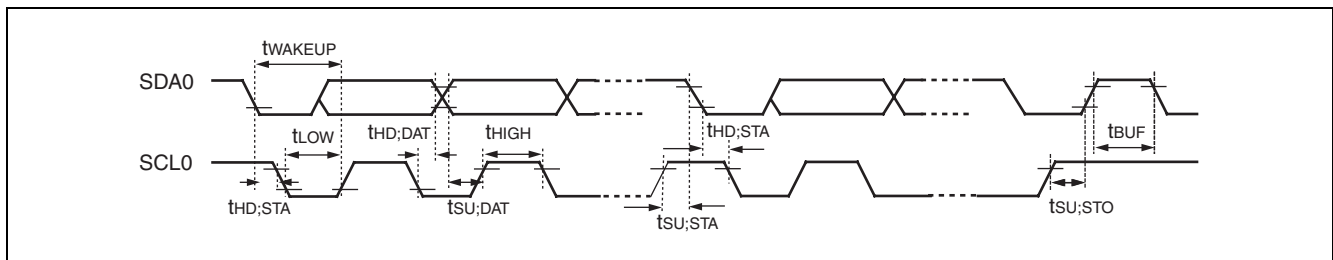

MB95100B Series

($V_{CC} = 3.3\text{ V}$, $AV_{SS} = V_{SS} = 0.0\text{ V}$, $T_A = -40\text{ }^\circ\text{C}$ to $+85\text{ }^\circ\text{C}$)

Parameter	Symbol	Pin name	Conditions	Value*2		Unit	Remarks
				Min	Max		
SCL clock "L" width	t_{LOW}	SCL0	R = 1.7 k Ω , C = 50 pF*1	$(2 + nm / 2) t_{MCLK} - 20$	—	ns	Master mode
SCL clock "H" width	t_{HIGH}	SCL0		$(nm / 2) t_{MCLK} - 20$	$(nm / 2) t_{MCLK} + 20$	ns	Master mode
Start condition hold time	$t_{HD;STA}$	SCL0 SDA0		$(-1 + nm / 2) t_{MCLK} - 20$	$(-1 + nm) t_{MCLK} + 20$	ns	Master mode Maximum value is applied when m, n = 1, 8. Otherwise, the minimum value is applied.
Stop condition setup time	$t_{SU;STO}$	SCL0 SDA0		$(1 + nm / 2) t_{MCLK} - 20$	$(1 + nm / 2) t_{MCLK} + 20$	ns	Master mode
Start condition setup time	$t_{SU;STA}$	SCL0 SDA0		$(1 + nm / 2) t_{MCLK} - 20$	$(1 + nm / 2) t_{MCLK} + 20$	ns	Master mode
Bus free time between stop condition and start condition	t_{BUF}	SCL0 SDA0		$(2 nm + 4) t_{MCLK} - 20$	—	ns	
Data hold time	$t_{HD;DAT}$	SCL0 SDA0		$3 t_{MCLK} - 20$	—	ns	Master mode
Data setup time	$t_{SU;DAT}$	SCL0 SDA0		$(-2 + nm / 2) t_{MCLK} - 20$	$(-1 + nm / 2) t_{MCLK} + 20$	ns	Master mode When assuming that "L" of SCL is not extended, the minimum value is applied to first bit of continuous data. Otherwise, the maximum value is applied.
Setup time between clearing interrupt and SCL rising	$t_{SU;INT}$	SCL0		$(nm / 2) t_{MCLK} - 20$	$(1 + nm / 2) t_{MCLK} + 20$	ns	Minimum value is applied to interrupt at 9th SCL \downarrow . Maximum value is applied to interrupt at 8th SCL \downarrow .
SCL clock "L" width	t_{LOW}	SCL0		$4 t_{MCLK} - 20$	—	ns	At reception
SCL clock "H" width	t_{HIGH}	SCL0		$4 t_{MCLK} - 20$	—	ns	At reception
Start condition detection	$t_{HD;STA}$	SCL0 SDA0		$2 t_{MCLK} - 20$	—	ns	Undetected when 1 t_{MCLK} is used at reception

(Continued)

MB95100B Series

(Continued)

($V_{CC} = 3.3\text{ V}$, $AV_{SS} = V_{SS} = 0.0\text{ V}$, $T_A = -40\text{ }^\circ\text{C}$ to $+85\text{ }^\circ\text{C}$)

Parameter	Symbol	Pin name	Conditions	Value*2		Unit	Remarks
				Min	Max		
Stop condition detection	$t_{SU;STO}$	SCL0 SDA0	R = 1.7 k Ω , C = 50 pF*1	$2 t_{MCLK} - 20$	—	ns	Undetected when 1 t_{MCLK} is used at reception
Restart condition detection condition	$t_{SU;STA}$	SCL0 SDA0		$2 t_{MCLK} - 20$	—	ns	Undetected when 1 t_{MCLK} is used at reception
Bus free time	t_{BUF}	SCL0 SDA0		$2 t_{MCLK} - 20$	—	ns	At reception
Data hold time	$t_{HD;DAT}$	SCL0 SDA0		$2 t_{MCLK} - 20$	—	ns	At slave transmission mode
Data setup time	$t_{SU;DAT}$	SCL0 SDA0		$t_{LOW} - 3 t_{MCLK} - 20$	—	ns	At slave transmission mode
Data hold time	$t_{HD;DAT}$	SCL0 SDA0		0	—	ns	At reception
Data setup time	$t_{SU;DAT}$	SCL0 SDA0		$t_{MCLK} - 20$	—	ns	At reception
SDA \downarrow →SCL \uparrow (at wakeup function)	t_{WAKEUP}	SCL0 SDA0		Oscillation stabilization wait time + $2 t_{MCLK} - 20$	—	ns	

*1 : R, C : Pull-up resistor and load capacitor of the SCL and SDA lines.

*2 : • Refer to “(2) Source Clock/Machine Clock” for t_{MCLK} .

• m is CS4 bit and CS3 bit (bit 4 and bit 3) of clock control register (ICCR) .

• n is CS2 bit to CS0 bit (bit 2 to bit 0) of clock control register (ICCR) .

• Actual timing of I²C is determined by m and n values set by the machine clock (t_{MCLK}) and CS4 to CS0 of ICCR0 register.

• Standard-mode :

m and n can be set at the range : 0.9 MHz < t_{MCLK} (machine clock) < 10 MHz.

Setting of m and n determines the machine clock that can be used below.

(m, n) = (1, 8) : 0.9 MHz < $t_{MCLK} \leq 1$ MHz

(m, n) = (1, 22), (5, 4), (6, 4), (7, 4), (8, 4) : 0.9 MHz < $t_{MCLK} \leq 2$ MHz

(m, n) = (1, 38), (5, 8), (6, 8), (7, 8), (8, 8) : 0.9 MHz < $t_{MCLK} \leq 4$ MHz

(m, n) = (1, 98) : 0.9 MHz < $t_{MCLK} \leq 10$ MHz

• Fast-mode :

m and n can be set at the range : 3.3 MHz < t_{MCLK} (machine clock) < 10 MHz.

Setting of m and n determines the machine clock that can be used below.

(m, n) = (1, 8) : 3.3 MHz < $t_{MCLK} \leq 4$ MHz

(m, n) = (1, 22), (5, 4) : 3.3 MHz < $t_{MCLK} \leq 8$ MHz

(m, n) = (6, 4) : 3.3 MHz < $t_{MCLK} \leq 10$ MHz

MB95100B Series

5. A/D Converter

(1) A/D Converter Electrical Characteristics

($AV_{CC} = V_{CC} = 1.8 \text{ V to } 3.3 \text{ V}$ [Flash memory product], $AV_{CC} = V_{CC} = 1.8 \text{ V to } 3.6 \text{ V}$ [MASK ROM product],
 $AV_{SS} = V_{SS} = 0.0 \text{ V}$, $T_A = -40 \text{ }^\circ\text{C to } +85 \text{ }^\circ\text{C}$)

Parameter	Symbol	Value			Unit	Remarks
		Min	Typ	Max		
Resolution	—	—	—	10	bit	
Total error		-3.0	—	+3.0	LSB	
Linearity error		-2.5	—	+2.5	LSB	
Differential linear error		-1.9	—	+1.9	LSB	
Zero transition voltage	V_{OT}	$AV_{SS} - 1.5 \text{ LSB}$	$AV_{SS} + 0.5 \text{ LSB}$	$AV_{SS} + 2.5 \text{ LSB}$	V	Flash memory product : $2.7 \text{ V} \leq AV_{CC} \leq 3.3 \text{ V}$ MASK ROM product : $2.7 \text{ V} \leq AV_{CC} \leq 3.6 \text{ V}$
		$AV_{SS} - 0.5 \text{ LSB}$	$AV_{SS} + 1.5 \text{ LSB}$	$AV_{SS} + 3.5 \text{ LSB}$	V	$1.8 \text{ V} \leq AV_{CC} < 2.7 \text{ V}$
Full-scale transition voltage	V_{FST}	$AVR - 3.5 \text{ LSB}$	$AVR - 1.5 \text{ LSB}$	$AVR + 0.5 \text{ LSB}$	V	Flash memory product : $2.7 \text{ V} \leq AV_{CC} \leq 3.3 \text{ V}$ MASK ROM product : $2.7 \text{ V} \leq AV_{CC} \leq 3.6 \text{ V}$
		$AVR - 2.5 \text{ LSB}$	$AVR - 0.5 \text{ LSB}$	$AVR + 1.5 \text{ LSB}$	V	$1.8 \text{ V} \leq AV_{CC} < 2.7 \text{ V}$
Compare time	—	1.3	—	140	μs	Flash memory product : $2.7 \text{ V} \leq AV_{CC} \leq 3.3 \text{ V}$ MASK ROM product : $2.7 \text{ V} \leq AV_{CC} \leq 3.6 \text{ V}$
		20	—	140	μs	$1.8 \text{ V} \leq AV_{CC} < 2.7 \text{ V}$
Sampling time	—	0.4	—	∞	μs	Flash memory product : $2.7 \text{ V} \leq AV_{CC} \leq 3.3 \text{ V}$ MASK ROM product : $2.7 \text{ V} \leq AV_{CC} \leq 3.6 \text{ V}$ external impedance < at 1.8 k Ω
		30	—	∞	μs	$1.8 \text{ V} \leq AV_{CC} < 2.7 \text{ V}$ external impedance < at 14.8 k Ω
Analog input current	I_{AIN}	-0.3	—	+0.3	μA	
Analog input voltage	V_{AIN}	AV_{SS}	—	AVR	V	
Reference voltage	—	$AV_{SS} + 1.8$	—	AV_{CC}	V	AVR pin
Reference voltage supply current	I_R	—	400	600	μA	AVR pin, During A/D operation
	I_{RH}	—	—	5	μA	AVR pin, At stop mode

(2) Notes on Using A/D Converter

• About the external impedance of analog input and its sampling time

- A/D converter with sample and hold circuit. If the external impedance is too high to keep sufficient sampling time, the analog voltage charged to the internal sample and hold capacitor is insufficient, adversely affecting A/D conversion precision. Therefore, to satisfy the A/D conversion precision standard, consider the relationship between the external impedance and minimum sampling time and either adjust the register value and operating frequency or decrease the external impedance so that the sampling time is longer than the minimum value. Also, if the sampling time cannot be sufficient, connect a capacitor of about 0.1 μF to the analog input pin.

• Analog input equivalent circuit

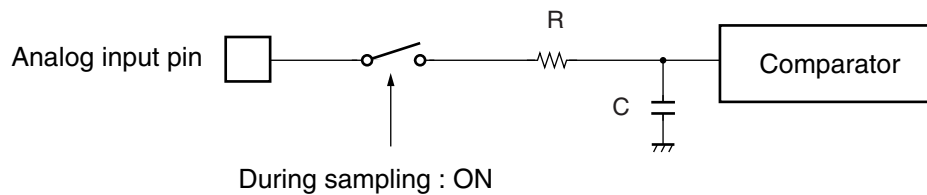

	R	C
$2.7 \text{ V} \leq AV_{CC} \leq 3.6 \text{ V}$	1.7 k Ω (Max)	14.5 pF (Max)
$1.8 \text{ V} \leq AV_{CC} < 2.7 \text{ V}$	84 k Ω (Max)	25.2 pF (Max)

Note : The values are reference values.

• The relationship between external impedance and minimum sampling time

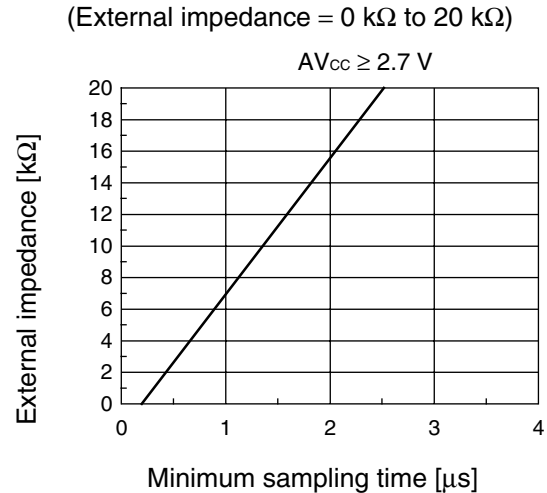
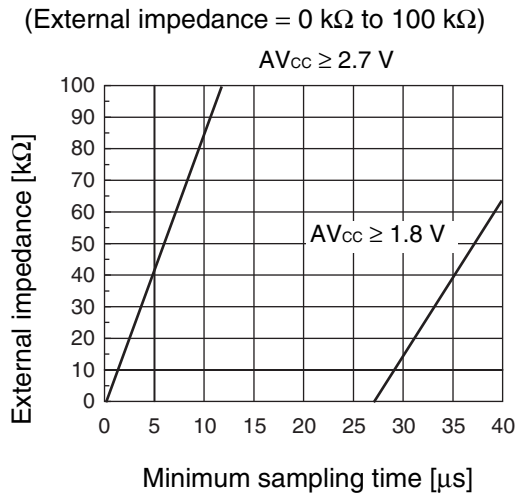

• About errors

As $|AVR - AV_{SS}|$ becomes smaller, values of relative errors grow larger.

(Continued)

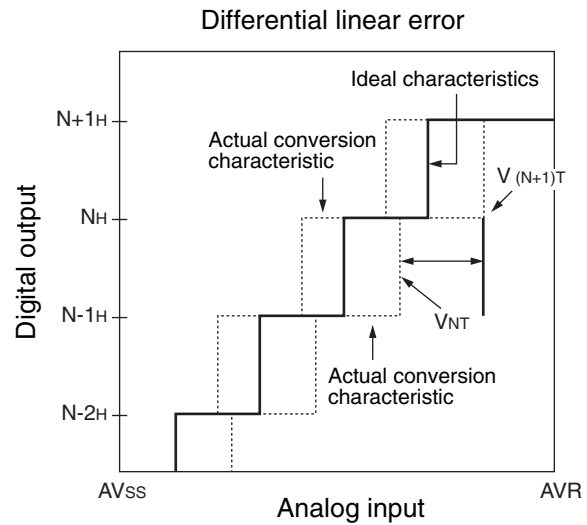
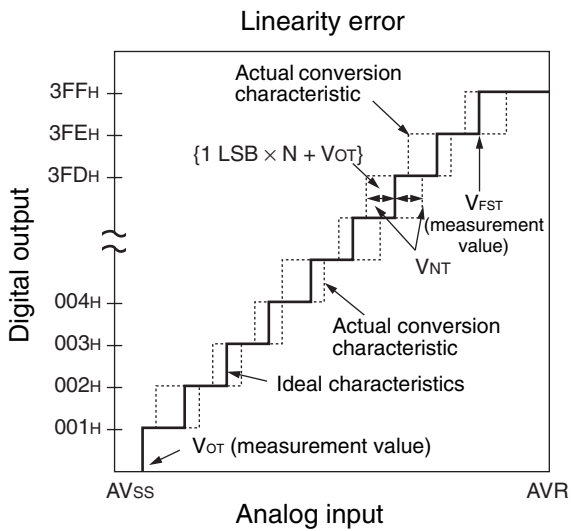
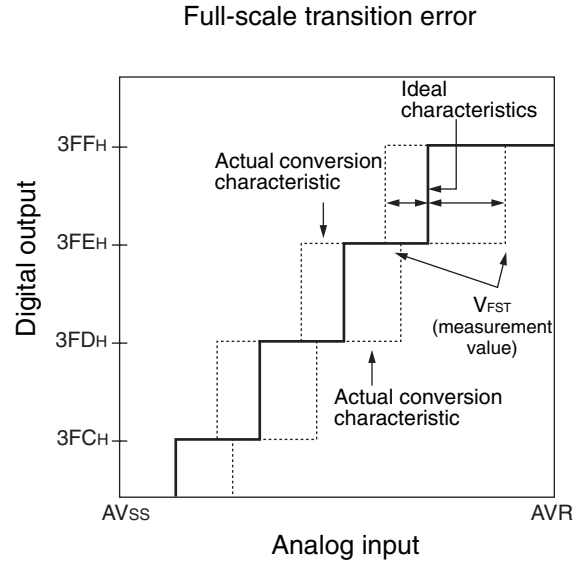
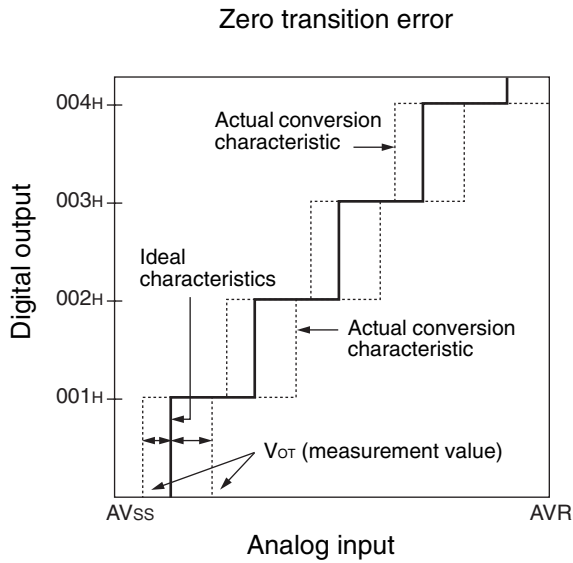

$$\text{Linear error in digital output } N = \frac{V_{NT} - \{1 \text{ LSB} \times N + V_{OT}\}}{1 \text{ LSB}}$$

$$\text{Differential linear error in digital output } N = \frac{V_{(N+1)T} - V_{NT}}{1 \text{ LSB}} - 1$$

N : A/D converter digital output value

V_{NT} : A voltage at which digital output transits from (N - 1) to N.

V_{OT} (Ideal value) = $AV_{SS} + 0.5 \text{ LSB}$ [V]

V_{FST} (Ideal value) = $AVR - 1.5 \text{ LSB}$ [V]

MB95100B Series

6. Flash Memory Program/Erase Characteristics

Parameter	Value			Unit	Remarks
	Min	Typ	Max		
Sector erase time (4K bytes sector)	—	0.2* ¹	3.0* ²	s	Excludes 00 _H programming prior erasure.
Sector erase time (16K bytes sector)	—	0.5* ¹	12.0* ²	s	Excludes 00 _H programming prior erasure.
Byte programming time	—	32	3600	μs	Excludes system-level overhead.
Program/erase cycle	10000	—	—	cycle	
Power supply voltage at program/erase	2.7	—	3.3	V	
Flash memory data retention time	20* ³	—	—	year	Average T _A = +85 °C

*1 : T_A = + 25 °C, V_{CC} = 3.0 V, 10000 cycles

*2 : T_A = + 85 °C, V_{CC} = 2.7 V, 10000 cycles

*3 : This value comes from the technology qualification (using Arrhenius equation to translate high temperature measurements into normalized value at +85 °C) .

7. FRAM Program Characteristics

Parameter	Value			Unit	Remarks
	Min	Typ	Max		
Read/write cycle*	10 ¹⁰	—	—	cycle	
Power supply voltage at read/write	2.7	—	3.6	V	
Data retention time	10	—	—	year	T _A = 0 °C to +55 °C

* : Number of data read/write

■ MASK OPTION

No.	Part number	MB95107B MB95R107B	MB95F108BS MB95D108BS	MB95F108BW MB95D108BW	MB95FV100D-101
	Specifying procedure	Specify when ordering MASK	Setting disabled	Setting disabled	Setting disabled
1	Clock mode select* ¹ • Single-system clock mode • Dual-system clock mode	Selectable	Single-system clock mode	Dual-system clock mode	Changing by the switch on MCU board
2	FRAM* ¹ • With load of FRAM • Without load of FRAM	Specify by part number	Specify by part number	Specify by part number	No
3	Low voltage detection reset* ² • With low voltage detection reset • Without low voltage detection reset	No	No	No	No
4	Clock supervisor* ² • With clock supervisor • Without clock supervisor	No	No	No	No
5	Selection of oscillation stabilization wait time • Selectable the initial value of main clock oscillation stabilization wait time	Selectable 1 : $(2^2 - 2) / F_{CH}$ 2 : $(2^{12} - 2) / F_{CH}$ 3 : $(2^{13} - 2) / F_{CH}$ 4 : $(2^{14} - 2) / F_{CH}$	Fixed to oscillation stabilization wait time of $(2^{14} - 2) / F_{CH}$	Fixed to oscillation stabilization wait time of $(2^{14} - 2) / F_{CH}$	Fixed to oscillation stabilization wait time of $(2^{14} - 2) / F_{CH}$

*1 : Refer to table below about clock mode select and load of FRAM.

*2 : Low voltage detection reset and clock supervisor are options of 5-V products.

Part number	Clock mode select	Load of FRAM
MB95107B/R107B	Single-system	No
	Dual-system	No
MB95F108BS	Single-system	No
MB95D108BS		Yes
MB95F108BW	Dual-system	No
MB95D108BW		Yes
MB95FV100D-101	Single-system	No
	Dual-system	No

MB95100B Series

■ ORDERING INFORMATION

Part number	Package
MB95107BPFV MB95F108BSPFV MB95F108BWPFV MB95R107BPFV MB95D108BSPFV MB95D108BWPFV	64-pin plastic LQFP (FPT-64P-M03)
MB95107BPFM MB95F108BSPFM MB95F108BWPFM MB95R107BPFM MB95D108BSPFM MB95D108BWPFM	64-pin plastic LQFP (FPT-64P-M09)
MB2146-301A (MB95FV100D-101PBT)	MCU board (224-pin plastic PFBGA) (BGA-224P-M08)

MB95100B Series

■ PACKAGE DIMENSIONS

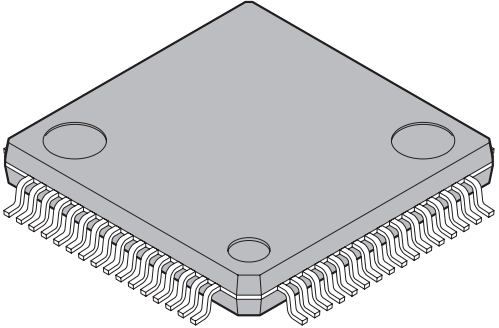
<p>64-pin plastic LQFP</p>  <p>(FPT-64P-M03)</p>	Lead pitch	0.50 mm
	Package width × package length	10.0 × 10.0 mm
	Lead shape	Gullwing
	Sealing method	Plastic mold
	Mounting height	1.70 mm MAX
	Weight	0.32g
	Code (Reference)	P-LFQFP64-10×10-0.50

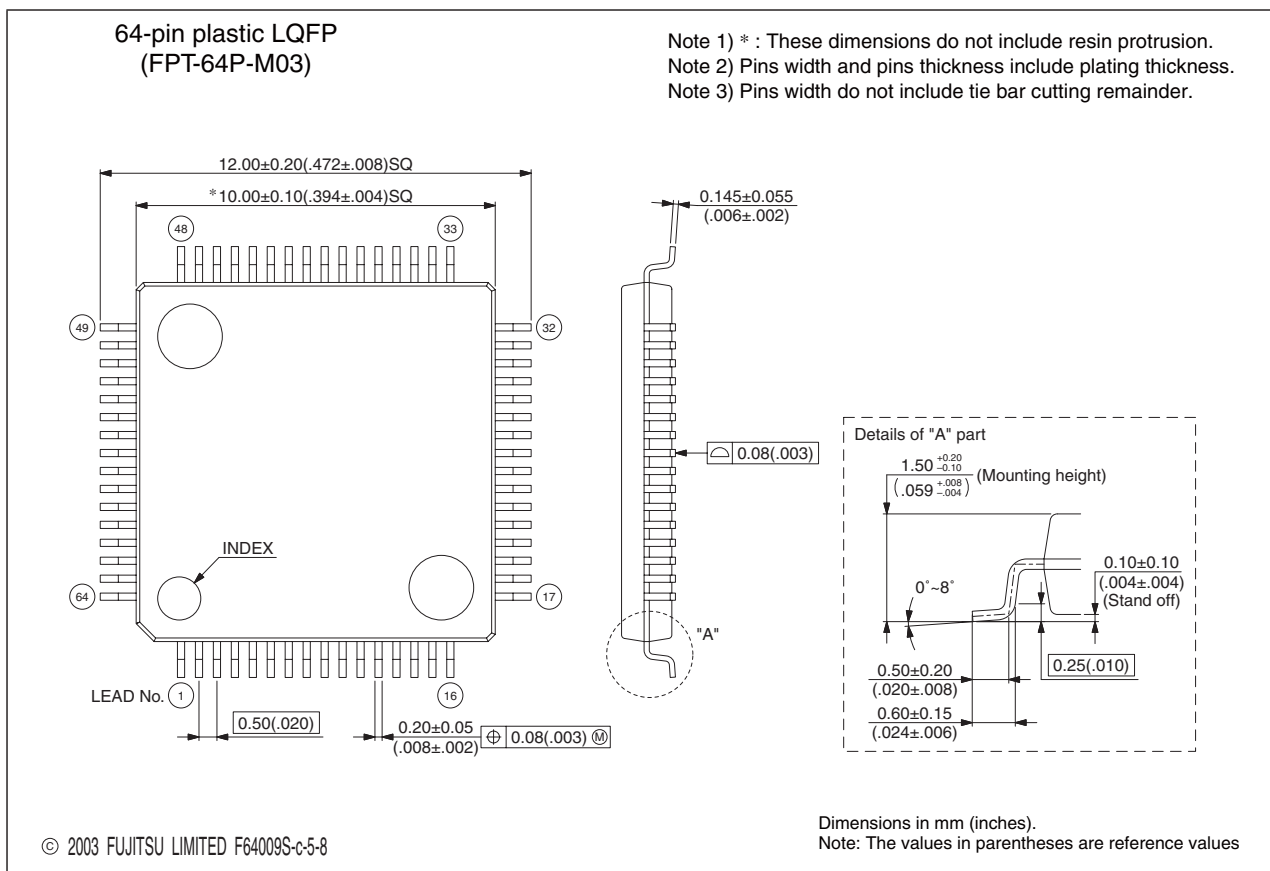

Please confirm the latest Package dimension by following URL.
<http://edevic.fujitsu.com/fj/DATASHEET/ef-ovpkiv.html>

(Continued)

MB95100B Series

(Continued)

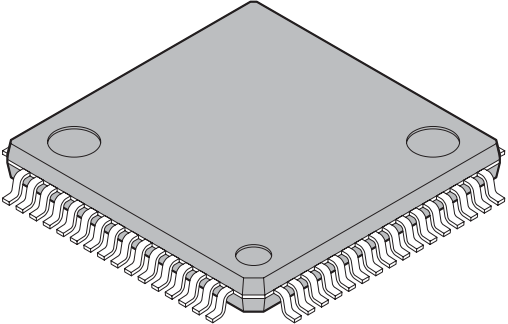
<p>64-pin plastic LQFP</p>  <p>(FPT-64P-M09)</p>	Lead pitch	0.65 mm
	Package width × package length	12 × 12 mm
	Lead shape	Gullwing
	Sealing method	Plastic mold
	Mounting height	1.70 mm MAX
	Code (Reference)	P-LQFP64-12×12-0.65

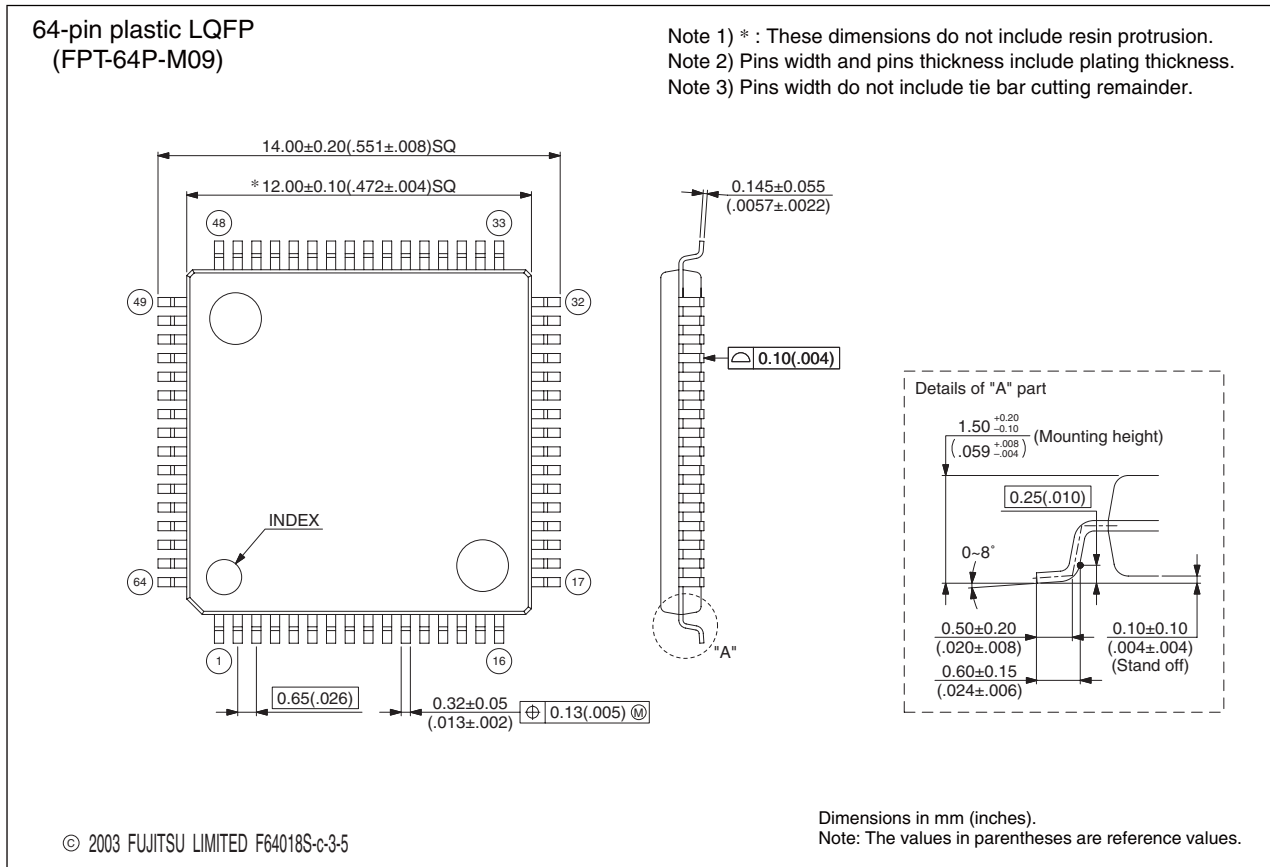

Please confirm the latest Package dimension by following URL.
<http://edevic.fujitsu.com/fj/DATASHEET/ef-ovpkiv.html>

MB95100B Series

The information for microcontroller supports is shown in the following homepage.
<http://www.fujitsu.com/global/services/microelectronics/product/micom/support/index.html>

FUJITSU LIMITED

All Rights Reserved.

The contents of this document are subject to change without notice. Customers are advised to consult with FUJITSU sales representatives before ordering.

The information, such as descriptions of function and application circuit examples, in this document are presented solely for the purpose of reference to show examples of operations and uses of Fujitsu semiconductor device; Fujitsu does not warrant proper operation of the device with respect to use based on such information. When you develop equipment incorporating the device based on such information, you must assume any responsibility arising out of such use of the information. Fujitsu assumes no liability for any damages whatsoever arising out of the use of the information.

Any information in this document, including descriptions of function and schematic diagrams, shall not be construed as license of the use or exercise of any intellectual property right, such as patent right or copyright, or any other right of Fujitsu or any third party or does Fujitsu warrant non-infringement of any third-party's intellectual property right or other right by using such information. Fujitsu assumes no liability for any infringement of the intellectual property rights or other rights of third parties which would result from the use of information contained herein.

The products described in this document are designed, developed and manufactured as contemplated for general use, including without limitation, ordinary industrial use, general office use, personal use, and household use, but are not designed, developed and manufactured as contemplated (1) for use accompanying fatal risks or dangers that, unless extremely high safety is secured, could have a serious effect to the public, and could lead directly to death, personal injury, severe physical damage or other loss (i.e., nuclear reaction control in nuclear facility, aircraft flight control, air traffic control, mass transport control, medical life support system, missile launch control in weapon system), or (2) for use requiring extremely high reliability (i.e., submersible repeater and artificial satellite).

Please note that Fujitsu will not be liable against you and/or any third party for any claims or damages arising in connection with above-mentioned uses of the products.

Any semiconductor devices have an inherent chance of failure. You must protect against injury, damage or loss from such failures by incorporating safety design measures into your facility and equipment such as redundancy, fire protection, and prevention of over-current levels and other abnormal operating conditions.

If any products described in this document represent goods or technologies subject to certain restrictions on export under the Foreign Exchange and Foreign Trade Law of Japan, the prior authorization by Japanese government will be required for export of those products from Japan.

The company names and brand names herein are the trademarks or registered trademarks of their respective owners.

Edited Business Promotion Dept.