

**SINGLE OPERATIONAL AMPLIFIERS**

The LM741 series are general purpose operational amplifiers which feature improved performance over industry standards like the LM709. It is intended for a wide range of analog applications. The high gain and wide range of operating voltage provide superior performance in integrator, summing amplifier, and general feedback applications.

**FEATURES**

- Short circuit protection
- Excellent temperature stability
- Internal frequency compensation
- High Input voltage range
- Null of offset

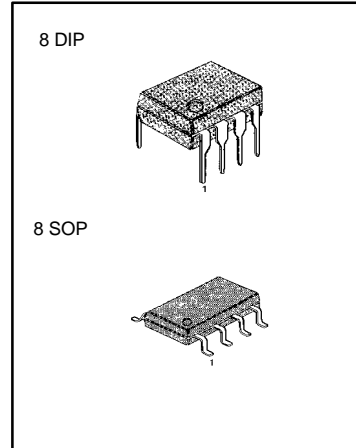

**BLOCK DIAGRAM**

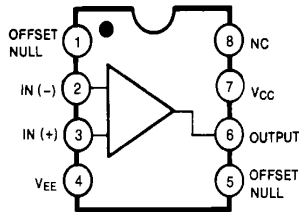

**ORDERING INFORMATION**

Device	Package	Operating Temperature
LM741N LM741EN	8 DIP	0 ~ +70°C
LM741M LM741EM	8 SOP	
LM741IN LM741EIN	8 DIP	-40 ~ +85 °C
LM741IM LM741EIM	8 SOP	

**SCHEMATIC DIAGRAM**

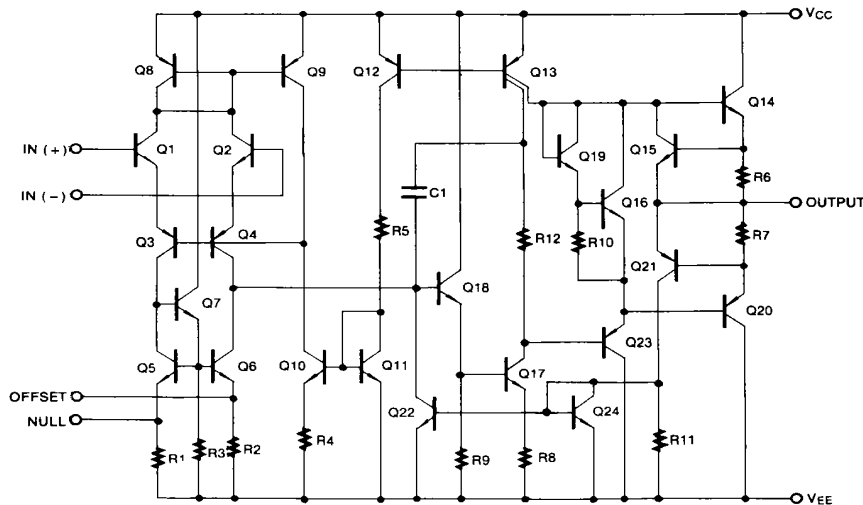

ABSOLUTE MAXIMUM RATINGS ( $T_A=25^\circ\text{C}$ )

Characteristic	Symbol	LM741	LM741E	LM741I	Unit
Supply Voltage	$V_{CC}$	$\pm 18$	$\pm 22$	$\pm 18$	V
Differential Input Voltage	$V_{I(DIFF)}$	30	30	30	V
Input Voltage	$V_I$	$\pm 15$	$\pm 15$	$\pm 15$	V
Output Short Circuit Duration		Indefinite	Indefinite	Indefinite	
Power Dissipation	$P_D$	500	500	500	mW
Operating Temperature Range	$T_{OPR}$	0 ~ + 70	0 ~ + 70	-40 ~ + 85	$^\circ\text{C}$
Storage Temperature Range	$T_{STG}$	-65 ~ + 150	-65 ~ + 150	-65 ~ + 150	$^\circ\text{C}$

## ELECTRICAL CHARACTERISTICS

( $V_{CC} = 15\text{V}$ ,  $V_{EE} = -15\text{V}$ ,  $T_A = 25^\circ\text{C}$ , unless otherwise specified)

Characteristic	Symbol	Test Conditions	LM741E			LM741/LM741I			Unit
			Min	Typ	Max	Min	Typ	Max	
Input Offset Voltage	$V_{IO}$	$R_S \leq 10\text{K}\Omega$					2.0	6.0	mV
		$R_S \leq 50\Omega$		0.8	3.0				
Input Offset Voltage Adjustment Range	$V_{IO(R)}$	$V_{CC} = \pm 20\text{V}$	$\pm 10$				$\pm 15$		mV
Input Offset Current	$I_{IO}$			3.0	30		20	200	nA
Input Bias Current	$I_{BIAS}$			30	80		80	500	nA
Input Resistance	$R_I$	$V_{CC} = \pm 20\text{V}$	1.0	6.0		0.3	2.0		M $\Omega$
Input Voltage Range	$V_{I(R)}$		$\pm 12$	$\pm 13$		$\pm 12$	$\pm 13$		V
Large Signal Voltage Gain	$G_V$	$R_L \geq 2\text{K}\Omega$	$V_{CC} = \pm 20\text{V}$ , $V_{O(P,P)} = \pm 15\text{V}$	50					V/mV
			$V_{CC} = \pm 15\text{V}$ , $V_{O(P,P)} = \pm 10\text{V}$				20	200	
Output Short Circuit Current	$I_{SC}$		10	25	35		25		mA
Output Voltage Swing	$V_{O(P,P)}$	$V_{CC} = \pm 20\text{V}$	$R_L \geq 10\text{K}\Omega$	$\pm 16$					V
			$R_L \geq 10\text{K}\Omega$	$\pm 15$					
		$V_{CC} = \pm 15\text{V}$	$R_L \geq 10\text{K}\Omega$				$\pm 12$	$\pm 14$	
			$R_L \geq 10\text{K}\Omega$				$\pm 10$	$\pm 13$	
Common Mode Rejection Ratio	CMRR	$R_S \leq 10\text{K}\Omega$ , $V_{CM} = \pm 12\text{V}$				70	90	dB	
		$R_S \leq 50\text{K}\Omega$ , $V_{CM} = \pm 12\text{V}$	80	95					
Power Supply Rejection Ratio	PSRR	$V_{CC} = \pm 15\text{V}$ to $V_{CC} = \pm 15\text{V}$ $R_S \leq 50\Omega$	86	96				dB	
		$V_{CC} = \pm 15\text{V}$ to $V_{CC} = \pm 15\text{V}$ $R_S \leq 10\text{K}\Omega$				77	96		

## ELECTRICAL CHARACTERISTICS (Continued)

Characteristic	Symbol	Test Conditions	LM741E			LM741/LM741I			Unit
			Min	Typ	Max	Min	Typ	Max	
Transient Response	Rise Time	$t_R$	Unity Gain						$\mu s$
	Overshoot	OS		0.25	0.8		0.3		%
Bandwidth	BW		0.43	1.5				MHz	
Slew Rate	SR	Unity Gain	0.3	0.7		0.5		V/ $\mu s$	
Supply Current	$I_{CC}$	$R_L = \infty \Omega$				1.5	2.8	mA	
Power Consumption	$P_C$	$V_{CC} = \pm 20V$		80	150			mW	
		$V_{CC} = \pm 15V$				50	85		

## ELECTRICAL CHARACTERISTICS

( $-40^\circ C \leq T_A \leq 85^\circ C$  for the KA741I  $^\circ C \leq T_A \leq 70^\circ C$  for the LM741 and LM741E.  $V_{CC} = \pm 15V$ , unless otherwise specified)

Characteristic	Symbol	Test Conditions	LM741E			LM741/LM741I			Unit
			Min	Typ	Max	Min	Typ	Max	
Input Offset Voltage	$V_{IO}$	$R_S \leq 50\Omega$			4.0				mV
		$R_S \leq 10K\Omega$					7.5		
Input Offset Voltage Drift	$\Delta V_{IO}/\Delta T$			15				$\mu V/^\circ C$	
Input Offset Current	$I_{IO}$				70		300	nA	
Input Offset Current Drift	$\Delta I_{IO}/\Delta T$				0.5			nA/ $^\circ C$	
Input Bias Current	$I_{BIAS}$				0.21		0.8	$\mu A$	
Input Resistance	$R_I$	$V_{CC} = \pm 20V$	0.5					M $\Omega$	
Input Voltage Range	$V_{I(R)}$		$\pm 12$	$\pm 13$		$\pm 12$	$\pm 13$	V	
Output Voltage Swing	$V_{O(P,P)}$	$V_{CC} = \pm 20V$	$R_S \geq 10K\Omega$	$\pm 16$					V
			$R_S \geq 2K\Omega$	$\pm 15$					
		$V_{CC} = \pm 15V$	$R_S \geq 10K\Omega$			$\pm 12$	$\pm 14$		
			$R_S \geq 2K\Omega$			$\pm 10$	$\pm 13$		
Output Short Circuit Current	$I_{SC}$		10	40	10	40	mA		
Common Mode Rejection Ratio	CMRR	$R_S \leq 10K\Omega, V_{CM} = \pm 12V$				70	90	dB	
		$R_S \leq 50K\Omega, V_{CM} = \pm 12V$	80	95					
Power Supply Rejection Ratio	PSRR	$V_{CC} = \pm 20V$ to $\pm 5V$	$R_S \leq 50\Omega$	86	96			dB	
			$R_S \leq 10K\Omega$			77	96		
Large Signal Voltage Gain	$G_V$	$R_S \geq 2K\Omega$	$V_{CC} = \pm 20V,$ $V_{O(P,P)} = \pm 15V$	32				V/mV	
			$V_{CC} = \pm 15V,$ $V_{O(P,P)} = \pm 10V$			15			
			$V_{CC} = \pm 15V,$ $V_{O(P,P)} = \pm 2V$	10					

TYPICAL PERFORMANCE CHARACTERISTICS

Fig. 7 OUTPUT RESISTANCE vs FREQUENCY

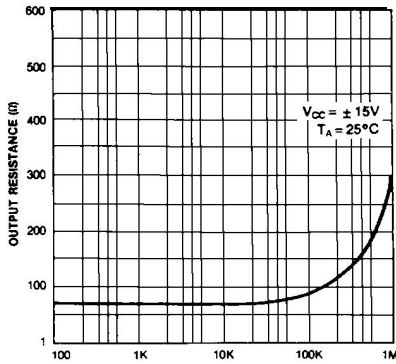

Fig. 8 INPUT RESISTANCE AND INPUT CAPACITANCE vs FREQUENCY

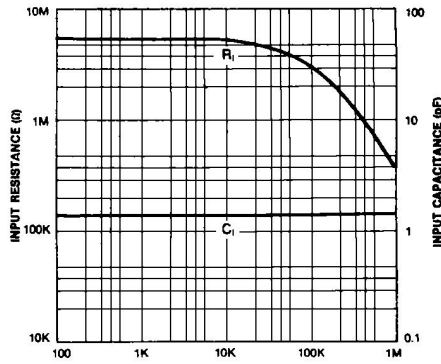

Fig. 9 INPUT BIAS CURRENT vs AMBIENT TEMPERATURE

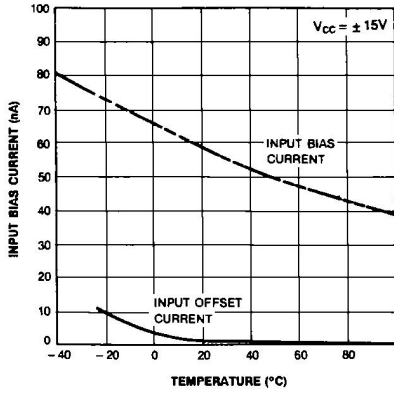

Fig. 10 POWER CONSUMPTION vs AMBIENT TEMPERATURE

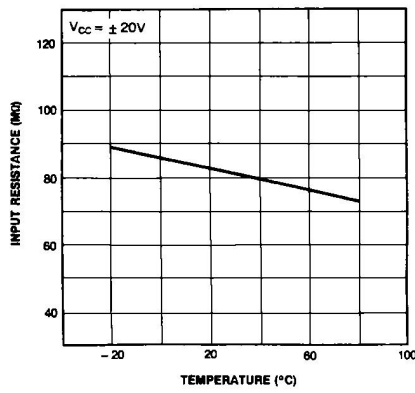

Fig. 11 INPUT OFFSET CURRENT vs AMBIENT TEMPERATURE

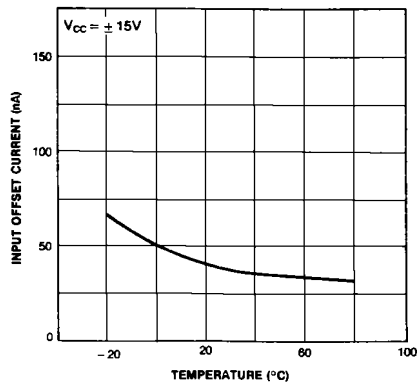

Fig. 12 INPUT RESISTANCE vs AMBIENT TEMPERATURE

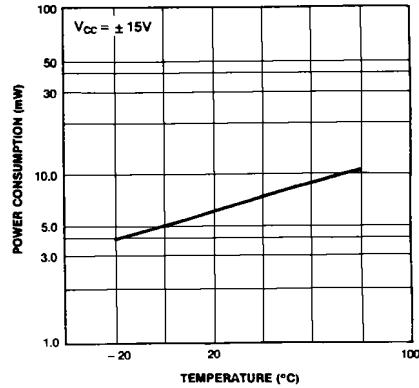

Fig. 13 NORMALIZED DC PARAMETERS vs AMBIENT TEMPERATURE

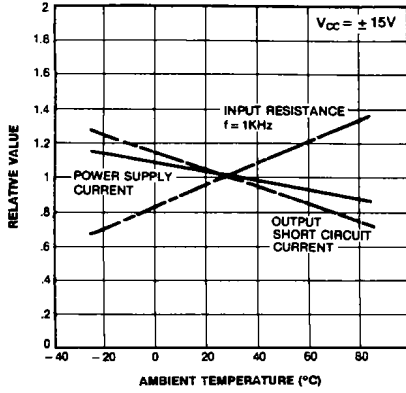

Fig. 14 FREQUENCY CHARACTERISTICS vs AMBIENT TEMPERATURE

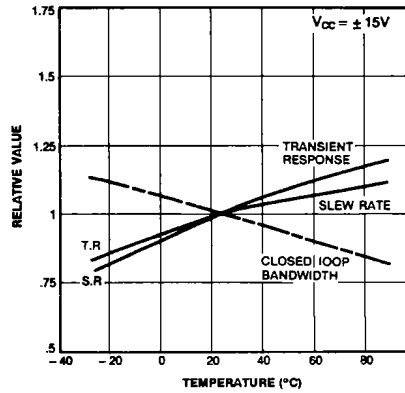

Fig. 15 FREQUENCY CHARACTERISTICS vs SUPPLY VOLTAGE

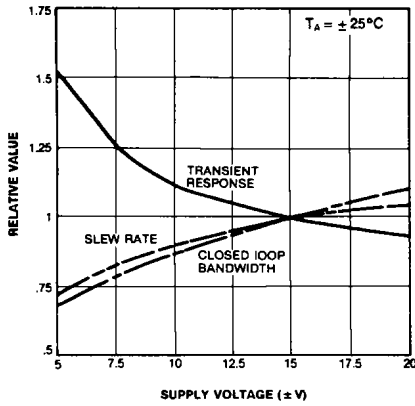

Fig. 16 OUTPUT SHORT CIRCUIT CURRENT vs AMBIENT TEMPERATURE

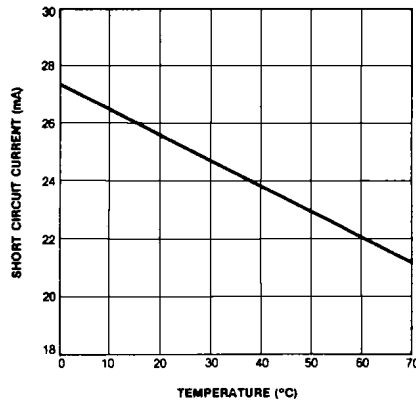

Fig. 17 TRANSIENT RESPONSE

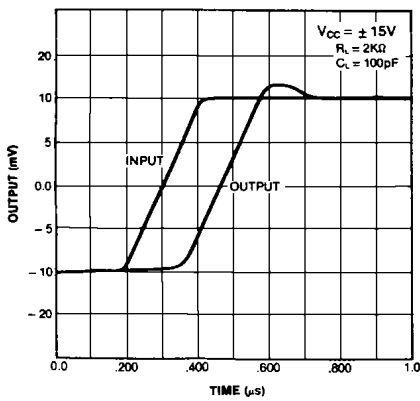

Fig. 18 COMMON-MODE REJECTION RATIO vs FREQUENCY

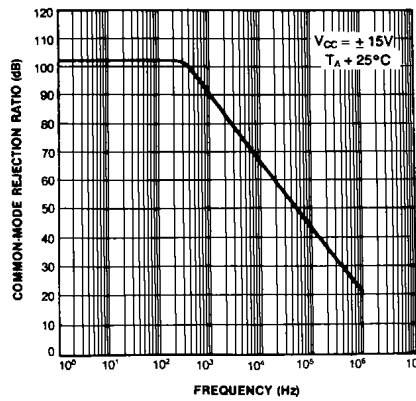

Fig. 18 VOLTAGE FOLLOWER LARGE SIGNAL PULSE RESPONSE

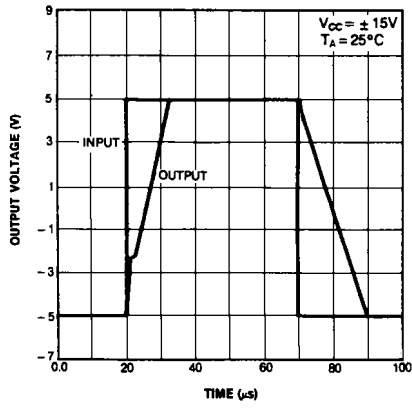
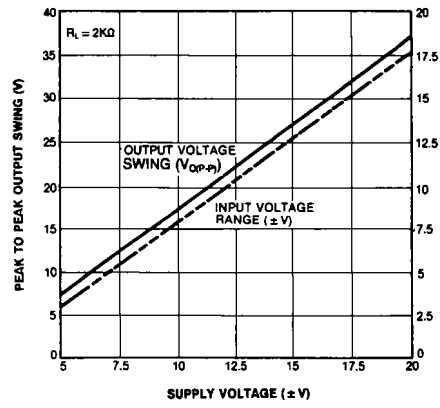

Fig. 19 OUTPUT SWING AND INPUT RANGE vs SUPPLY VOLTAGE



## TRADEMARKS

The following are registered and unregistered trademarks Fairchild Semiconductor owns or is authorized to use and is not intended to be an exhaustive list of all such trademarks.

ACEx™	ISOPLANAR™
CoolFET™	MICROWIRE™
CROSSVOLT™	POP™
E <sup>2</sup> CMOS™	PowerTrench™
FACT™	QS™
FACT Quiet Series™	Quiet Series™
FAST®	SuperSOT™-3
FASTr™	SuperSOT™-6
GTO™	SuperSOT™-8
HiSeC™	TinyLogic™

## DISCLAIMER

FAIRCHILD SEMICONDUCTOR RESERVES THE RIGHT TO MAKE CHANGES WITHOUT FURTHER NOTICE TO ANY PRODUCTS HEREIN TO IMPROVE RELIABILITY, FUNCTION OR DESIGN. FAIRCHILD DOES NOT ASSUME ANY LIABILITY ARISING OUT OF THE APPLICATION OR USE OF ANY PRODUCT OR CIRCUIT DESCRIBED HEREIN; NEITHER DOES IT CONVEY ANY LICENSE UNDER ITS PATENT RIGHTS, NOR THE RIGHTS OF OTHERS.

## LIFE SUPPORT POLICY

FAIRCHILD'S PRODUCTS ARE NOT AUTHORIZED FOR USE AS CRITICAL COMPONENTS IN LIFE SUPPORT DEVICES OR SYSTEMS WITHOUT THE EXPRESS WRITTEN APPROVAL OF FAIRCHILD SEMICONDUCTOR CORPORATION. As used herein:

1. Life support devices or systems are devices or systems which, (a) are intended for surgical implant into the body, or (b) support or sustain life, or (c) whose failure to perform when properly used in accordance with instructions for use provided in the labeling, can be reasonably expected to result in significant injury to the user.
2. A critical component is any component of a life support device or system whose failure to perform can be reasonably expected to cause the failure of the life support device or system, or to affect its safety or effectiveness.

## PRODUCT STATUS DEFINITIONS

### Definition of Terms

Datasheet Identification	Product Status	Definition
Advance Information	Formative or In Design	This datasheet contains the design specifications for product development. Specifications may change in any manner without notice.
Preliminary	First Production	This datasheet contains preliminary data, and supplementary data will be published at a later date. Fairchild Semiconductor reserves the right to make changes at any time without notice in order to improve design.
No Identification Needed	Full Production	This datasheet contains final specifications. Fairchild Semiconductor reserves the right to make changes at any time without notice in order to improve design.
Obsolete	Not In Production	This datasheet contains specifications on a product that has been discontinued by Fairchild semiconductor. The datasheet is printed for reference information only.