

Features

- Industry standard driver replacement
- Improved response times
- Matched rise and fall times
- Reduced clock skew
- Low output impedance
- Low input capacitance
- High noise immunity
- Improved clocking rate
- Low supply current
- Wide operating range
- Separate drain connections

Applications

- Clock/line drivers
- CCD Drivers
- Ultra-sound transducer drivers
- Power MOSFET drivers
- Switch mode power supplies
- Resonant charging
- Cascoded drivers

Ordering Information

Part No.	Temp. Range	Pkg.	Outline #
EL7104CN	-40°C to +85°C	8-Pin P-DIP	MDP0031
EL7104CS	-40°C to +85°C	8-Pin SOIC	MDP0027
EL7114CN	-40°C to +85°C	8-Pin P-DIP	MDP0031
EL7114CS	-40°C to +85°C	8-Pin SOIC	MDP0027

General Description

The EL7104C/EL7114C ICs are matched driver ICs that improve the operation of the industry standard TC-4420/29 clock drivers. The Elantec versions are very high speed drivers capable of delivering peak currents of 4A into highly capacitive loads. The high speed performance is achieved by means of a proprietary "Turbo-Driver" circuit that speeds up input stages by tapping the wider voltage swing at the output. Improved speed and drive capability are enhanced by matched rise and fall delay times. These matched delays maintain the integrity of input-to-output pulse-widths to reduce timing errors and clock skew problems. This improved performance is accompanied by a 10 fold reduction in supply currents over bipolar drivers, yet without the delay time problems commonly associated with CMOS devices.

Connection Diagrams

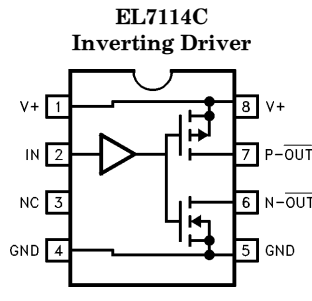
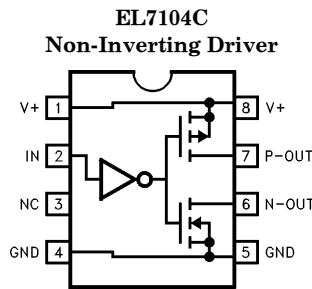

Manufactured under U.S. Patent Nos. 5,334,883, # 5,341,047

Note: All information contained in this data sheet has been carefully checked and is believed to be accurate as of the date of publication; however, this data sheet cannot be a "controlled document". Current revisions, if any, to these specifications are maintained at the factory and are available upon your request. We recommend checking the revision level before finalization of your design documentation.

EL7104C/EL7114C

High Speed, Single Channel, Power MOSFET Drivers

Absolute Maximum Ratings

Supply (V+ to Gnd)	16.5V	Operating Junction Temperature	125°C
Input Pins	-0.3V to +0.3V above V+	Power Dissipation	
Peak Output Current	4A	SOIC	570 mW
Storage Temperature Range	-65°C to +150°C	PDIP	1050 mW
Ambient Operating Temperature	-40°C to +85°C		

Important Note:

All parameters having Min/Max specifications are guaranteed. The Test Level column indicates the specific device testing actually performed during production and Quality inspection. Elantec performs most electrical tests using modern high-speed automatic test equipment, specifically the LTX77 Series system. Unless otherwise noted, all tests are pulsed tests, therefore $T_J = T_C = T_A$.

Test Level	Test Procedure
I	100% production tested and QA sample tested per QA test plan QCX0002.
II	100% production tested at $T_A = 25^\circ\text{C}$ and QA sample tested at $T_A = 25^\circ\text{C}$, T_{MAX} and T_{MIN} per QA test plan QCX0002.
III	QA sample tested per QA test plan QCX0002.
IV	Parameter is guaranteed (but not tested) by Design and Characterization Data.
V	Parameter is typical value at $T_A = 25^\circ\text{C}$ for information purposes only.

DC Electrical Characteristics $T_A = 25^\circ\text{C}$, $V_+ = 15\text{V}$ unless otherwise specified

Parameter	Description	Test Conditions	Min	Typ	Max	Test Level	Units
Input							
V_{IH}	Logic "1" Input Voltage		2.4			I	V
I_{IH}	Logic "1" Input Current	@V+		0.1	10	I	μA
V_{IL}	Logic "0" Input Voltage				0.8	I	V
I_{IL}	Logic "0" Input Current	@0V		0.1	10	I	μA
V_{HVS}	Input Hysteresis			0.3		V	V
Output							
R_{OH}	Pull-Up Resistance	$I_{OUT} = -100\text{ mA}$		1.5	4	I	Ω
R_{OL}	Pull-Down Resistance	$I_{OUT} = +100\text{ mA}$		2	4	I	Ω
I_{OUT}	Output Current	V+ /GND		0.2	10	I	μA
I_{PK}	Peak Output Current	Source Sink		4 4		IV	A
I_{DC}	Continuous Output Current	Source/Sink	200			I	mA
Power Supply							
I_S	Power Supply Current	Input = V+ EL7104 EL7114		4.5 1	7.5 2.5	I	mA
V_S	Operating Voltage		4.5		16	I	V

EL7104C/EL7114C

High Speed, Single Channel, Power MOSFET Drivers

AC Electrical Characteristics $T_A = 25^\circ\text{C}$, $V = 15\text{V}$ unless otherwise specified

Parameter	Description	Test Conditions	Min	Typ	Max	Test Level	Units
Switching Characteristics							
t_R	Rise Time	$C_L = 1000\text{ pF}$ $C_L = 2000\text{ pF}$		7.5 10	20	IV	ns
t_F	Fall Time	$C_L = 1000\text{ pF}$ $C_L = 2000\text{ pF}$		10 15	20	IV	ns
t_{D-ON}	Turn-On Delay Time	See Timing Table		18	25	IV	ns
t_{D-OFF}	Turn-Off Delay Time	See Timing Table		18	25	IV	ns

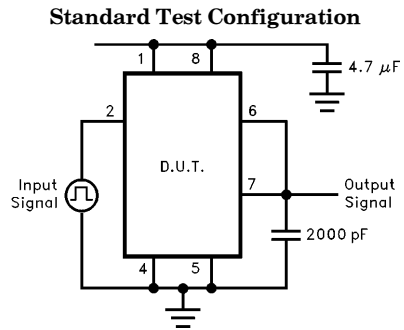
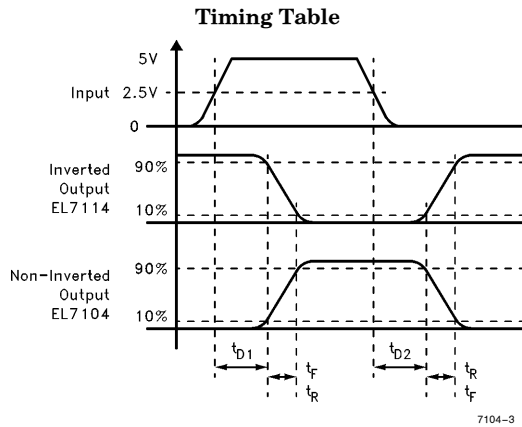

EL7104C/EL7114C

High Speed, Single Channel, Power MOSFET Drivers

7104C Simplified Schematic

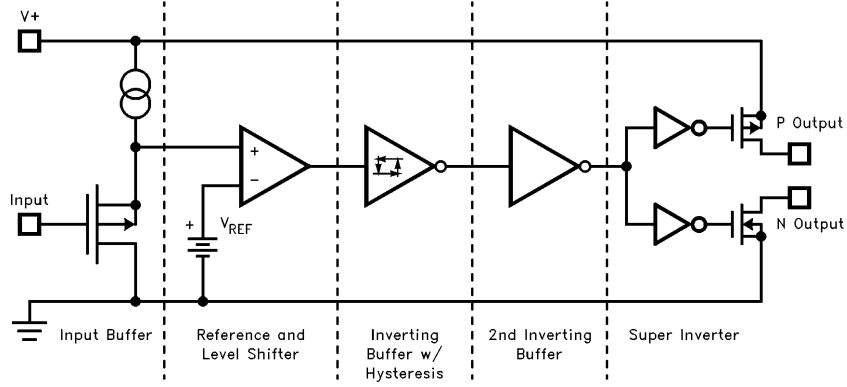

7104-5

7114C Simplified Schematic

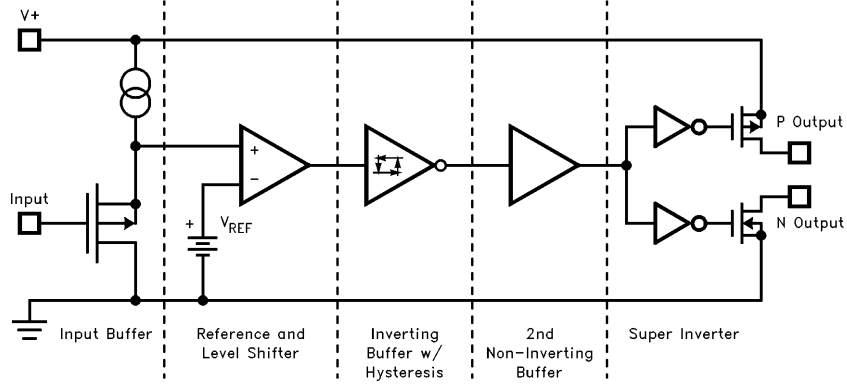

7104-6

EL7104C/EL7114C

High Speed, Single Channel, Power MOSFET Drivers

Typical Performance Curve

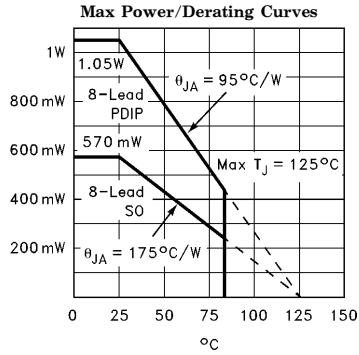

7104-7

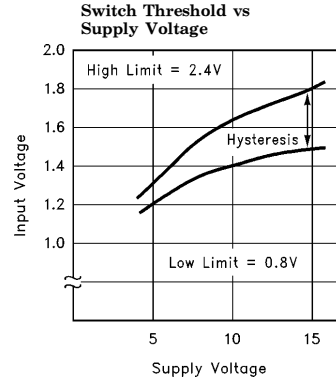

7104-8

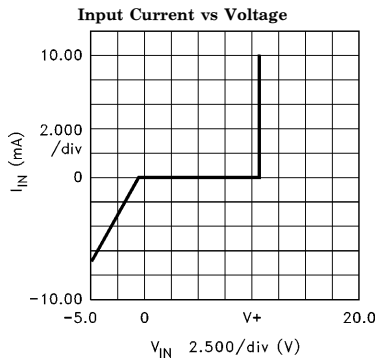

7104-9

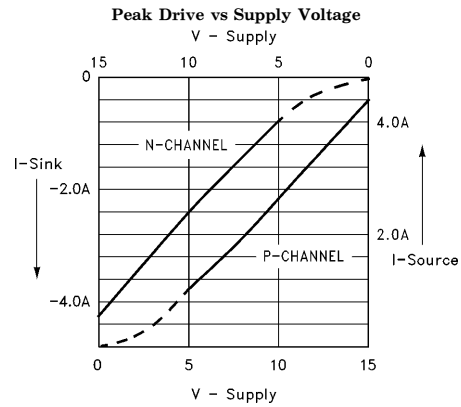

7104-10

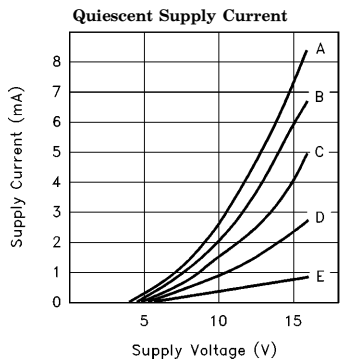

CASE:

Device	Input Level	Curve
EL7104	GND	A
EL7104	V+	C
EL7114	GND	C
EL7114	V+	E

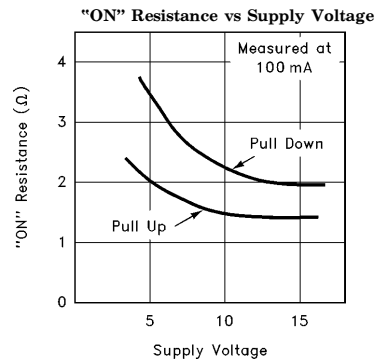

7104-11

7104-12

EL7104C/EL7114C

High Speed, Single Channel, Power MOSFET Drivers

Typical Performance Curve — Contd.

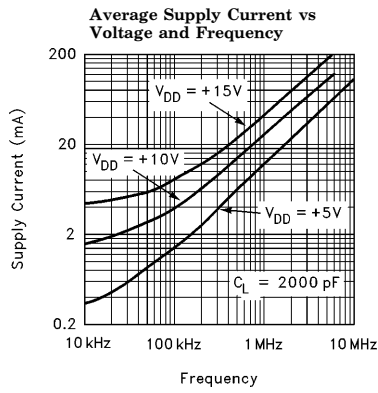

7104-13

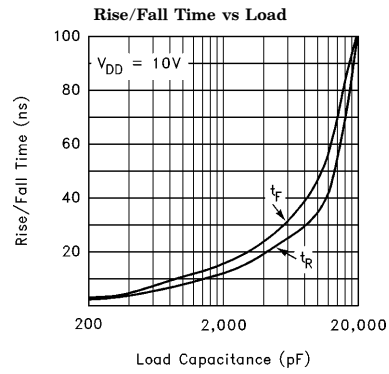

7104-15

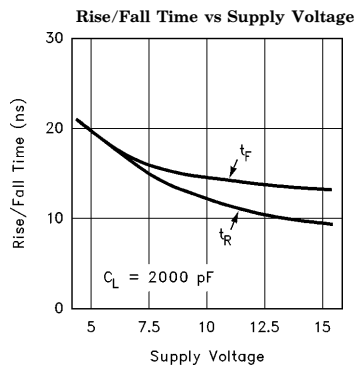

7104-16

EL7104C/EL7114C

High Speed, Single Channel, Power MOSFET Drivers

Typical Performance Curve — Contd.

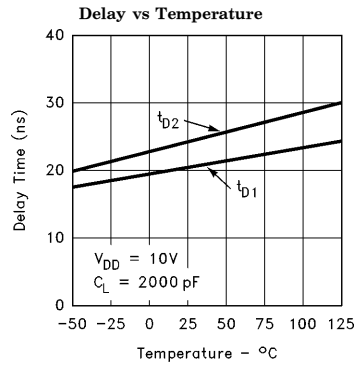
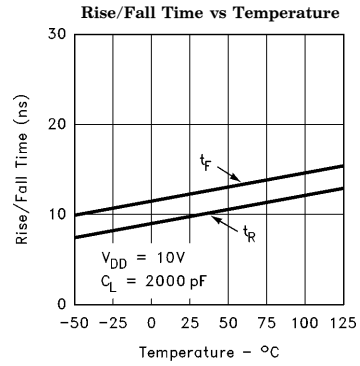
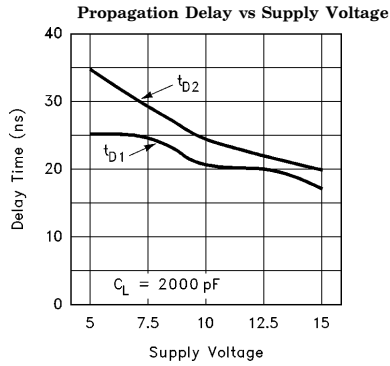

EL7104C/EL7114C

High Speed, Single Channel, Power MOSFET Drivers

General Disclaimer

Specifications contained in this data sheet are in effect as of the publication date shown. Elantec, Inc. reserves the right to make changes in the circuitry or specifications contained herein at any time without notice. Elantec, Inc. assumes no responsibility for the use of any circuits described herein and makes no representations that they are free from patent infringement.

élantec
HIGH PERFORMANCE ANALOG INTEGRATED CIRCUITS

Elantec, Inc.
1996 Tarob Court
Milpitas, CA 95035
Telephone: (408) 945-1323
(800) 333-6314
Fax: (408) 945-9305
European Office: 44-71-482-4596

WARNING — Life Support Policy

Elantec, Inc. products are not authorized for and should not be used within Life Support Systems without the specific written consent of Elantec, Inc. Life Support systems are equipment intended to support or sustain life and whose failure to perform when properly used in accordance with instructions provided can be reasonably expected to result in significant personal injury or death. Users contemplating application of Elantec, Inc. products in Life Support Systems are requested to contact Elantec, Inc. factory headquarters to establish suitable terms & conditions for these applications. Elantec, Inc.'s warranty is limited to replacement of defective components and does not cover injury to persons or property or other consequential damages.