

### PRELIMINARY SPEC



**ATTENTION**  
OBSERVE PRECAUTIONS  
FOR HANDLING  
ELECTROSTATIC  
DISCHARGE  
SENSITIVE  
DEVICES

Part Number: APFA3010SURKCGKPBAC

Hyper Red  
Green  
Blue

### Features

- 3.0mmx1.0mm RIGHT ANGLE SMT LED, 1.5mm THICKNESS.
- LOW POWER CONSUMPTION.
- WIDE VIEWING ANGLE.
- IDEAL FOR BACKLIGHT AND INDICATOR.
- PACKAGE : 2000PCS / REEL.
- MOISTURE SENSITIVITY LEVEL : LEVEL 3.
- RoHS COMPLIANT.

### Description

The Hyper Red source color devices are made with InGaAlP on GaAs substrate Light Emitting Diode.  
The Green source color devices are made with InGaAlP on GaAs substrate Light Emitting Diode.  
The Blue source color devices are made with InGaN on SiC Light Emitting Diode.  
Static electricity and surge damage the LEDs.  
It is recommended to use a wrist band or anti-electrostatic glove when handling the LEDs.  
All devices, equipment and machinery must be electrically grounded.

### Package Dimensions

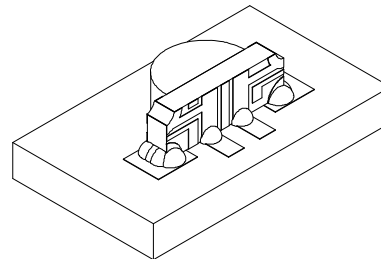
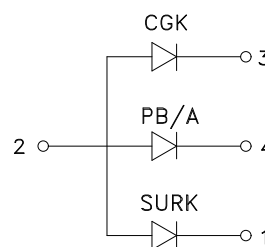
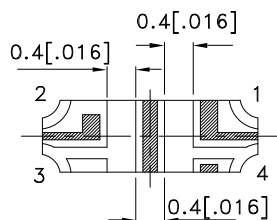
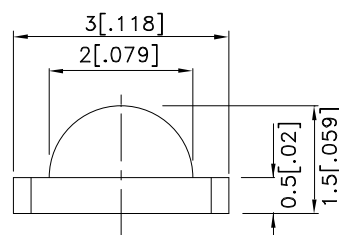
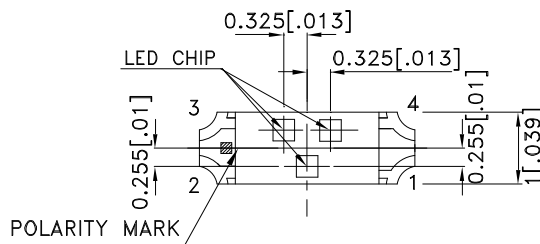

#### Notes:

1. All dimensions are in millimeters (inches).
2. Tolerance is  $\pm 0.2(0.008)$  unless otherwise noted.
3. Specifications are subject to change without notice.
4. The device has a single mounting surface. The device must be mounted according to the specifications.



## Selection Guide

Part No.	Dice	Lens Type	Iv (mcd) [2] @ 20mA		Viewing Angle [1]
			Min.	Typ.	2θ1/2
APFA3010SURKCGKPAC	Hyper Red (InGaAlP)	WATER CLEAR	70	200	120°
	Green (InGaAlP)		18	50	
	Blue (InGaN)		18	60	

Notes:

1. θ1/2 is the angle from optical centerline where the luminous intensity is 1/2 the optical centerline value.
2. Luminous intensity/ Luminous Flux: +/-15%.

## Electrical / Optical Characteristics at TA=25°C

Symbol	Parameter	Device	Typ.	Max.	Units	Test Conditions
λ <sub>peak</sub>	Peak Wavelength	Hyper Red Green Blue	650 574 468		nm	I <sub>F</sub> =20mA
λ <sub>D</sub> [1]	Dominant Wavelength	Hyper Red Green Blue	635 570 470		nm	I <sub>F</sub> =20mA
Δλ <sub>1/2</sub>	Spectral Line Half-width	Hyper Red Green Blue	28 20 21		nm	I <sub>F</sub> =20mA
C	Capacitance	Hyper Red Green Blue	35 15 100		pF	V <sub>F</sub> =0V;f=1MHz
V <sub>F</sub> [2]	Forward Voltage	Hyper Red Green Blue	1.95 2.1 3.2	2.5 2.5 4	V	I <sub>F</sub> =20mA
I <sub>R</sub>	Reverse Current	Hyper Red Green Blue		10 10 10	μA	V <sub>R</sub> =5V

Notes:

1. Wavelength: +/-1nm.
2. Forward Voltage: +/-0.1V.

## Absolute Maximum Ratings at TA=25°C

Parameter	Hyper Red	Green	Blue	Units
Power dissipation	75	75	120	mW
DC Forward Current	30	30	30	mA
Peak Forward Current [1]	185	150	100	mA
Reverse Voltage	5			V
Operating Temperature	-40°C To +85°C			
Storage Temperature	-40°C To +85°C			

Notes:

1. 1/10 Duty Cycle, 0.1ms Pulse Width.

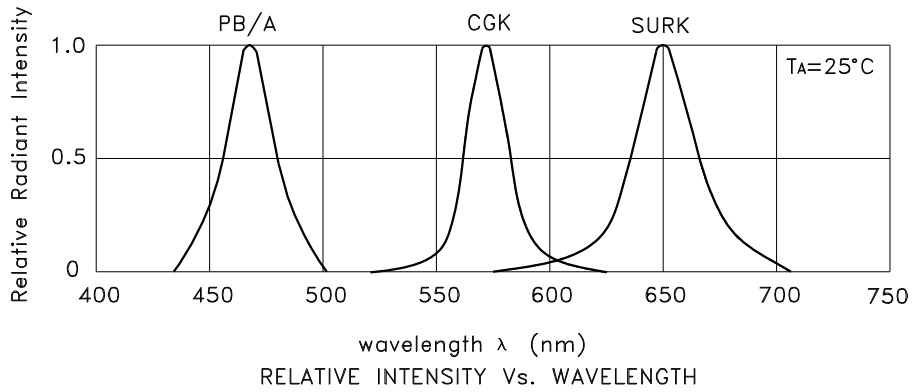

## APFA3010SURKCGKPBAC Hyper Red

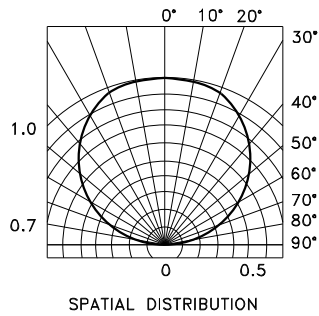
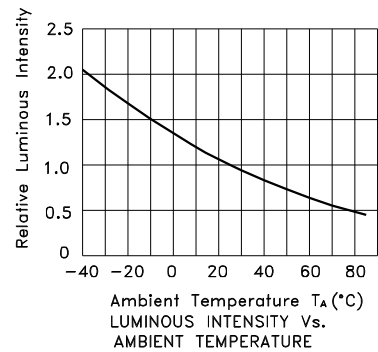
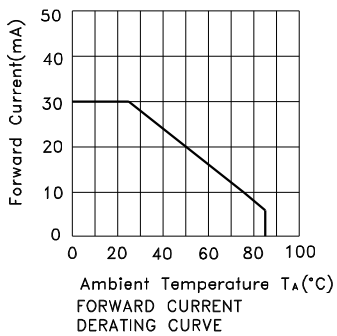
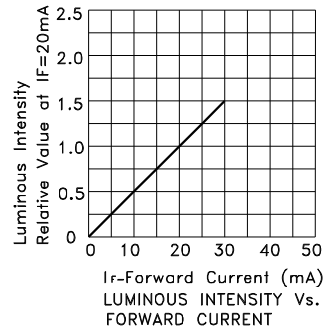
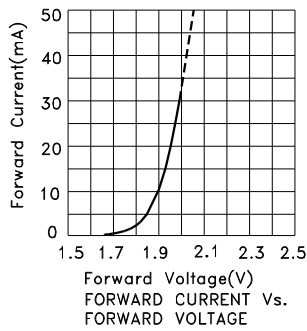

# Kingbright

## Green

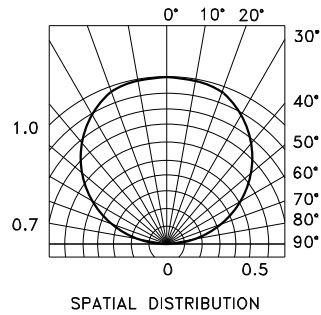
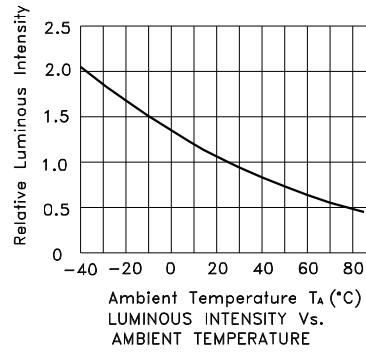
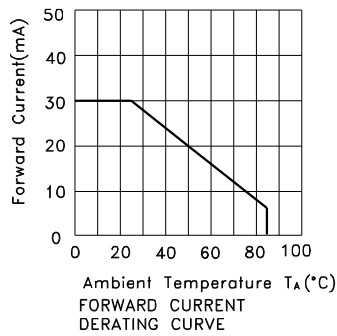
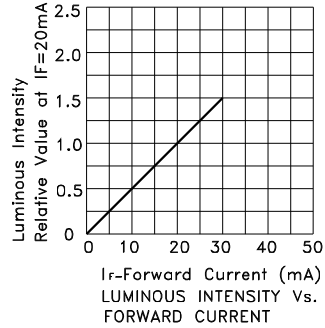
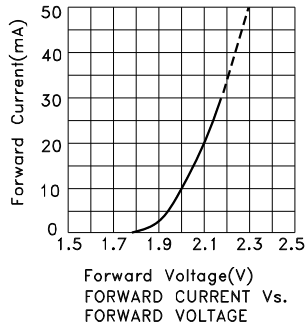

# Kingbright

## Blue

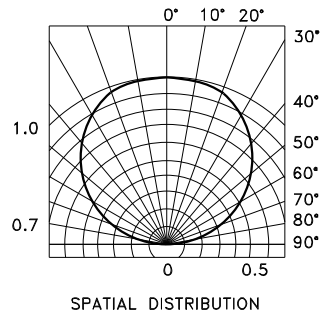
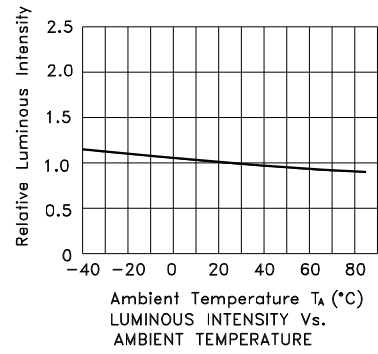
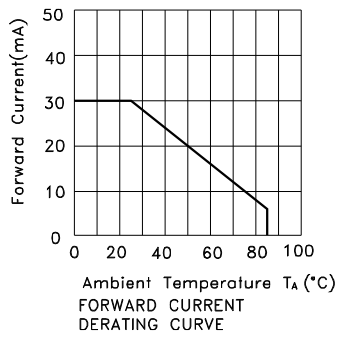
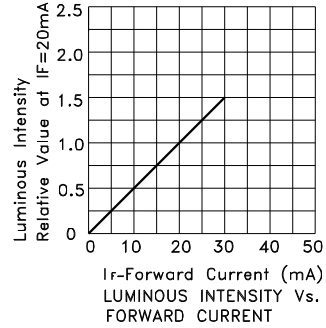
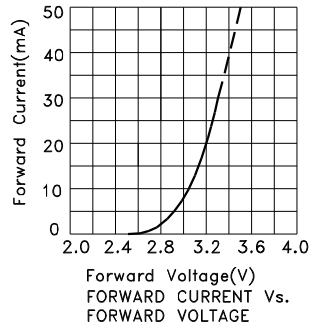

## APFA3010SURKCGKPBAC

Reflow Soldering Profile For Lead-free SMT Process.

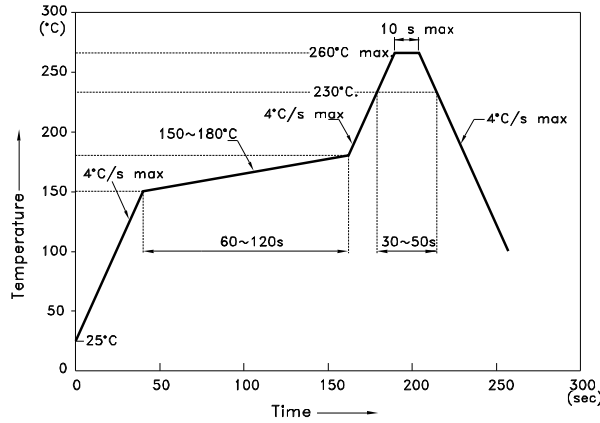

**NOTES:**

1. We recommend the reflow temperature 245°C(+/-5°C). The maximum soldering temperature should be limited to 260°C.
2. Don't cause stress to the epoxy resin while it is exposed to high temperature.
3. Number of reflow process shall be 2 times or less.

**Recommended Soldering Pattern  
(Units : mm; Tolerance: ± 0.1)**

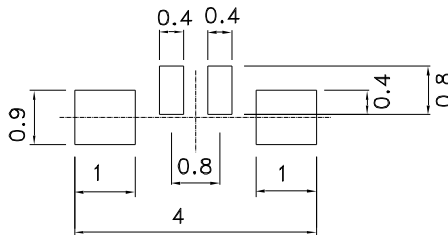

**Tape Specifications  
(Units : mm)**

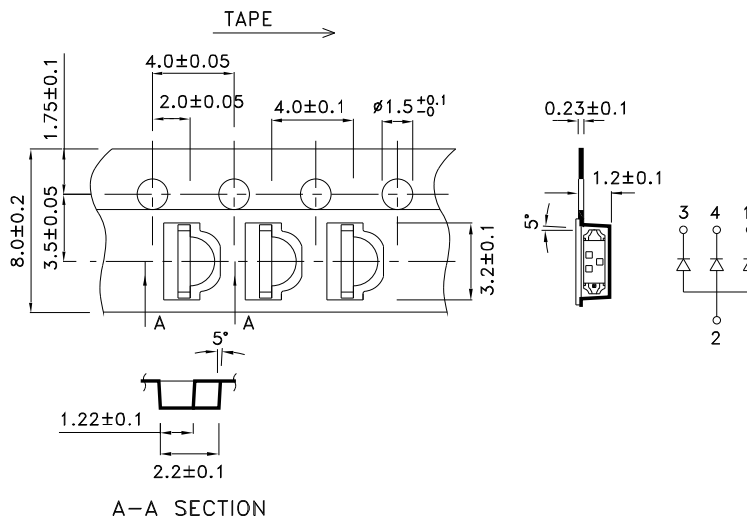

# Kingbright

## PACKING & LABEL SPECIFICATIONS

## APFA3010SURKCGKPBAC

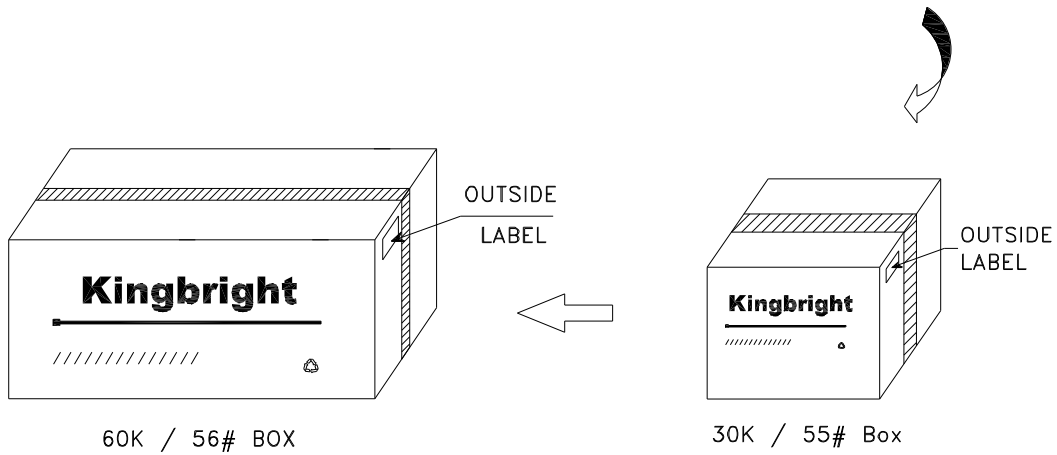
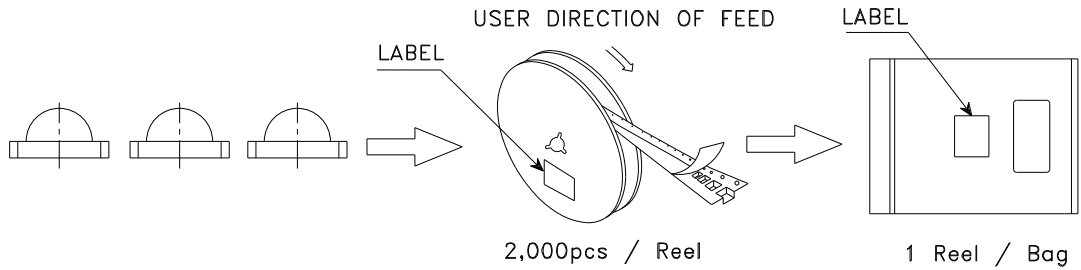

<h1>Kingbright</h1>	
P/NO: APFA3010xxx	
QTY: 2,000 pcs	Q.C. <span style="border: 1px solid black; border-radius: 50%; padding: 2px;">Q C xx xx xxxx PASSED</span>
S/N: XXXX	
CODE: XXX	
LOT NO:	
 xxxxxxxxxxxxxxxxxxxxxxxxxxxx	
RoHS Compliant	