

Type: S-4, S-4N
◆ Product Description

- 5.2×5.2mm Max.(L×W), 4.3mm Max. Height(S-4).
- 4.8×4.8mm Max.(L×W), 4.0mm Max. Height(S-4N).
- Inductance: 1.0μH Max.
- Operating frequency: 300MHz Max.
- In addition to the reference versions of parameters shown here, custom designs are available to meet your exact requirements.

◆ Feature

- Variable type.
- Both shielded(S-4) and unshielded(S-4N) types are available.
- RoHS Compliance

◆ Dimensions (mm)

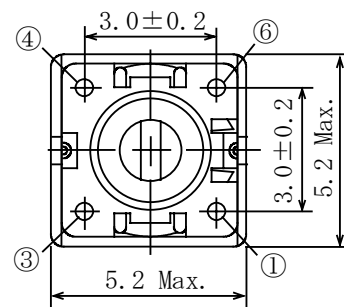
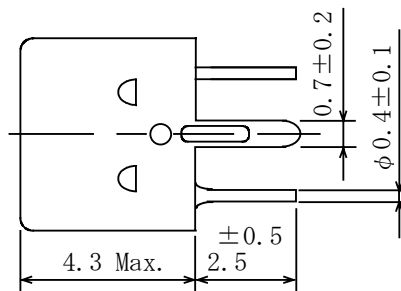
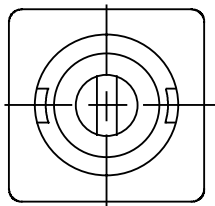
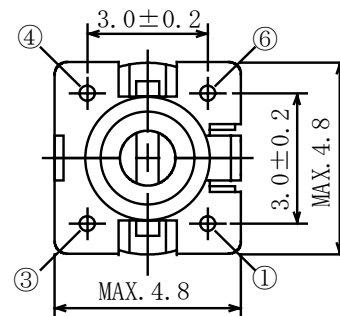
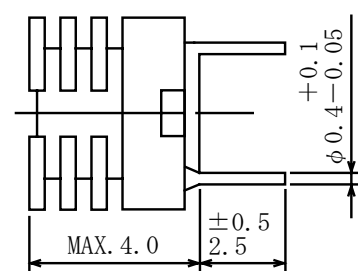
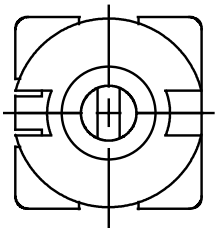
S-4

S-4N

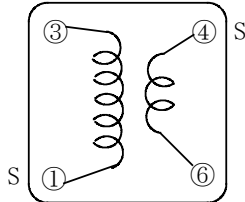
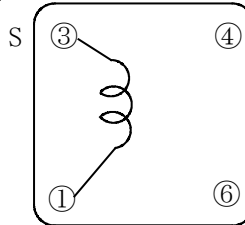
- * Dimension does not include solder used on coil.
- * Pin pitch should be measured at the root of terminal.
- * Dimensions without tolerance are approx.

Type: S-4, S-4N
◆ Connection (Bottom View)
S-4

S-4N

“S” is winding start.

◆ Specification (S-4) (Part No. 2250-T050)

Item	(1 – 3)	Measuring Condition
Tuning capacity	15.3 pF ± 1% Variable	60 MHz
Unloaded Qu	25 Min.	60 MHz

◆ Specification (S-4N) (Part No. 2230-T019)

Item	(1 – 3)	Measuring Condition
Tuning Capacity	5.8 pF ± 1% Variable	80 MHz
Unloaded Qu	Min. 30	80 MHz
Inductance	80 nH (Ref.)	98 MHz