

FPR / FPS 2-T220 4-T220 2-T221 4-T221



- Extremely Low-Ohm
- Small Dimensions
- High Stability
- Low Inductance
- Low Electrical Noise
- Low Temperature Coefficient
- TO220-Housing
- SMD available

SPECIFICATIONS

ELECTRICAL

Resistor Range	:	0R002 ... 50R
Power Rating	:	1.5 W (70°C) 15 W with heatsink
Thermal Resistance Rthj-c	:	4.8 K/W
Tolerances	:	
from 0R002	:	2%, 5% / 4-pin version also 1.0%
from 0R010	:	1%, 2%, 5% 4-pin version also 0.1% and 0.25%
from 0R100	:	0.5%, 1%, 2%, 5% 4-pin version also 0.1% and 0.25%
Stability	:	0.1%, 0.2%, 0.5% (depends on the stress)
Temperature Coefficient	:	±15 ppm/K (20...60)°C / ±50 ppm/K (-40...130)°C FPR 2-T220/221 R<0R2 TCR-Shift depends on resistor value (see table next page)
Max. Current	:	50 A
Insulation Resistance	:	300 VDC
Thermal EMF	:	< 1 µV/K

ENVIRONMENTAL

Operating Temperature	:	-40°C...130°C
------------------------------	---	---------------

MECHANICAL

Resistor Material	:	Metalfoil CuNiMn (DIN 17471)
Substrate	:	Al ₂ O ₃ or anodized aluminium
Housing	:	Epoxidharz or PPS
Connector Material	:	Cu tinned, 2-pin or 4-pin
Max. torque backplate	:	1 Nm / T221: 0.8 Nm

FPR / FPS

2-T220 4-T220 2-T221 4-T221



TEMPERATURE COEFFICIENT

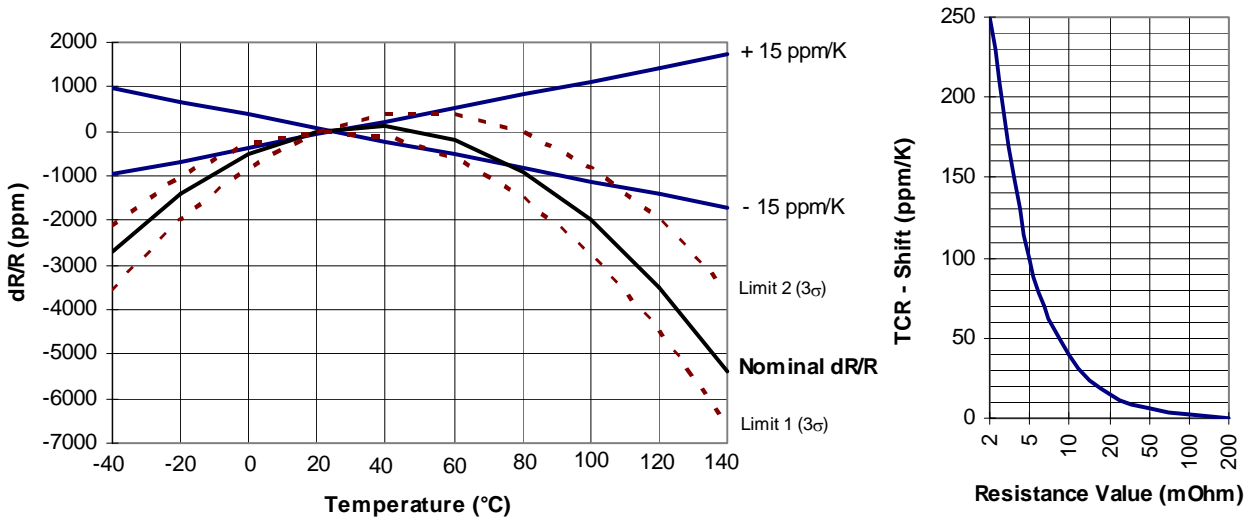

DERATING CURVE

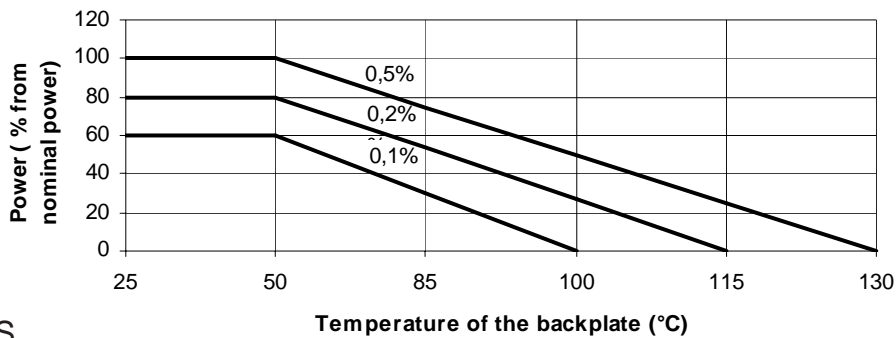

DIMENSIONS

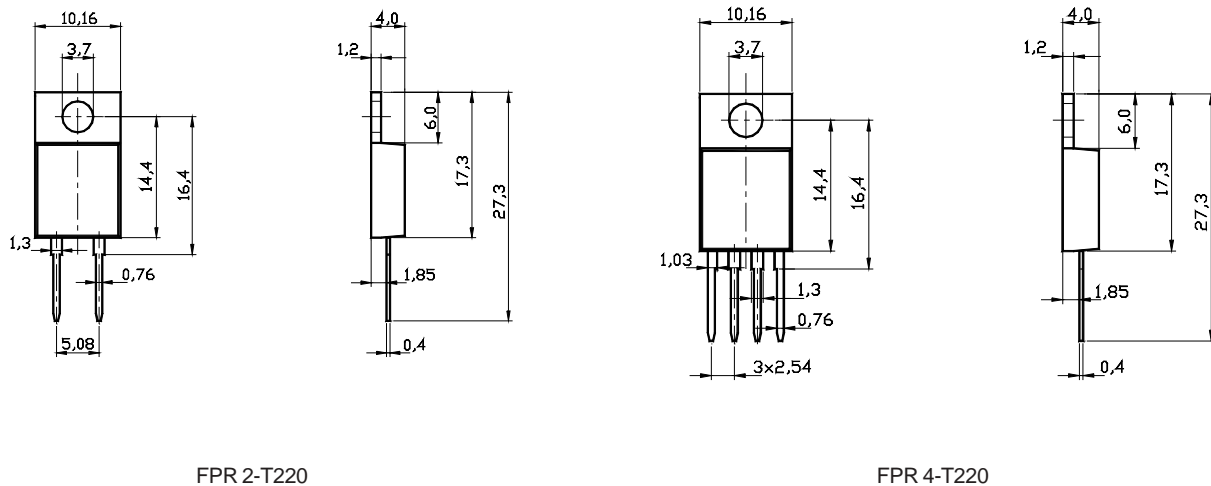

FPR / FPS

2-T220 4-T220 2-T221 4-T221



DIMENSIONS

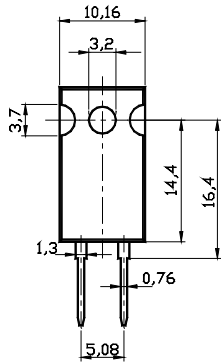

FPR 2-T221

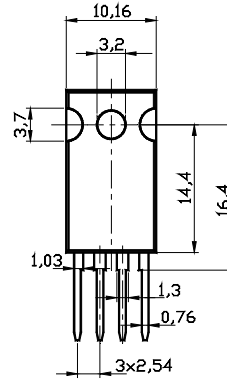
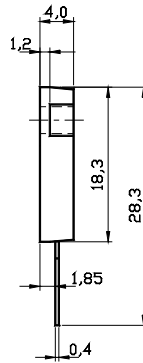

FPR 4-T221

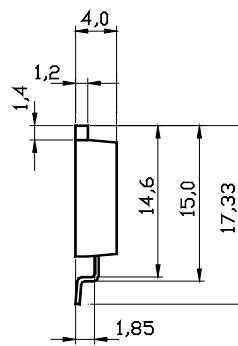
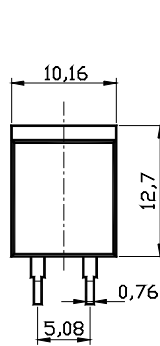
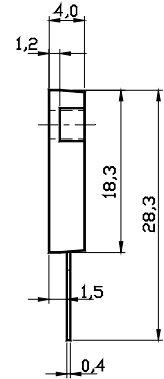

FPS 2-T220

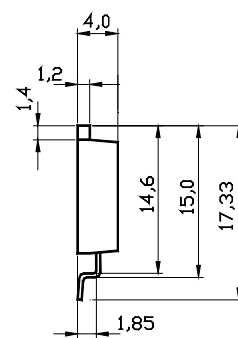
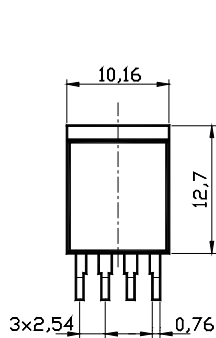
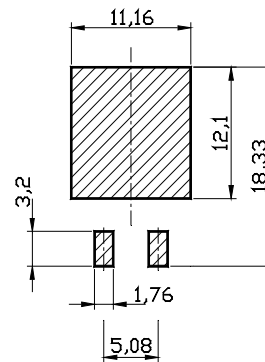

FPS 4-T220

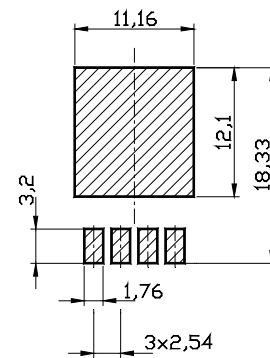

HOW TO ORDER

FPR 2-T220 10R 0.25%
FPR 2-T221 0R068 0.5%

FPS 2-T220 1R0 1%
FPR 4-T221 0R1 0.5%