

SMTT-800I



Thyristor-Thyristor Module



Type	V_{RSM}	V_{RRM} , V_{DRM}
SMTT-800I-08	900	800
SMTT-800I-12	1300	1200
SMTT-800I-14	1500	1400
SMTT-800I-16	1700	1600
SMTT-800I-18	1900	1800

Type	I_{TAVM}	I_{TRMS}	T_c	I_{TSM}	$(di/dt)_{cr}$	$(dv/dt)_{cr}$	V_{TM}	I_{TM}	V_{TO}	r_T	t_q	V_{GT}	I_{GT}	T_{VJM}	V_{isol}	R_{thJC}
	A	kA	°C	kA	A/μs	V/μs	V	A	V	mΩ	μs	V	mA	°C	V	K/W
SMTT-800I	800	1.25	85	30	100	1000	1.45	2000	0.9	0.21	350	3.0	350	125	3600	0.04

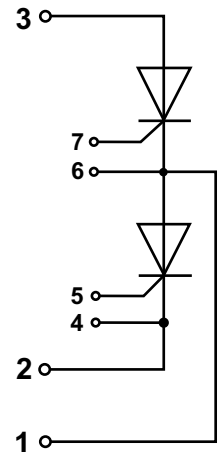
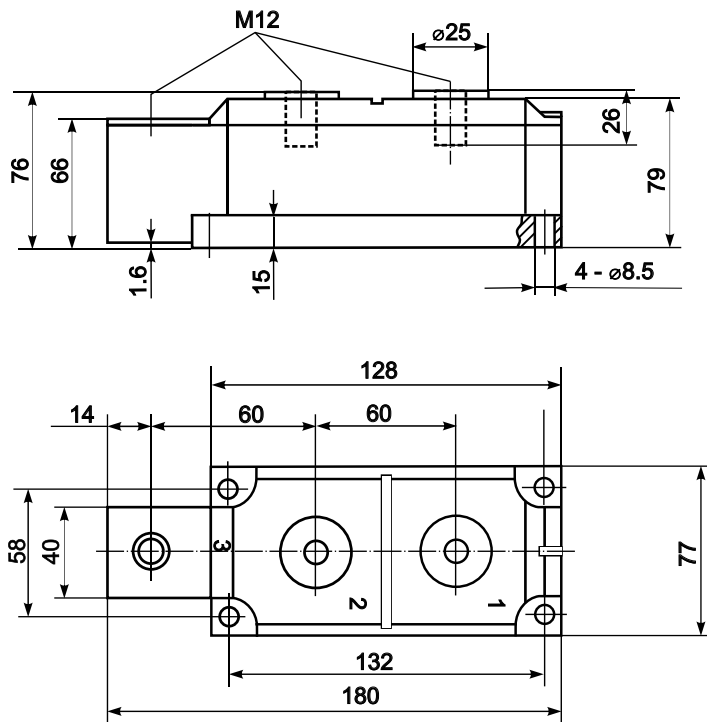

Features:

- Industrial standard package
- Heat transfer through aluminium nitride ceramic isolated metal baseplate
- Precise internal pressure contacts for high reliability
- 3600V RMS isolation voltage

Typical Applications:

- DC motor control
- AC motor soft starter
- Temperature control (e.g. for ovens, chemical processes)
- Lighting control