

SMTC1-600H



High Frequency Thyristor



Type	V_{RSM}	V_{RRM} , V_{DRM}
SMTC1-600H-8	900	800
SMTC1-600H-10	1100	1000
SMTC1-600H-12	1300	1200
SMTC1-600H-14	1500	1400
SMTC1-600H-16	1700	1600

Type	I_{TAVM} $T_c=55^\circ\text{C}$	I_{TSM}	$(di/dt)_{cr}$	$(dv/dt)_{cr}$	V_{TM}	I_{TM}	V_{TO}	r_T	V_{GT}	I_{GT}	T_{VJM}	R_{thJC}	F
	A	kA	A/ μs	V/ μs	V	kA	V	m Ω	V	mA	$^\circ\text{C}$	K/W	kN
SMTC1-600H	600	6.0	200	500-1000	2.7	2.0	1.20	0.40	3.0	250	115	0.032	25

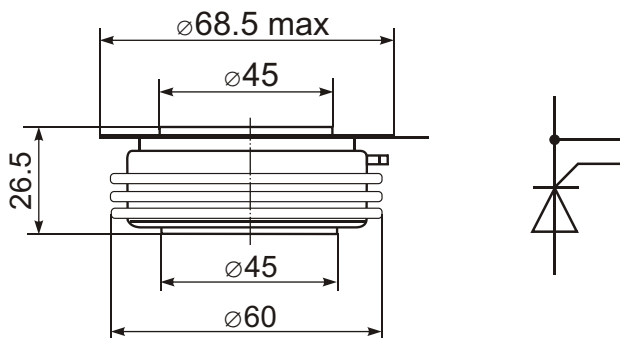
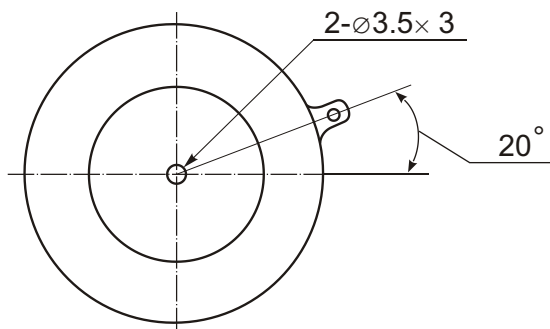

Type	$t_{g'}$ $(T_c=105^\circ\text{C})$	I_T/f
	μs	A/KHz
SMTC1-600H-xx-PGD7	12	300/10
SMTC1-600H-xx-OGD7	16	
SMTC1-600H-xx-NGD7	20	

Features:

- Hermetic metal case with ceramic insulator
- Capsule packages for double sided cooling
- High frequency performance (2.5-10 KHz)
- International standard case
- Low consumption switch

Typical Applications:

- Inverter
- Welding machine
- Inductive heating
- Uninterruptable power supplies