

SMDCx-800

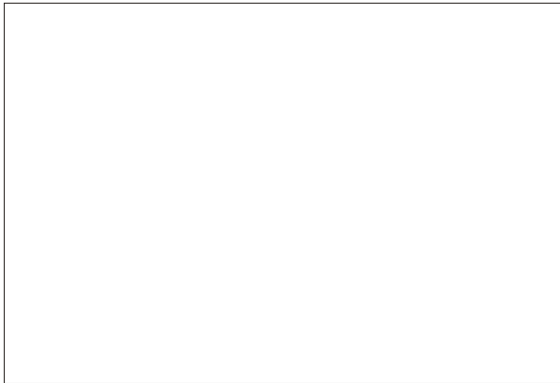

Rectifier Diode



Type	V_{RSM}	V_{RRM}
SMDC1-800	700-1700	600-1600
SMDC2-800	900-2300	1600-2200
SMDC3-800	2500-3700	2400-3600

Type	I_{FAVM} $T_c=55^\circ\text{C}$	I_{FRMS}	I_{FSM}	I_{RRM}	i^2t	V_{FM}	I_{FM}	V_{FO}	r_F	T_{VJM}	R_{thJC}	F
	A	A	kA	mA	kA^2s	V	A	V	$\text{m}\Omega$	$^\circ\text{C}$	K/W	kN
SMDCx-800	800	1450	12	80	720	2.2	2400	1.00	0.40	150	0.022	25

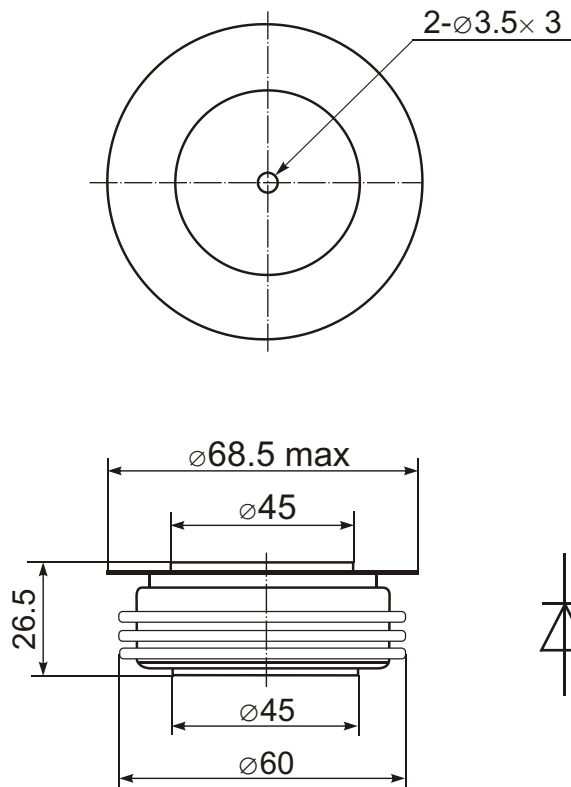

Features:

- Hermetic metal case with ceramic insulator
- Capsule packages for double sided cooling
- International standard case

Typical Applications:

- DC motor control
- AC motor soft starter
- Charging equipment