

SURFACE MOUNT CHIP LED LAMPS

1206 Package Chip Infrared LED

Part Number: IR15-21C/L10

Package outlines & Re-flow Profile

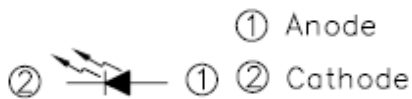
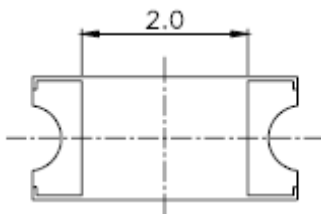
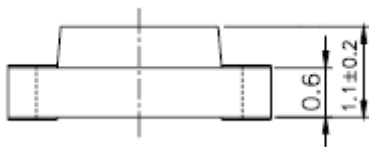
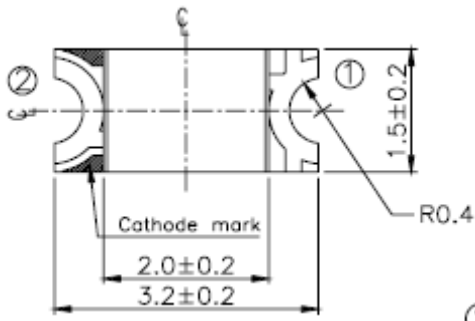

For Reflow Soldering

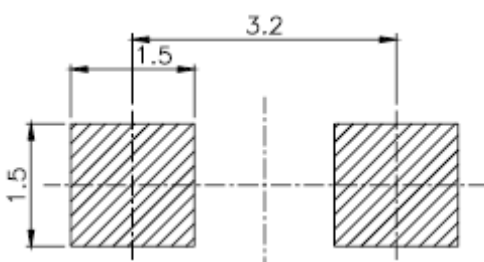

■Reflow Temp/Time

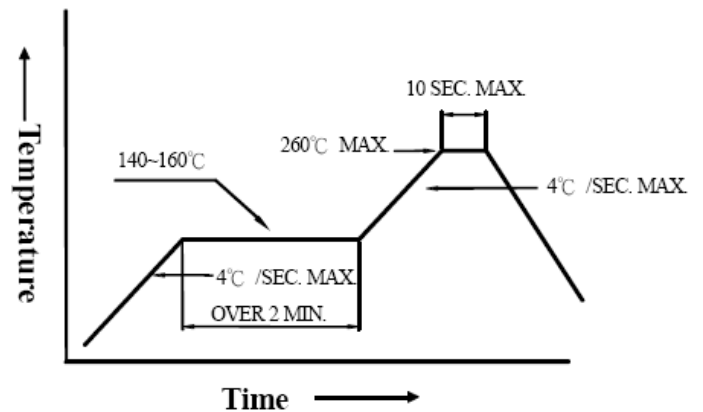

■Soldering iron

Basic spec is $\leq 5\text{sec}$ when 260°C . If temperature is higher, time should be shorter ($+10^{\circ}\text{C} \rightarrow -1\text{sec}$). Power dissipation of iron should be smaller than 15W, and temperatures should be controllable. Surface temperature of the device should be under 230°C .

ITEM	MATERIALS
Resin (mold)	Epoxy
Lens color	Water Clear
Printed circuit board	BT
Dice	GaAlAs
Emitted color	Infrared

NOTES:

1. All dimensions are in millimeters (inches);
2. Tolerances are $\pm 0.1\text{mm}$ (0.004inch) unless otherwise noted.

SURFACE MOUNT CHIP LED LAMPS

Part Number: IR15-21C/L10

ELECTRO-OPTICAL CHARACTERISTICS**(T_A=25°C)**

Parameter	Test Condition	Symbol	Value	Unit
Viewing angle at 50% I _v	I _F =10mA	2θ 1/2	160	Deg
Forward voltage (Typ.)	I _F =20mA	V _F	1.20	V
(Max.)			1.50	
Radiant Intensity (Min.)	I _F =20mA	I _v	0.20	mW/sr
(Typ.)			0.80	
Wavelength	I _F =20mA	λ _p	940	nm
Spectral Line Half-Width	I _F =20mA	Δλ	45	nm
Peak pulsing current (1/10 duty f=1kHz)		I _{FP}	1.0	A

Absolute maximum ratings**(T_A=25°C)**

Parameter	Symbol	Value	Unit
Forward current	I _F	65	mA
Reverse voltage	V _R	5	V
Reverse current	I _R	100	μA
Power Dissipation	P _D	130	mW
Operating temperature range	Top	-25 ~+85	°C
Storage temperature range	Tstg	-40 ~+100	°C
Lead soldering temperature	260°C For 5 Seconds		

SURFACE MOUNT CHIP LED LAMPS**Part Number: IR15-21C/L10****Test items and results of reliability**

NO.	Item	Test Conditions	Test Hours/ Cycles	Sample Sizes	Failure Judgement Criteria	Ac/Re
1	REFLOW Soldering	TEMP. : 260°C±5°C 5secs	6Mins	22pcs	$I_R \geq U \times 2$ $E_e \leq L \times 0.8$ $V_F \geq U \times 1.2$ U : Upper Specification Limit L : Lower Specification Limit	0/1
2	Temperature Cycle	H : +100°C 15mins \updownarrow 5mins L : -40°C 15mins	50Cycles	22pcs		0/1
3	Thermal Shock	H : +100°C 5mins \updownarrow 10secs L : -10°C 5mins	50Cycles	22pcs		0/1
4	High Temperature Storage	TEMP. : +100°C	1000hrs	22pcs		0/1
5	Low Temperature Storage	TEMP. : -40°C	1000hrs	22pcs		0/1
6	DC Operating Life	$I_F = 20\text{mA}$	1000hrs	22pcs		0/1
7	High Temperature/ High Humidity	85°C / 85% R.H	1000hrs	22pcs		0/1

* Refer to reliability test standard specification for in this line.

SURFACE MOUNT CHIP LED LAMPS**Part Number: IR15-21C/L10****Typical Optical-Electrical Characteristic Curves**◆ **TYPICAL ELECTRICAL-OPTICAL CHARACTERISTICS CURVES**RELATIVE INTENSITY VS. WAVELENGTH(λ_p)

- | | |
|---|----------------------------------|
| (1) GaAsP/GaAs 655nm/Red | (9)- GaAlAs 880nm |
| (2) GaP 568nm/ Yellow Green | (10)-GaAs/GaAs&GaAlAs/GaAs 940nm |
| (3) GaAsP/GaP 585nm/Yellow | (A)- GaN 430nm/Blue |
| (4) GaAsP/GaP 635nm/Orange & Hi-Eff Red | (B)- InGaN 470nm/Blue |
| (5) GaP 700nm/Bright Red | (C)- InGaN 502nm/Ultra Green |
| (6) GaAlAs/GaAs 660nm/Super Red | (D)- InGaN 523nm/Ultra Green |
| (8) GaAsP/GaP 610nm/Super Red | |

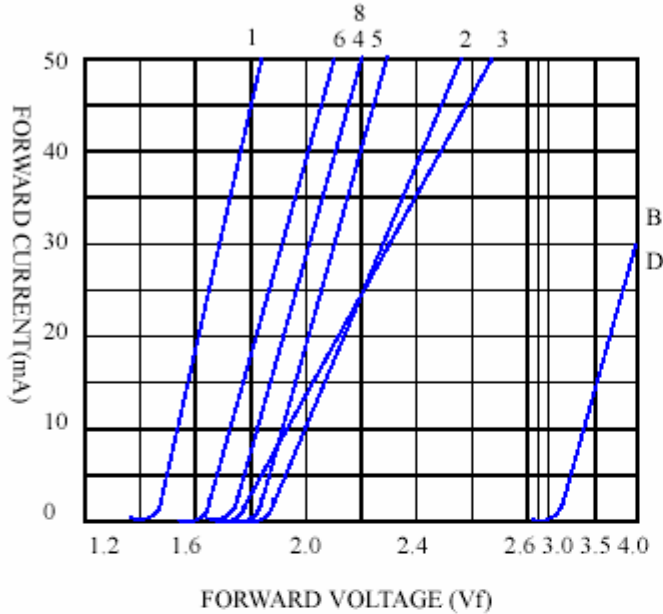
SURFACE MOUNT CHIP LED LAMPS**Part Number: IR15-21C/L10****Typical Optical-Electrical Characteristic Curves**◆ **CHARACTERISTICS DIAGRAMS****FORWARD CURRENT VS. FORWARD VOLTAGE****RELATIVE LUMINOUS INTENSITY VS. FORWARD CURRENT****FORWARD CURRENT VS. AMBIENT TEMPERATURE**