

GaAs MMIC +3V SOT26 TRANSMIT/ RECEIVE SWITCH, DC - 2.0 GHz

Typical Applications

The HMC226 / HMC226E is ideal for:

- 900 MHz ISM/Cellular
- 1900 MHz PCS

Features

- Low Insertion Loss: 0.6 dB
- Ultra Small Package: SOT26
- High Input P1dB: +35 to +38 dBm
- High Input IP3: +55 to +61 dBm
- Positive Control: 0/+3V to 0/+8V
- Included in the HMC-DK005 Designer's Kit

Functional Diagram

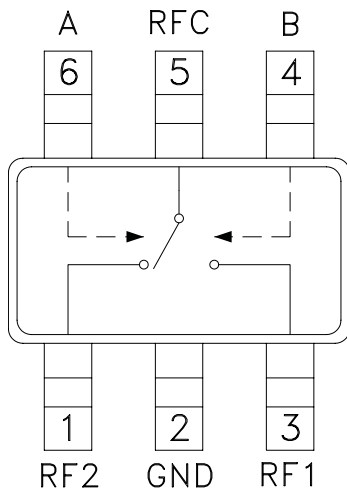

General Description

The HMC226 & HMC226E are low-cost SPDT switches in 6-lead SOT26 packages for use in transmit-receive applications which require very low distortion at high signal power levels. The device can control signals from DC to 2.0 GHz and is especially suited for 450 MHz, 900 MHz, and 1.8 - 2.0 GHz applications with 0.5 to 0.8 dB loss. The design provides exceptional P1dB and intermodulation performance; a +35 dBm 1dB compression point and +55 dBm third order intercept at +3 volt bias. RF1 and RF2 are reflective opens when "Off". On-chip circuitry allows single positive supply operation at very low DC current with control inputs compatible with CMOS and most TTL logic families.

Electrical Specifications, $T_A = +25^\circ \text{C}$, $V_{ctl} = 0/+3 \text{Vdc}$, 50 Ohm System

Parameter	Frequency	Min.	Typ.	Max.	Units
Insertion Loss	DC - 0.5 GHz		0.5	0.8	dB
	DC - 1.0 GHz		0.6	0.9	dB
	DC - 2.0 GHz		0.8	1.2	dB
Isolation	DC - 0.5 GHz	23	26		dB
	DC - 1.0 GHz	17	20		dB
	DC - 2.0 GHz	12	15		dB
Return Loss	DC - 0.5 GHz	23	27		dB
	DC - 1.0 GHz	21	25		dB
	DC - 2.0 GHz	14	18		dB
Input Power for 1 dB Compression	0.3 - 2.0 GHz	0/5V Control	34	38	dBm
		0/3V Control	31	35	dBm
Input Third Order Intercept (Two-Tone Input Power = +26 dBm Each Tone)	0.3 - 2.0 GHz	0/5V Control		61	dBm
		0/3V Control		55	dBm
Switching Characteristics	DC - 2.0 GHz	tRISE, tFALL (10/90% RF)		70	ns
		tON, tOFF (50% CTL to 10/90% RF)		140	ns



GaAs MMIC +3V SOT26 TRANSMIT/ RECEIVE SWITCH, DC - 2.0 GHz

Insertion Loss vs Temperature

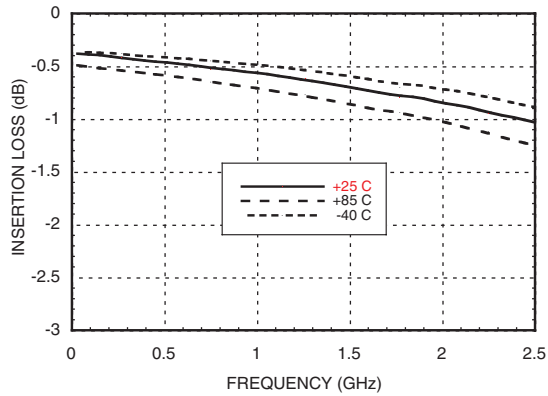

Isolation

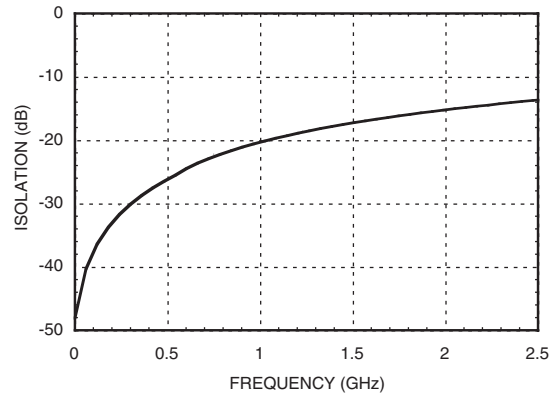

Return Loss

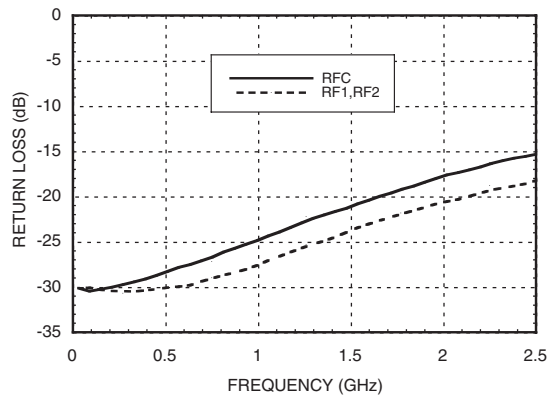



GaAs MMIC +3V SOT26 TRANSMIT/ RECEIVE SWITCH, DC - 2.0 GHz

Input 0.1 and 1.0 dB Compression vs. Control Voltage @ 900 MHz

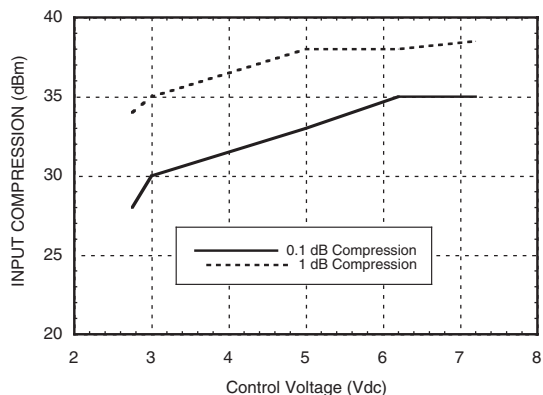

Compression vs. Control Voltage @ 900 MHz

Control Input	Input Power for 0.1 dB Compression	Input Power for 1.0 dB Compression
(Vdc)	(dBm)	(dBm)
+3	30	35
+5	33	38
+7	35	38.5

Caution: Do not operate continuously at power levels >1 dB compression and do not "hot switch" power levels greater than +23dBm ($V_{CTL} = +3Vdc$).

Truth Table

*Control Input Voltage Tolerances are ± 0.2 Vdc.

Control Input*		Control Current		Signal Path State	
A (Vdc)	B (Vdc)	Ia (uA)	Ib (uA)	RF to RF1	RF to RF2
0	+3	-5	5	ON	OFF
+3	0	5	-5	OFF	ON
0	+5	-10	10	ON	OFF
+5	0	10	-10	OFF	ON
0	+8	-45	45	ON	OFF
+8	0	45	-45	OFF	ON

DC Blocks are required at ports RFC, RF1 and RF2.

GaAs MMIC +3V SOT26 TRANSMIT/ RECEIVE SWITCH, DC - 2.0 GHz

Absolute Maximum Ratings

Max. Input Power ($V_{CTL} = 0/+3V$)	0.05 GHz 0.5 - 2 GHz	+27 dBm +36 dBm
Control Voltage Range (A & B)		-0.2 to +12 Vdc
Storage Temperature		-65 to +150 °C
Operating Temperature		-40 to +85 °C
ESD Sensitivity (HBM)		Class 1A



ELECTROSTATIC SENSITIVE DEVICE
OBSERVE HANDLING PRECAUTIONS

Outline Drawing

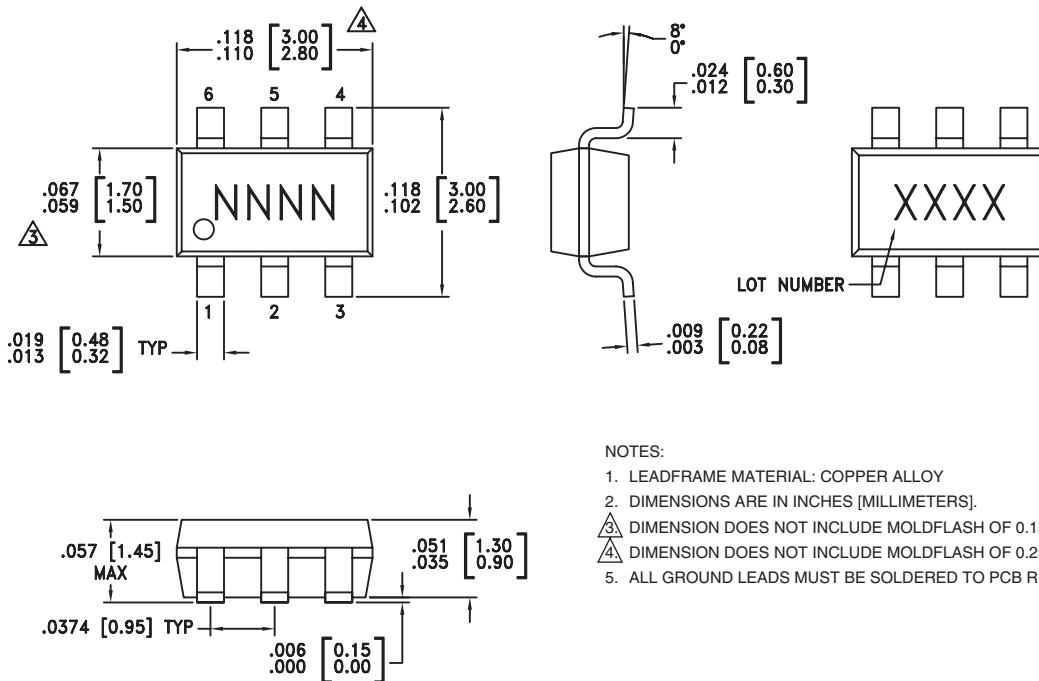

Package Information

Part Number	Package Body Material	Lead Finish	MSL Rating	Package Marking ^[3]
HMC226	Low Stress Injection Molded Plastic	Sn/Pb Solder	MSL1 ^[1]	H226 XXXX
HMC226E	RoHS-compliant Low Stress Injection Molded Plastic	100% matte Sn	MSL1 ^[2]	226E XXXX

[1] Max peak reflow temperature of 235 °C

[2] Max peak reflow temperature of 260 °C

[3] 4-Digit lot number XXXX

For price, delivery, and to place orders, please contact Hittite Microwave Corporation:
20 Alpha Road, Chelmsford, MA 01824 Phone: 978-250-3343 Fax: 978-250-3373
Order On-line at www.hittite.com

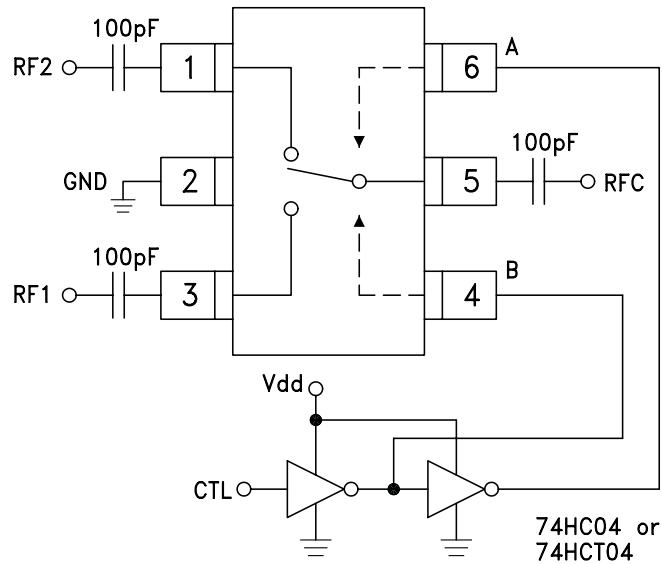
Typical Application Circuit

Notes:

1. Set logic gate and switch Vdd = +3V to +5V and use HCT series logic to provide a TTL driver interface.
2. Control inputs A/B can be driven directly with CMOS logic (HC) with Vdd of 3 to 8 Volts applied to the CMOS logic gates.
3. DC Blocking capacitors are required for each RF port as shown. Capacitor value determines lowest frequency of operation.
4. Highest RF signal power capability is achieved with V set to +10V. The switch will operate properly (but at lower RF power capability) at bias voltages down to +3V.

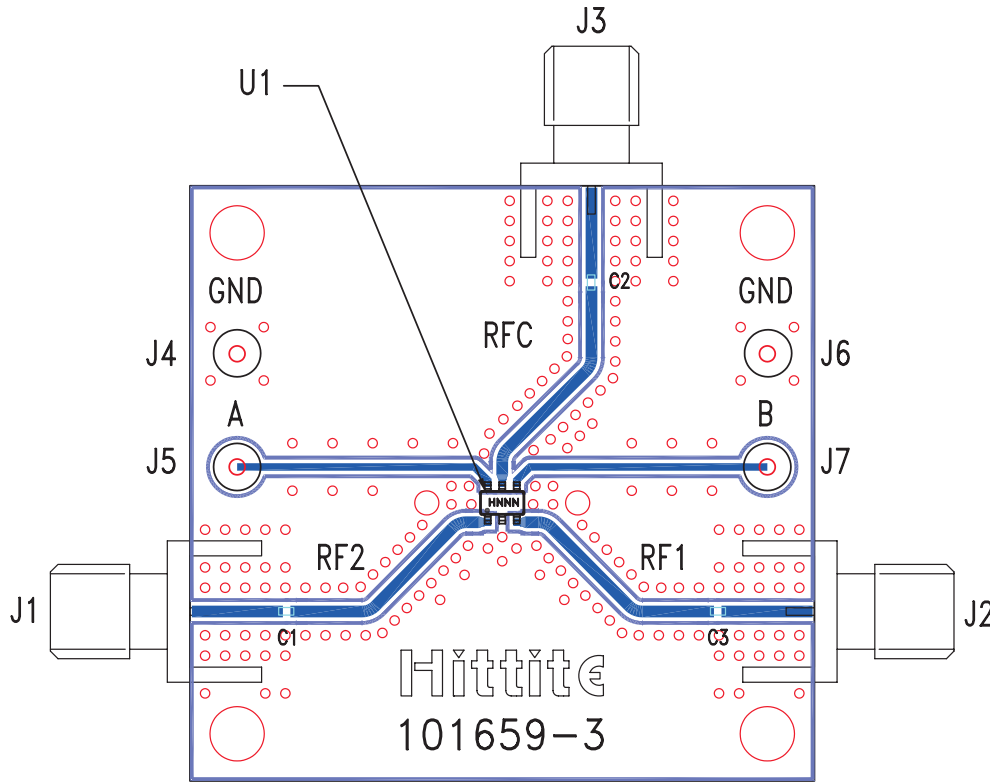
Evaluation Circuit Board



List of Materials for Evaluation PCB 101675 [1]

Item	Description
J1 - J3	PCB Mount SMA RF Connector
J4 - J7	DC Pin
C1 - C3	330 pF capacitor, 0402 Pkg.
U1	HMC226 / HMC226E T/R Switch
PCB [2]	101659 Evaluation PCB

[1] Reference this number when ordering complete evaluation PCB

[2] Circuit Board Material: Rogers 4350

The circuit board used in the final application should be generated with proper RF circuit design techniques. Signal lines at the RF port should have 50 ohm impedance and the package ground leads and package bottom should be connected directly to the ground plane similar to that shown above. The evaluation circuit board shown above is available from Hittite Microwave Corporation upon request.