

2W PACKAGED POWER PHEMT

FEATURES:

- 33 dBm Output Power (P1dB) @1.8GHz
- 14 dB Power Gain (G1dB) @1.8GHz
- 46 dBm Output IP3
- 10V Operation
- 50% Power-Added Efficiency
- Evaluation Boards Available
- Usable Gain to 4GHz

PACKAGE:

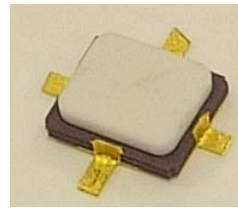

GENERAL DESCRIPTION:

The FPD2000AS is a packaged depletion mode AlGaAs/InGaAs pseudomorphic High Electron Mobility Transistor (pHEMT), optimized for power applications in L-Band. The surface-mount package has been optimized for low parasitics.

TYPICAL APPLICATIONS:

- Drivers or output stages in PCS/Cellular base station transmitter amplifiers
- Power applications in WLL/WLAN and WiMax (3.5GHz) amplifiers

ELECTRICAL SPECIFICATIONS:

PARAMETER	SYMBOL	CONDITIONS	MIN	TYP	MAX	UNITS
Power at 1dB Gain Compression	P1dB	VDS = 10V; IDS = 350 mA ΓS and ΓL tuned for Optimum IP3	32	33		dBm
Power Gain at dB Gain Compression	G1dB	VDS = 10V; IDS = 350 mA ΓS and ΓL tuned for Optimum IP3	12.5	14.0		
Maximum Stable Gain S21/S12	MSG	VDS = 10 V; IDS = 350 mA PIN = 0dBm, 50Ω system		20		dB
Power-Added Efficiency at 1dB Gain Compression	PAE	VDS = 10V; IDS = 350 mA ΓS and ΓL tuned for Optimum IP3		45		%
3rd-Order Intermodulation Distortion	IM3	VDS = 10V; IDS = 350 mA ΓS and ΓL tuned for Optimum IP3 POUT = 22 dBm		-47		dBc
Saturated Drain-Source Current	IDSS	VDS = 1.3 V; VGS = 0 V		1150		mA
Maximum Drain-Source Current	IMAX	VDS = 1.3 V; VGS ≅ +1 V		1800		mA
Transconductance	GM	VDS = 1.3 V; VGS = 0 V		1200		mS
Gate-Source Leakage Current	IGSO	VGS = -3 V		35	85	μA
Pinch-Off Voltage	VP	VDS = 1.3 V; IDS = 4 mA	0.7	0.9	1.4	V
Gate-Source Breakdown Voltage	VBDGS	IGS = 4 mA	6			V
Gate-Drain Breakdown Voltage	VBDGD	IGD = 4 mA	20			V
Thermal Resistance (channel-to-case)	θCC	See Note on following page		20		°C/W

Note: T_{AMBIENT} = 22°; RF specification measured at f = 1850 MHz using CW signal (except as noted)

ABSOLUTE MAXIMUM RATING¹:

PARAMETER	SYMBOL	TEST CONDITIONS	ABSOLUTE MAXIMUM
Drain-Source Voltage	VDS	-3V < VGS < -0.5V ⁷	12V
Gate-Source Voltage	VGS	0V < VDS < +8V	-3V
Drain-Source Current	IDS	For VDS < 2V	IDSS
Gate Current	IG	Forward / reverse current	+15/-2mA
RF Input Power ²	PIN	Under any acceptable bias state	29.5dBm
Channel Operating Temperature	TCH	Under any acceptable bias state	175°C
Storage Temperature	TSTG	Non-Operating Storage	-40°C to 150°C
Total Power Dissipation ³	PTOT	See De-Rating Note below	7.6W

Notes:

¹ T_{Ambient} = 22°C unless otherwise noted; exceeding any one of these absolute maximum ratings may cause permanent damage to the device; Users should avoid exceeding 80% of 2 or more Limits simultaneously

² Max. RF Input Limit must be further limited if input VSWR > 2.5:1

³ Total Power Dissipation defined as: $P_{TOT} \equiv (P_{DC} + P_{IN}) - P_{OUT}$,
 where P_{DC}: DC Bias Power, P_{IN}: RF Input Power, P_{OUT}: RF Output Power
 Total Power Dissipation to be de-rated as follows above 22°C:

$$P_{TOT} = 7.6 - (0.05W/^{\circ}C) \times T_{PACK}$$

where T_{PACK} = source tab lead temperature above 22°C

(Coefficient of de-rating formula is the Thermal Conductivity)

Example: For a 55°C carrier temperature: $P_{TOT} = 7.6W - (0.05 \times (55 - 22)) = 5.95W$

⁵ For optimum heat sinking, metal-filled through (Source) via holes should be used directly below the central metallized ground pad on the bottom of the package

⁶ Thermal Resistivity: The nominal value of 20°C/W is measured with the package mounted on a large heatsink with thermal compound to ensure adequate (unsoldered) contact. The package temperature is referred to the Source leads

⁷ Operating at absolute maximum VD continuously is not recommended. If operation is considered then IDS must be reduced in order to keep the part within it's thermal power dissipation limits. Therefore VGS is restricted to <-0.5V.

BIASING GUIDELINES:

- Active bias circuits provide good performance stabilization over variations of operating temperature, but require a larger number of components compared to self-bias or dual-biased. Such circuits should include provisions to ensure that Gate bias is applied before Drain bias, otherwise the pHEMT may be induced to self-oscillate.
- Dual-bias circuits are relatively simple to implement, but will require a regulated negative voltage supply for depletion-mode devices such as the FPD2000AS.
- The recommended 350mA bias point is nominally a Class AB mode. A small amount of RF gain expansion prior to the onset of compression is normal for this operating point.

RECOMMENDED OPERATING BIAS CONDITIONS:

- Drain-Source Voltage: From 5V to 10V
- Quiescent Current: From 25% I_{DSS} to 55% I_{DSS}

TYPICAL MEASURED RF PERFORMANCE:

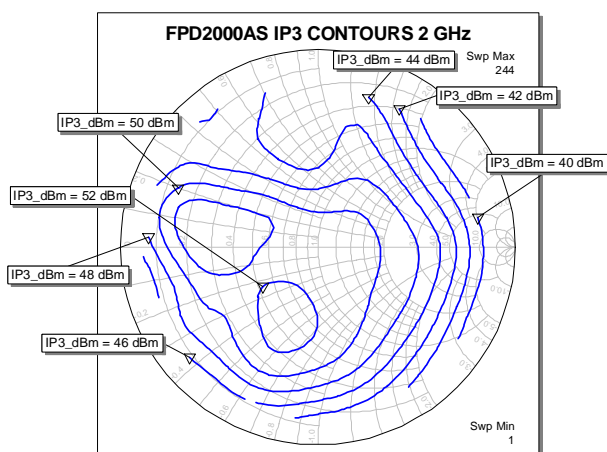
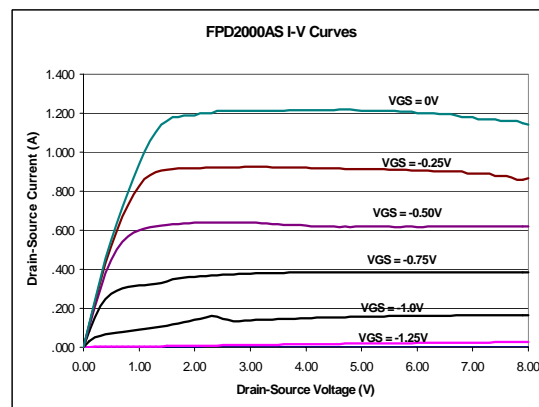
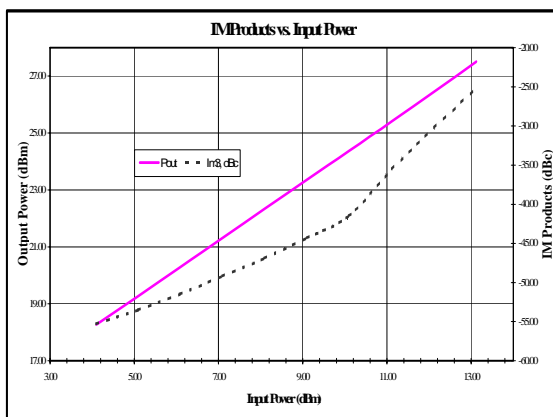
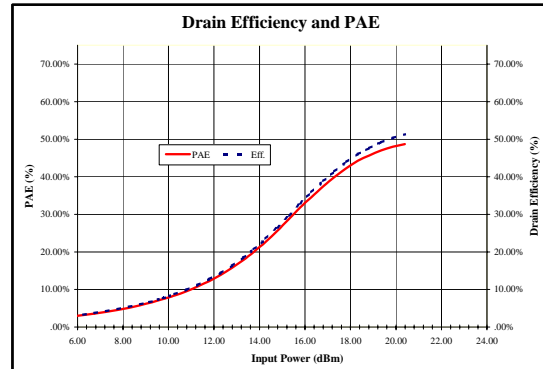
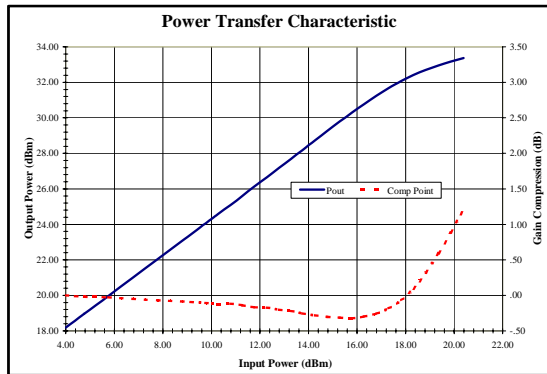
 Note: Measurement Conditions $T_{\text{AMBIENT}} = 22^{\circ}\text{C}$ unless otherwise stated ($V_{\text{DS}}=10\text{V}$, $I_{\text{DS}}=350\text{mA}$, $f=1800\text{MHz}$)

NOTE: IP3 contours generated with $P_{\text{IN}} = 11\text{dB}$ back-off from $P_{1\text{dB}}$. Local maxima for best linearity located at:
 $\Gamma_L = 15 + j4.5 \Omega$ and $\Gamma_L = 28 - j25 \Omega$
 with $\Gamma_S = 9.5 - i4 \Omega$

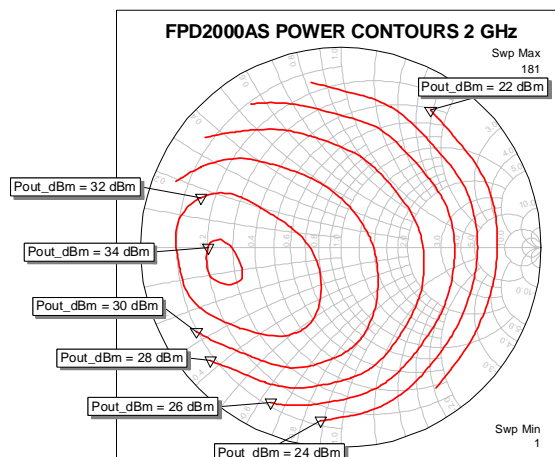

NOTE: Power contours measured at constant input power, level set to meet nominal $P_{1\text{dB}}$ rating at optimum match point. Optimum match:
 $\Gamma_S = 3 - j6 \Omega$ and $\Gamma_L = 11 - j3 \Omega$

TYPICAL MEASURED RF PERFORMANCE:

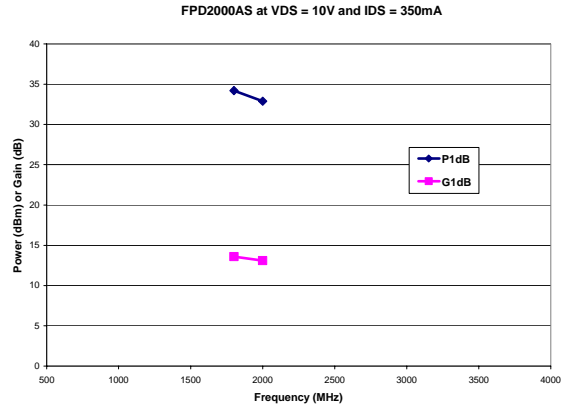
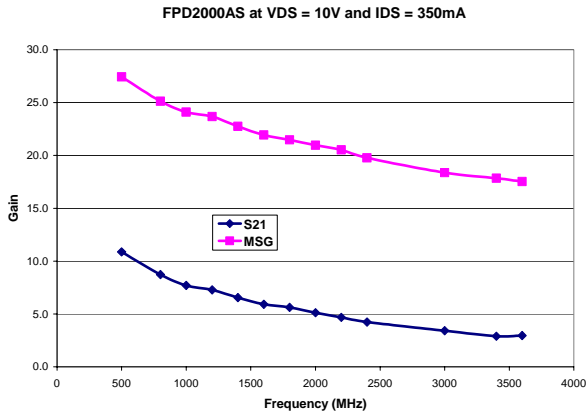
 Note: Measurement Conditions $T_{AMBIENT} = 22^{\circ}C$ unless otherwise stated (VDS=10V, IDS=200mA)

AS PACKAGE OUTLINE AND RECOMMENDED PC BOARD LAYOUT:

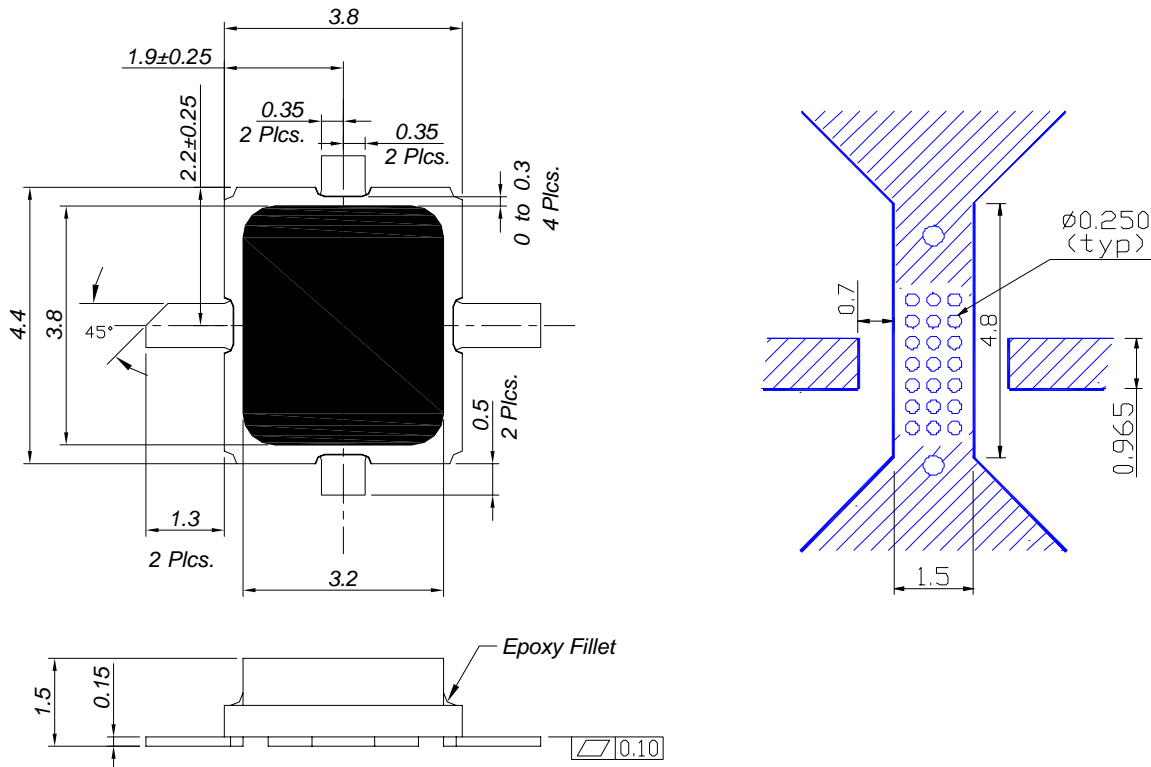
(dimensions in millimeters – mm)



All Dimnsions in mm

General Tolerance: .xx ± 0.05 .x ± 0.15

For best positional accuracy in auto pick and place device should be referenced directly from the leads

REFERENCE DESIGN (3.4 – 3.5GHz):

PARAMETER	UNIT	PERFORMANCE
Frequency	GHz	3.4 to 3.5
Gain	dB	10
P1dB	dBm	33
IM3 @22dBm Pout SCL	dBc	-45dBc
S11	dB	-6
S22	dB	-15
Vd	V	10
Vg	V	-0.6 to -0.9
Id	mA	350

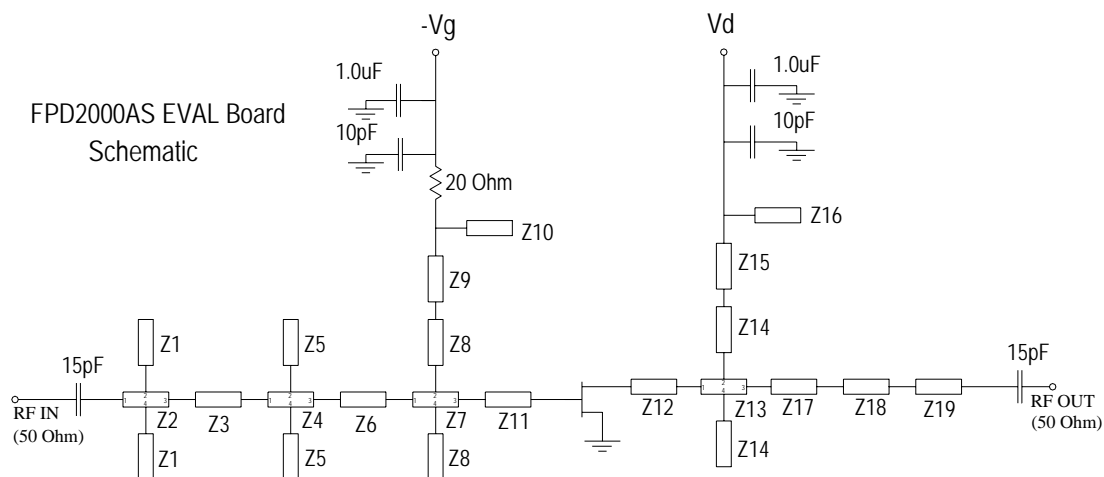
SCHEMATIC:

Desc.	Value
Z1	0.050" x 1.000" Microstrip
Z2	W1=0.020" W2=0.050" W3=0.020" W4=0.050" Microstrip Cross
Z3	0.020" x 0.100" Microstrip
Z4	W1=0.020" W2=0.050" W3=0.020" W4=0.050" Microstrip Cross
Z5	0.050" x 0.100" Microstrip
Z6	0.020" x 0.440" Microstrip
Z7	W1=0.020" W2=0.085" W3=0.020" W4=0.085" Microstrip Cross
Z8	0.085" x 0.254" Microstrip
Z9	0.015" x 0.296" Microstrip
Z10	0.360" x 90° Microstrip Radial Stub
Z16	0.420" x 90° Microstrip Radial Stub
Z11, Z12	0.040" x 0.040" Microstrip
Z13	W1=0.090" W2=0.200" W3=0.090" W4=0.200" Microstrip Cross
Z14	0.200" x 0.100" Microstrip
Z15	0.015" x 0.450" Microstrip
Z17	0.090" x 0.190" Microstrip
Z18	0.140" x 0.480" Microstrip
Z19	0.050" x 0.100" Microstrip

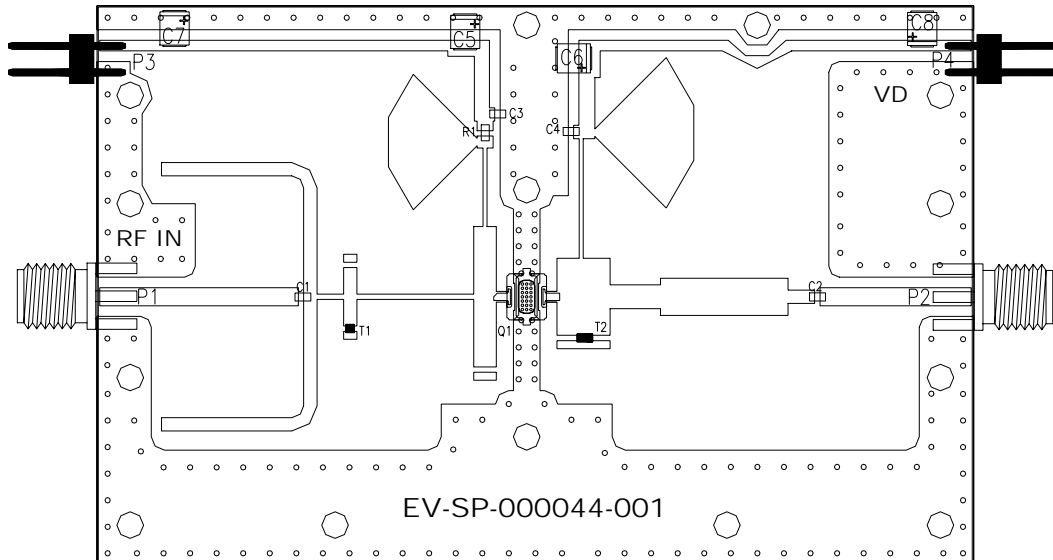
BOARD LAYOUT (3.4 – 3.5GHz):

Component	Description
R1	Resistor 0.06 x 0.03 20Ω 1/4W
C1, C2	Cap. 0.06 x 0.03 15pF
C3, C4	Cap. 0.06 x 0.03 10pF
C5, C6, C7, C8	Cap. SMD-B 1.0uF
P1, P2	Edge Mount RF Connector
P3, P4	2 Pin Header
T1, T2	Copper Tab
Q1	FPD2000AS
PCB	EV-SP-000016-001 (R4003, 30mil Thick)
Base Plate	TF-SP-000019-001

NOTE: AutoCAD™ drawing available on request

S-PARAMETERS:

Note: Biased @ 10V, 350mA

FREQ-GHZ	S11MAG	S11ANG	S21MAG	S21ANG	S12MAG	S12ANG	S22MAG	S22ANG
0.50	0.89	-151.40	12.52	96.06	0.02	23.09	0.41	-163.97
0.60	0.89	-158.58	10.57	91.14	0.02	21.17	0.41	-168.16
0.70	0.89	-164.23	9.14	86.95	0.02	20.24	0.42	-171.39
0.80	0.89	-168.91	8.06	83.20	0.02	19.30	0.42	-174.09
0.90	0.89	-172.86	7.20	79.78	0.03	18.90	0.42	-176.33
1.00	0.89	-176.35	6.51	76.60	0.03	18.57	0.42	-178.37
1.10	0.89	-179.44	5.93	73.62	0.03	18.50	0.42	179.80
1.20	0.89	177.74	5.45	70.77	0.03	18.46	0.42	178.18
1.30	0.89	175.11	5.05	68.02	0.03	18.41	0.43	176.66
1.40	0.88	172.67	4.70	65.34	0.03	18.34	0.43	175.27
1.50	0.88	170.35	4.40	62.72	0.03	18.30	0.43	173.92
1.60	0.88	168.17	4.13	60.18	0.03	18.25	0.43	172.69
1.70	0.88	166.09	3.89	57.70	0.03	18.34	0.43	171.34
1.80	0.88	164.11	3.69	55.24	0.03	18.22	0.43	170.15
1.90	0.88	162.17	3.50	52.76	0.03	18.00	0.43	168.95
2.00	0.88	160.30	3.34	50.37	0.03	18.00	0.43	167.90
2.10	0.88	158.48	3.19	48.01	0.03	18.01	0.43	166.84
2.20	0.88	156.67	3.05	45.65	0.03	17.70	0.43	165.65
2.30	0.88	155.01	2.93	43.35	0.03	17.42	0.43	164.73
2.40	0.88	153.30	2.81	41.02	0.03	17.44	0.43	163.72
2.50	0.88	151.64	2.71	38.72	0.04	16.81	0.43	162.73
2.60	0.88	150.05	2.61	36.43	0.04	16.69	0.43	161.59
2.70	0.88	148.54	2.52	34.20	0.04	16.42	0.43	160.71
2.80	0.88	147.00	2.44	31.95	0.04	16.22	0.43	159.70
2.90	0.88	145.28	2.36	29.69	0.04	15.56	0.43	158.58
3.00	0.88	143.93	2.29	27.42	0.04	15.49	0.43	157.76
3.10	0.88	142.45	2.23	25.22	0.04	14.94	0.43	156.78
3.20	0.88	141.02	2.16	23.03	0.04	14.53	0.43	155.89
3.30	0.88	139.58	2.11	20.81	0.04	14.10	0.43	154.94
3.40	0.88	138.21	2.05	18.59	0.04	13.33	0.43	154.07
3.50	0.88	136.87	2.00	16.40	0.04	12.89	0.43	153.19
3.60	0.88	135.65	1.95	14.24	0.05	12.15	0.43	152.58
3.70	0.88	134.47	1.90	12.24	0.05	11.80	0.43	151.58
3.80	0.87	129.67	1.94	8.92	0.05	10.05	0.42	148.11
3.90	0.87	127.78	1.91	6.50	0.05	9.06	0.42	146.79
4.00	0.87	125.78	1.88	3.95	0.05	7.84	0.42	145.39
4.10	0.86	123.84	1.84	1.48	0.05	6.72	0.42	143.97
4.20	0.86	121.77	1.81	-0.89	0.06	5.60	0.42	142.63
4.30	0.86	119.75	1.79	-3.25	0.06	4.45	0.42	141.09
4.40	0.86	117.52	1.76	-5.69	0.06	3.33	0.41	139.29
4.50	0.85	115.54	1.74	-8.29	0.06	2.14	0.41	137.87
4.60	0.85	113.68	1.71	-10.69	0.06	1.05	0.41	136.50
4.70	0.85	111.67	1.69	-13.07	0.06	-0.20	0.41	135.06
4.80	0.85	109.46	1.67	-15.55	0.06	-1.36	0.41	133.46
4.90	0.85	107.26	1.65	-18.04	0.07	-2.60	0.41	131.82
5.00	0.85	105.01	1.63	-20.54	0.07	-3.94	0.41	130.21

S-PARAMETERS (CONT.):

Note: Biased @ 10V, 350mA

FREQ-GHZ	S11MAG	S11ANG	S21MAG	S21ANG	S12MAG	S12ANG	S22MAG	S22ANG
5.10	0.85	102.67	1.61	-23.07	0.07	-5.34	0.41	128.50
5.20	0.85	100.31	1.59	-25.68	0.07	-6.87	0.41	126.81
5.30	0.84	97.99	1.58	-28.24	0.07	-8.40	0.41	125.07
5.40	0.84	95.60	1.56	-30.82	0.07	-9.89	0.41	123.35
5.50	0.84	93.23	1.54	-33.39	0.08	-11.46	0.41	121.57
5.60	0.84	90.81	1.52	-36.00	0.08	-12.98	0.40	119.83
5.70	0.84	88.26	1.50	-38.59	0.08	-14.50	0.41	117.91
5.80	0.84	85.69	1.49	-41.22	0.08	-16.11	0.41	116.04
5.90	0.84	83.17	1.47	-43.83	0.08	-17.66	0.41	114.18
6.00	0.83	80.66	1.45	-46.44	0.08	-19.28	0.41	112.34
6.10	0.83	78.11	1.44	-49.07	0.09	-21.12	0.41	110.62
6.20	0.83	75.46	1.42	-51.79	0.09	-23.29	0.41	108.63
6.30	0.83	72.84	1.40	-54.48	0.09	-25.03	0.41	106.57
6.40	0.83	70.23	1.39	-57.14	0.09	-26.82	0.41	104.45
6.50	0.83	67.48	1.37	-59.81	0.09	-28.64	0.41	102.37
6.60	0.83	64.77	1.35	-62.42	0.09	-30.28	0.41	100.18
6.70	0.82	62.13	1.33	-64.76	0.09	-31.41	0.41	98.06
6.80	0.82	59.92	1.32	-66.68	0.10	-30.95	0.40	97.13
6.90	0.83	57.56	1.32	-69.52	0.10	-32.92	0.41	96.12
7.00	0.83	54.88	1.31	-72.55	0.10	-35.78	0.42	94.11
7.10	0.83	52.08	1.29	-75.44	0.11	-38.26	0.42	91.84
7.20	0.83	49.37	1.28	-78.19	0.11	-40.46	0.42	89.62
7.30	0.83	46.66	1.26	-80.88	0.11	-42.52	0.43	87.37
7.40	0.83	44.02	1.24	-83.44	0.11	-44.17	0.43	85.28
7.50	0.83	41.53	1.23	-86.01	0.11	-45.73	0.43	83.74
7.60	0.83	38.88	1.22	-88.90	0.11	-48.21	0.43	81.63
7.70	0.83	36.18	1.20	-91.67	0.12	-50.47	0.44	79.39
7.80	0.83	33.64	1.19	-94.33	0.12	-52.59	0.44	77.14
7.90	0.84	31.05	1.17	-97.01	0.12	-54.72	0.44	74.97
8.00	0.84	28.44	1.16	-99.67	0.12	-56.85	0.44	72.73
8.10	0.84	25.95	1.15	-102.28	0.12	-58.91	0.45	70.54
8.20	0.84	23.49	1.13	-104.88	0.12	-60.91	0.45	68.43
8.30	0.84	21.07	1.12	-107.55	0.12	-62.95	0.45	66.26
8.40	0.84	18.55	1.11	-110.22	0.13	-65.03	0.45	64.01
8.50	0.84	16.14	1.09	-112.79	0.13	-66.97	0.46	61.79
8.60	0.84	13.74	1.08	-115.39	0.13	-68.91	0.46	59.50
8.70	0.84	11.39	1.07	-117.96	0.13	-70.86	0.46	57.23
8.80	0.84	8.95	1.06	-120.52	0.13	-72.85	0.46	55.01
8.90	0.85	6.61	1.04	-123.07	0.13	-74.90	0.46	52.71
9.00	0.85	4.26	1.03	-125.62	0.13	-76.87	0.46	50.40
9.10	0.85	1.89	1.02	-128.14	0.14	-78.87	0.46	48.10
9.20	0.85	-0.35	1.01	-130.70	0.14	-80.90	0.47	45.92
9.30	0.85	-2.77	1.00	-133.36	0.14	-83.07	0.47	43.66
9.40	0.85	-5.00	0.99	-135.96	0.14	-85.21	0.47	41.26
9.50	0.85	-7.40	0.98	-138.56	0.14	-87.34	0.47	38.92
9.60	0.85	-9.69	0.97	-141.19	0.14	-89.56	0.47	36.40
9.70	0.85	-12.14	0.97	-143.84	0.15	-91.85	0.47	33.98
9.80	0.85	-14.66	0.96	-146.52	0.15	-94.12	0.47	31.53
9.90	0.85	-17.20	0.95	-149.12	0.15	-96.23	0.48	29.14
10.00	0.85	-19.62	0.94	-151.71	0.15	-98.00	0.48	26.66

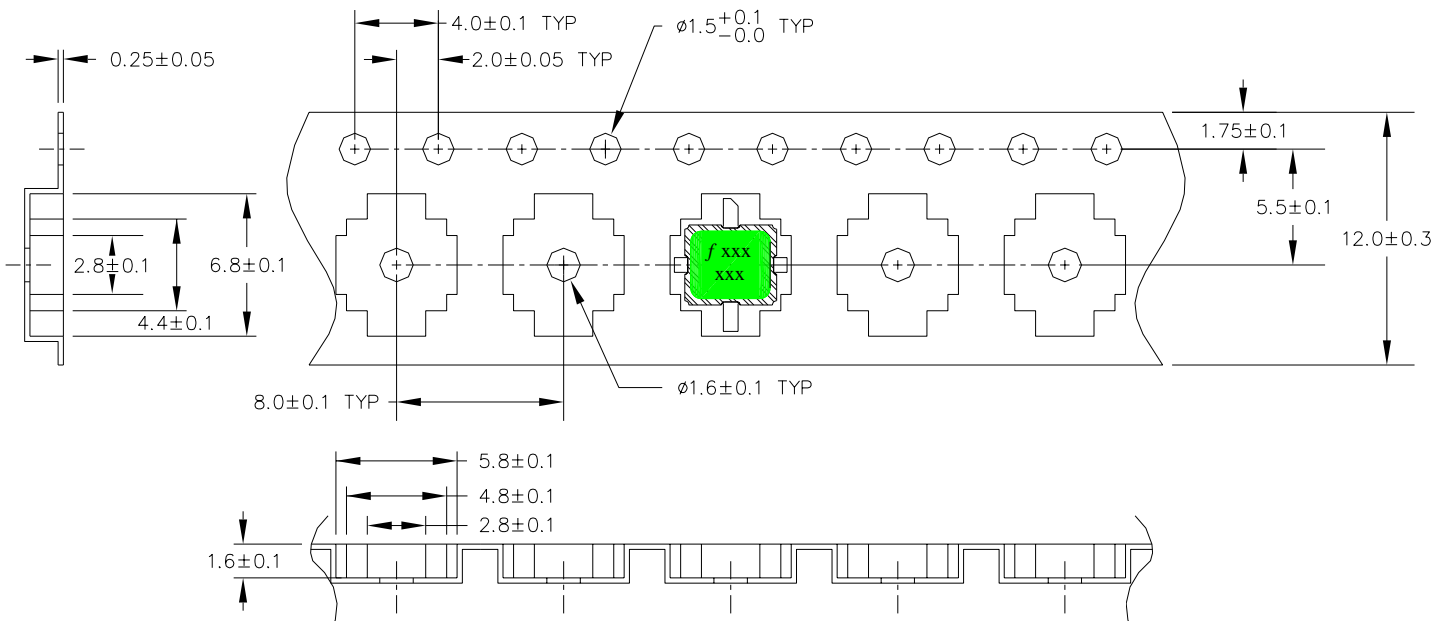
TAPE AND REEL DIMENSIONS AND PART ORIENTATION

DIMENSIONS ARE IN MM

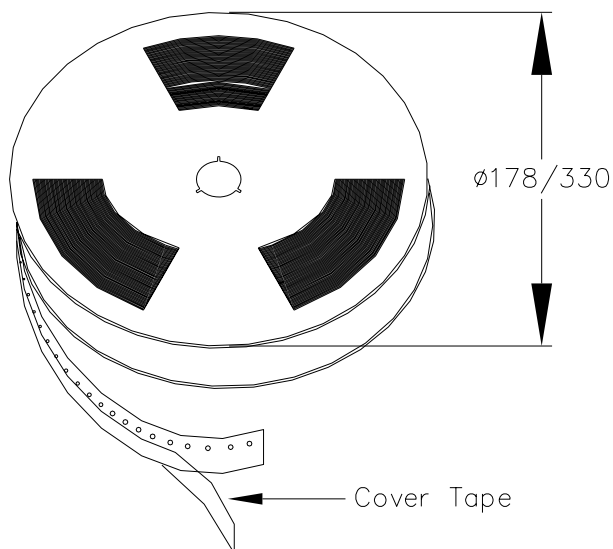
PACKAGE MARKING CODE
Example:
**f1ZD
P2F**
f = Filtronic
1ZD = Lot / Date Code
P2F = Status, Part Code, Part Type
**Parts per reel 178mm = 1000
330mm = 2500**

PREFERRED ASSEMBLY INSTRUCTIONS:

This package is compatible with both lead free and leaded solder reflow processes as defined within IPC/JEDEC J-STD-020C. The maximum package temperature should not exceed 260°C. Package leads are gold plated.

HANDLING PRECAUTIONS:

To avoid damage to the devices care should be exercised during handling.



Proper Electrostatic Discharge (ESD) precautions should be observed at all stages of storage, handling, assembly, and testing.

ESD/MSL RATING:

These devices should be treated as Class 1A (250-500 V) using the human body model as defined in JEDEC Standard No. 22-A114. Further information on ESD control measures can be found in MIL-STD-1686 and MIL-HDBK-263.

The device has a MSL rating of Level 1. To determine this rating, preconditioning was performed to the device per, the Pb-free solder profile defined within IPC/JEDEC J-STD-020C, Moisture / Reflow sensitivity classification for non-hermetic solid state surface mount devices

APPLICATION NOTES & DESIGN DATA:

Application Notes and design data including S-parameters, noise parameters and device model are available on request.

DISCLAIMERS:

This product is not designed for use in any space based or life sustaining/supporting equipment.

ORDERING INFORMATION:

PART NUMBER	DESCRIPTION
FPD2000AS	Packaged pHEMT
FPD2000AS-EB	Packaged pHEMT evaluation board EB-2000AS-AB (880MHz) EB-2000AS-AA (1.85GHz) EB-2000AS-AD (2.14GHz) EB-2000AS-AE (2.4GHz) EB-2000AS-AF (2.44GHz) EB-2000AS-AG (2.5 to 2.7GHz) EB-2000AS-AH (3.5GHz)