

5.0-14.0 GHz GaAs MMIC Packaged Driver Amplifier

Features

- ✕ 20 dB Gain
- ✕ 11 dBm P1dB
- ✕ 3x3 QFN Package
- ✕ Single Power Supply
- ✕ 5-7 V, 90 mA Self Bias
- ✕ On-Chip ESD Protection

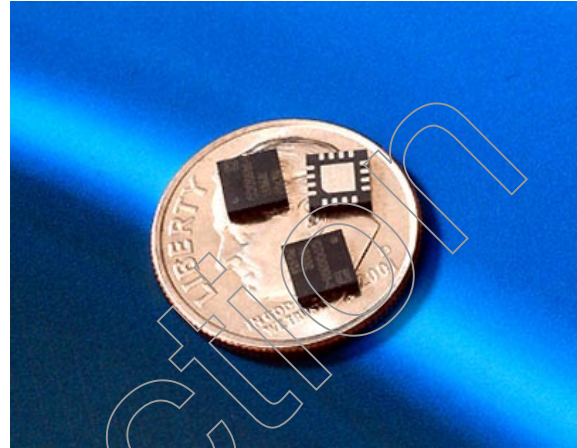

Circuit Description

Mimix Broadband's 3 stage 5.0 to 14.0 GHz driver amplifier is packaged in surface mount 3x3 QFN package. The device is a self-biased, single supply design with 20 dB gain and 11 dBm P1dB. This MMIC uses Mimix Broadband's 0.25um optical pHEMT process.

Absolute Maximum Ratings

Supply Voltage	+8 V
RF Input Power	+10 dBm
Storage Temperature (Tstg)	-55 °C to +125 °C
Junction Temperature	175 °C
Operating Temperature	-40 °C to +85°C

Operating this device beyond any of these parameters may cause permanent damage.

Electrical Characteristics (T=25°C)

Parameter	Units	Min.	Typ.	Max.
Frequency Range	GHz	5	-	14
Gain	dB	-	20	-
Input Return Loss		-	-12	-
Output P1dB	dBm	-	11	-
Output IP3	dBm	-	22	-
Supply Voltage	V	-	5	7
Current	mA		90	120

Typical Parameters (6V, 90 mA)

Parameter	Typical					
	5	7	9	11	13	14
Frequency	5	7	9	11	13	14
Gain	20.5	20.5	18.5	18.5	18.5	20
IP Return Loss	-15	-15	-17	-20	-10	-8
Op Return Loss	-14.5	-15	-11	-11	-9	-9
P1dB	13	13	10	10	10	11.5
OIP3	24.0	24.0	22.0	20.0	21.0	20.5

5.0-14.0 GHz GaAs MMIC Packaged Driver Amplifier



February 2008 - Rev 03-Feb-08

CMM0511-QT
RoHS

Driver Amplifier Measurements

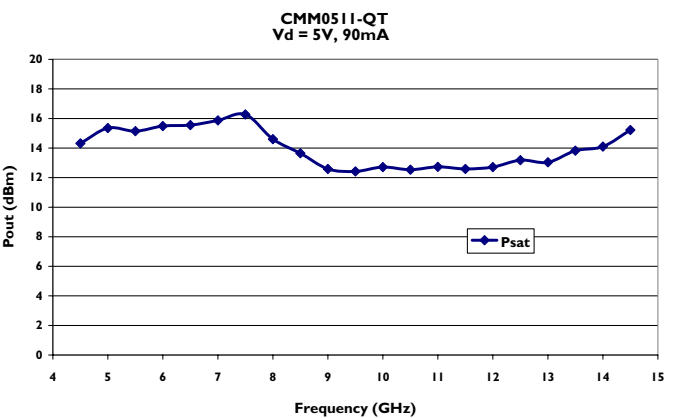
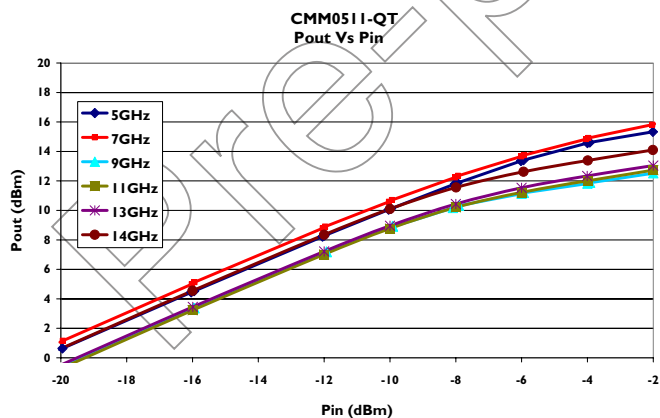
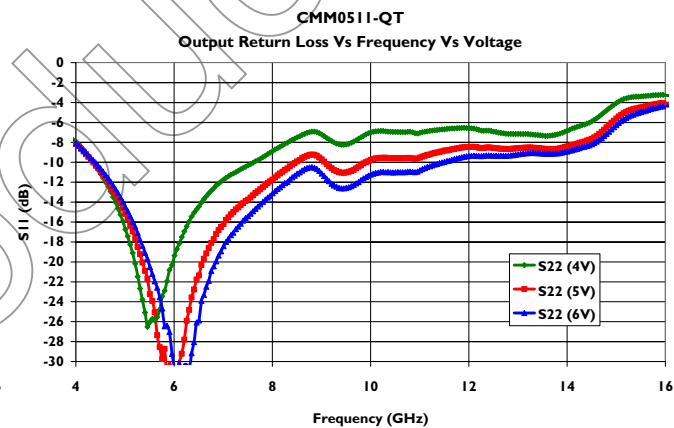
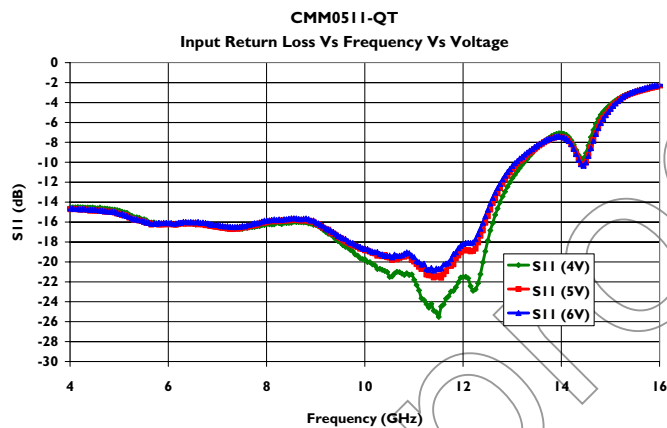
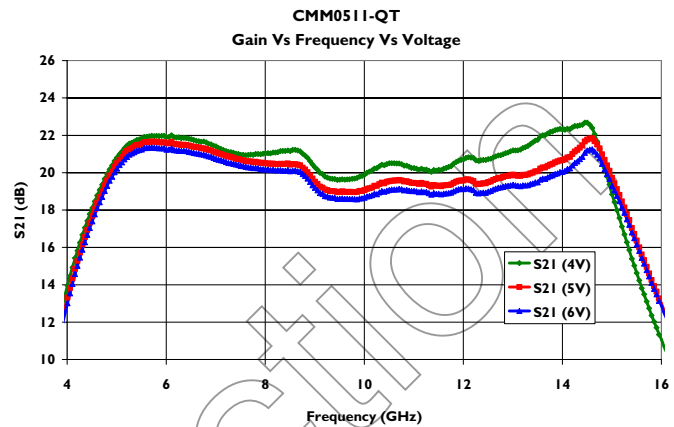
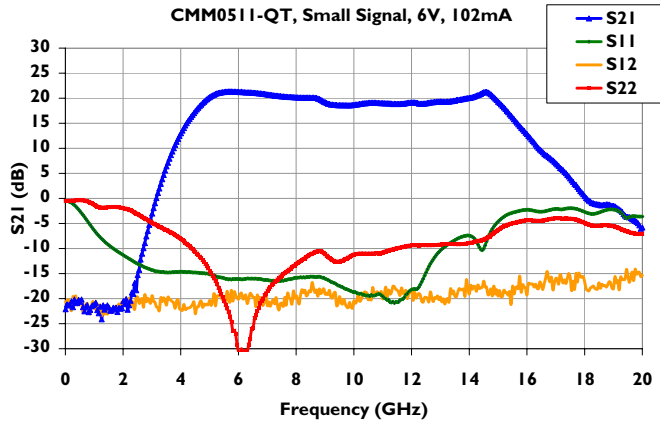

5.0-14.0 GHz GaAs MMIC Packaged Driver Amplifier



February 2008 - Rev 03-Feb-08

CMM0511-QT
RoHS

Driver Amplifier Measurements (cont.)

Gain Vs Frequency Vs Temperature
5V, 90mA

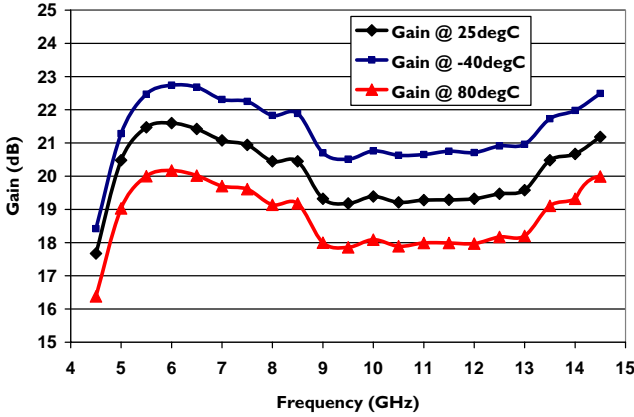

Gain Vs Frequency Vs Temperature
6V, 90mA

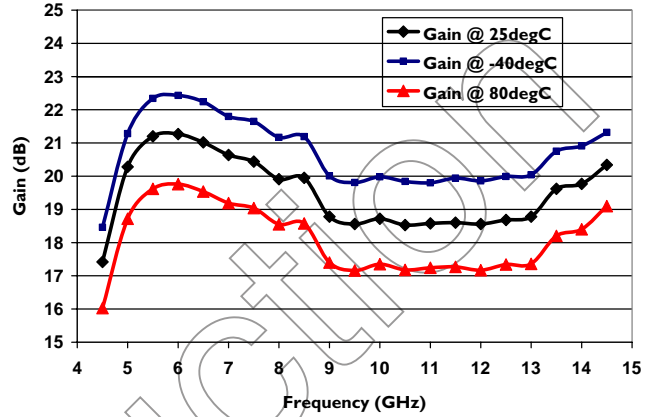

PI dB Vs Frequency Vs Temperature
5V, 90mA

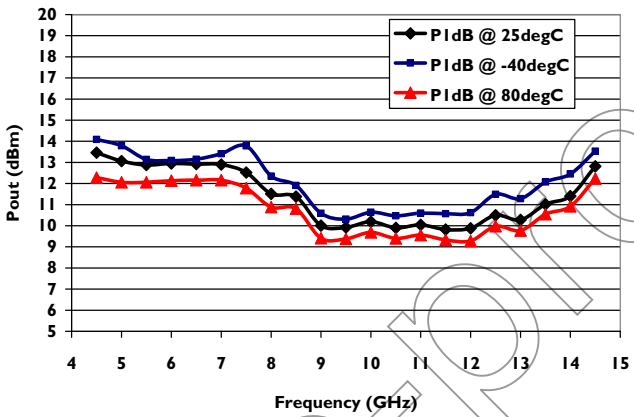

PI dB Vs Frequency Vs Temperature
6V, 90mA

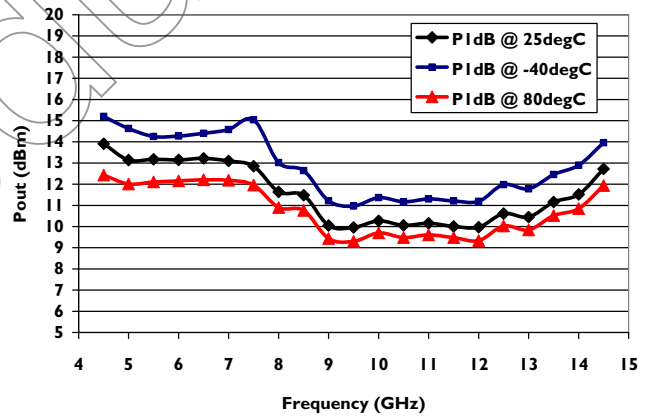

OIP3 Vs Frequency Vs Temperature
5V, 90mA

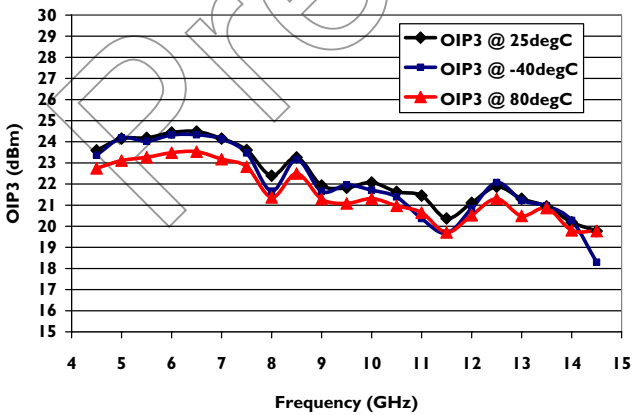

OIP3 Vs Frequency Vs Temperature
6V, 90mA

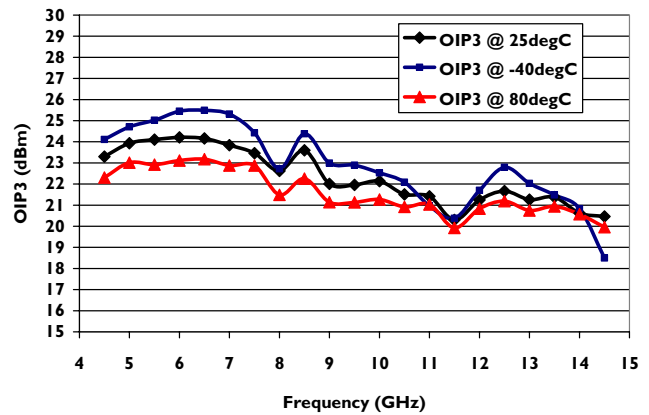

5.0-14.0 GHz GaAs MMIC Packaged Driver Amplifier

Evaluation Board Layout

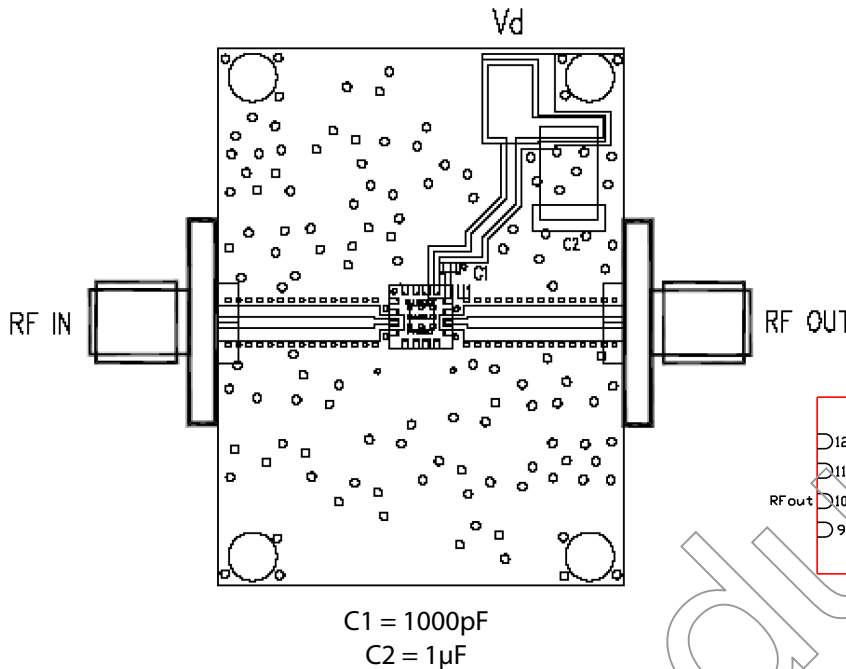

Package Pin-out Table

Pin Designator	Description
1,2,4,5,6,7,8,9, 11,12,14,15,16	NC
3	RF Input
10	RF Output
13	Vd

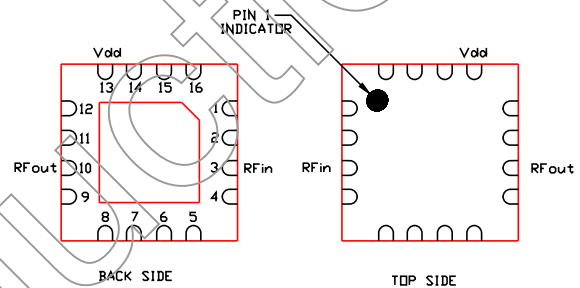

We recommend to ground all non-connected pins and to have as many via holes as possible under the ground paddle.

Evaluation Board Schematic

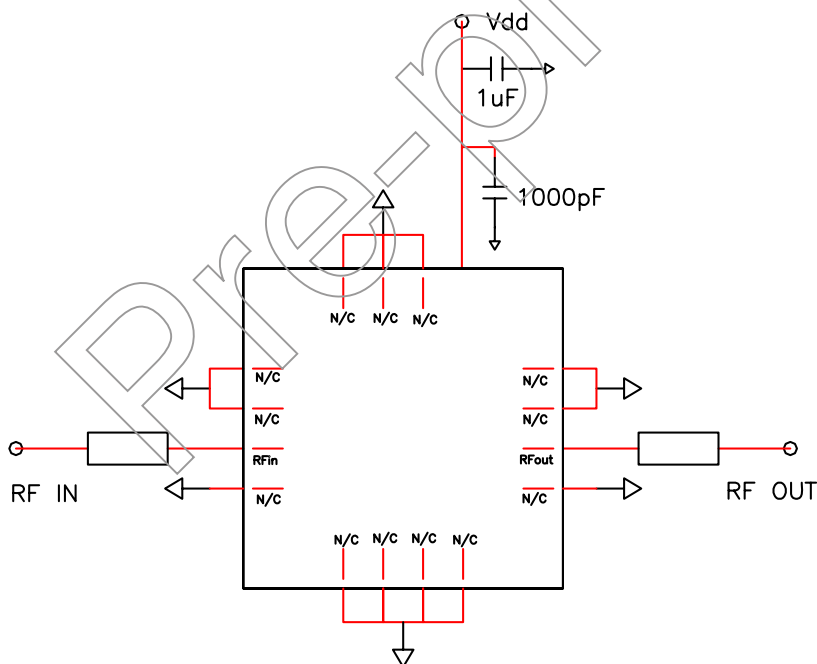

5.0-14.0 GHz GaAs MMIC Packaged Driver Amplifier

Package Outline and Assembly

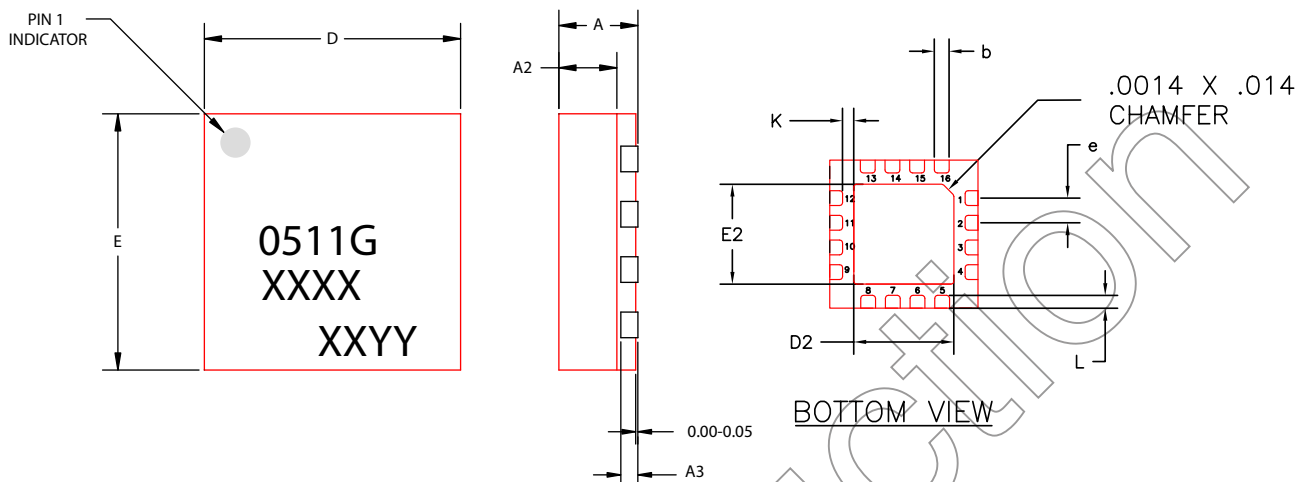

RECOMMENDED SOLDER PAD PITCH AND DIMENSIONS

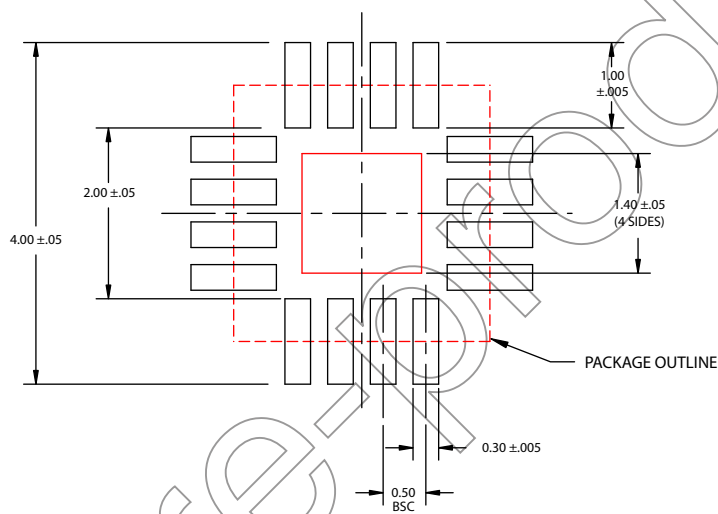

NOTE:

1. ALL DIMENSIONS ARE IN mm

	MIN	NOM	MAX
A	0.80	0.90	1.00
A3		0.20 REF	
A2	0	0.65	1.00
b	0.20	0.25	0.30
K	0.20	-	-
D		3.00 BSC	
E		3.00 BSC	
e		0.50	
D2	1.50	1.65	1.80
E2	1.50	1.65	1.80
L	0.16	0.26	0.36

5.0-14.0 GHz GaAs MMIC Packaged Driver Amplifier

Handling and Assembly Information

CAUTION! - Mimix Broadband MMIC Products contain gallium arsenide (GaAs) which can be hazardous to the human body and the environment. For safety, observe the following procedures:

- Do not ingest.
- Do not alter the form of this product into a gas, powder, or liquid through burning, crushing, or chemical processing as these by-products are dangerous to the human body if inhaled, ingested, or swallowed.
- Observe government laws and company regulations when discarding this product. This product must be discarded in accordance with methods specified by applicable hazardous waste procedures.

Life Support Policy - Mimix Broadband's products are not authorized for use as critical components in life support devices or systems without the express written approval of the President and General Counsel of Mimix Broadband. As used herein: (1) Life support devices or systems are devices or systems which, (a) are intended for surgical implant into the body, or (b) support or sustain life, and whose failure to perform when properly used in accordance with instructions for use provided in the labeling, can be reasonably expected to result in a significant injury to the user. (2) A critical component is any component of a life support device or system whose failure to perform can be reasonably expected to cause the failure of the life support device or system, or to affect its safety or effectiveness.

Package Attachment - This packaged product from Mimix Broadband is provided as a rugged surface mount package compatible with high volume solder installation. Vacuum tools or other suitable pick and place equipment may be used to pick and place this part. Care should be taken to ensure that there are no voids or gaps in the solder connection so that good RF, DC and ground connections are maintained. Voids or gaps can eventually lead not only to RF performance degradation, but reduced reliability and life of the product due to thermal stress.

Typical Reflow Profiles

Reflow Profile	SnPb	Pb Free
Ramp Up Rate	3-4 °C/sec	3-4 °C/sec
Activation Time and Temperature	60-120 sec @ 140-160 °C	60-180 sec @ 170-200 °C
Time Above Melting Point	60-150 sec	60-150 sec
Max Peak Temperature	240 °C	265 °C
Time Within 5 °C of Peak	10-20 sec	10-20 sec
Ramp Down Rate	4-6 °C/sec	4-6 °C/sec

Factory Automation and Identification

Mimix Designator	Package Type	Number of leads offered	W Tape Width	P ₁ Component Pitch	P ₀ Hole Pitch	Reel Diameter	Units per Reel
-QT	QFN (3x3mm)	16	12mm	8mm	4mm	329mm (13in)	2000

Component Orientation: Parts are to be oriented with the PIN 1 closest to the tape's round sprocket holes on the tape's trailing edge.

Note: Tape and Reel packaging is ordered with a -Q00T suffix. Package is available in 500 unit reels through designated sales channels. Minimum order quantities should be discussed with your local sales representative.

Mimix Lead-Free RoHS Compliant Program - Mimix has an active program in place to meet customer and governmental requirements for eliminating lead (Pb) and other environmentally hazardous materials from our products. All Mimix RoHS compliant components are form, fit and functional replacements for their non-RoHS equivalents. Lead plating of our RoHS compliant parts is 100% matte tin (Sn) over copper alloy and is backwards compatible with current standard SnPb low-temperature reflow processes as well as higher temperature (260°C reflow) "Pb Free" processes.

Ordering Information

Part Number for Ordering

CMM0511-QT-0G00
CMM0511-QT-0G0T
PB-CMM0511-QT-0000

Description

Matte Tin plated RoHS compliant 3x3 16L QFN surface mount package in bulk quantity
Matte Tin plated RoHS compliant 3x3 16L QFN surface mount package in tape and reel
CMM0511-QT evaluation board



Caution: ESD Sensitive
Appropriate precautions in handling, packaging and testing devices must be observed.

Proper ESD procedures should be followed when handling this device.