

Part No.

**AL-H483SW3C**

Diff No.

4.8 mm

Type : LED Lamps

Package Dimension :

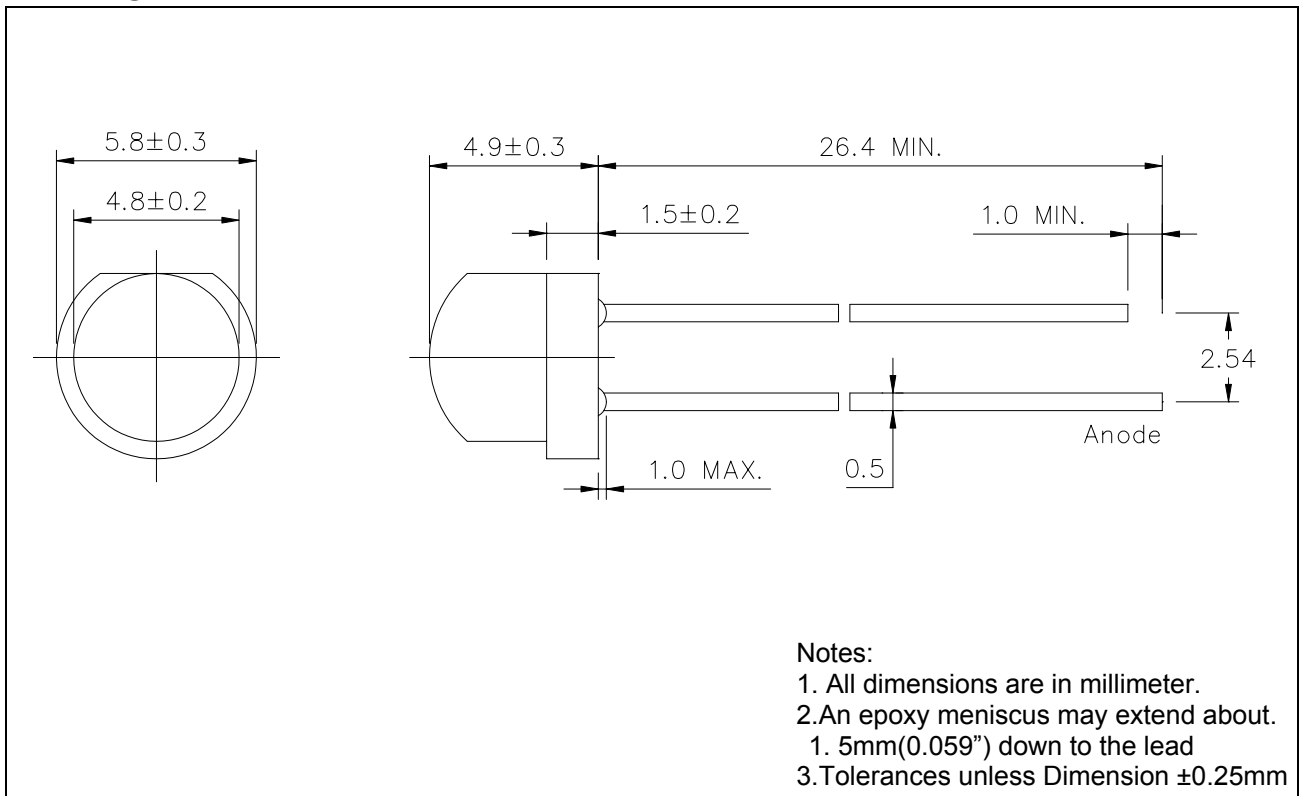

■ Features :

- Choice of various viewing angles.
- Available on Tape and Reel.
- Reliable and robust.

■ Descriptions :

- The series is specially designed for application requiring higher brightness.
- The LED lamps are available with different colors, intensity, epoxy colors etc.

■ Applications :

- TV set
- Monitor
- Telephone

Part No. **AL-H483SW3C**

Diff No.

4.8 mm

Type : LED Lamps

PART NO.	Chip		Lens Color
	Material	Emitted Color	
AL-H483SW3C	InGaN	Sunset White	Water Clear

■ Absolute Maximum Ratings at Ta=25°C

Parameter	Symbol	Rating	Unit
Forward Current	I <sub>F</sub>	20	mA
Operating Temperature	T <sub>opr</sub>	-20 to +85	°C
Storage Temperature	T <sub>stg</sub>	-40 to +100	°C
Soldering Temperature	T <sub>sol</sub>	260 ± 5	°C
Electrostatic Discharge	ESD	1000	V
Power Dissipation	P <sub>D</sub>	100	mW
Peak Forward Current (Duty 1/10@1KHz)	I <sub>F</sub> (Peak)	100	mA
Reverse Voltage	V <sub>R</sub>	5	V

■ Electronic Optical Characteristics :

Parameter	Symbol	Min.	Typ.	Max.	Unit	Condition
Luminous Intensity	I <sub>v</sub>	240	370	/	mcd	I <sub>F</sub> =20mA
Viewing Angle	2θ <sub>1/2</sub>	/	75	/	deg	I <sub>F</sub> =20mA
Chromatically Coordinates	X	/	0.45	/	/	I <sub>F</sub> =20mA
	Y	/	0.41	/		
Forward Voltage	V <sub>F</sub>	/	3.5	4.0	V	I <sub>F</sub> =20mA
Reverse Current	I <sub>R</sub>	/	/	10	μA	V <sub>R</sub> =5V

Part No. **AL-H483SW3C**

Diff No.

4.8 mm

Type : LED Lamps

## ■ Reliability test items and conditions :

NO	Item	Test Conditions	Test Hours/Cycle	Sample Size	Ac/Re
1	Solder Heat	TEMP : 260°C±5°C	5SEC	76PCS	0/1
2	Temperature Cycle	H : +85°C 30min ┆ 5min L : -55°C 30min	50CYCLES	76PCS	0/1
3	Thermal Shock	H : +100°C 5min ┆ 10sec L : -10°C 5min	50CYCLES	76PCS	0/1
4	High Temperature Storage	TEMP : 100°C	1000HRS	76PCS	0/1
5	Low Temperature Storage	TEMP : -55°C	1000HRS	76PCS	0/1
6	DC Operating Life	TEMP : 25°C I <sub>F</sub> =20mA	1000HRS	76PCS	0/1
7	High Temperature / High Humidity	85°C / 85%RH	1000HRS	76PCS	0/1

Part No. **AL-H483SW3C**

Diff No.

4.8 mm

Type : LED Lamps

■ Typical Characteristics (The data typical, and the value is not guaranteed.)

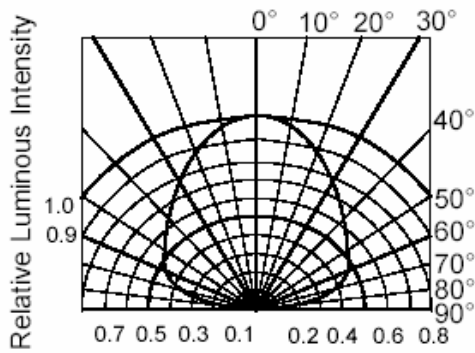

**RADIATION DIAGRAM**

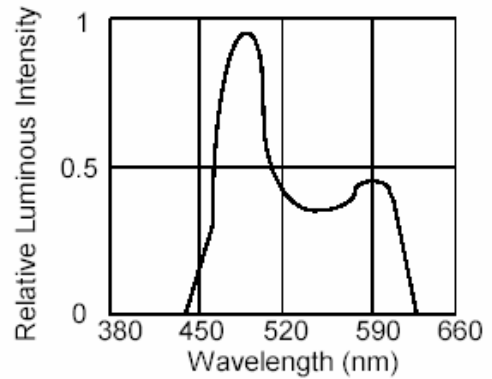

**RELATIVE LUMINOUS INTENSITY Vs. WAVELENGTH**

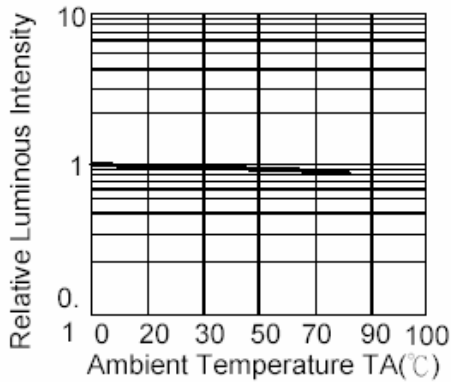

**LUMINOUS INTENSITY Vs. AMBIENT TEMPERATURE**

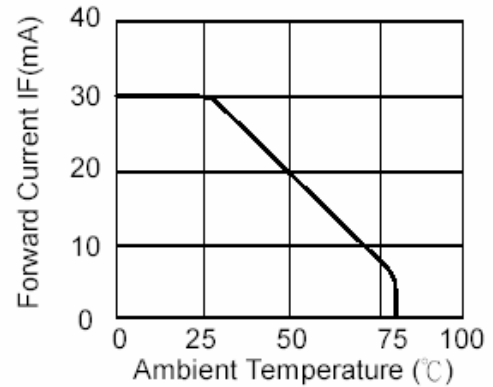

**FORWARD CURRENT Vs. AMBIENT TEMPERATURE**

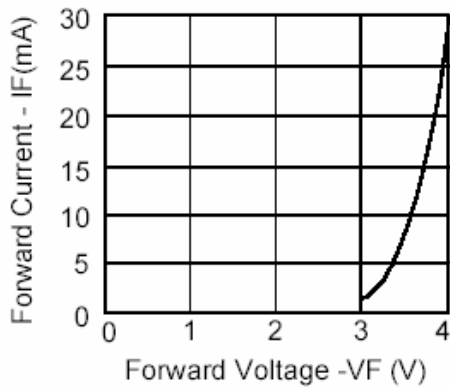

**FORWARD CURRENT Vs. FORWARD VOLTAGE**

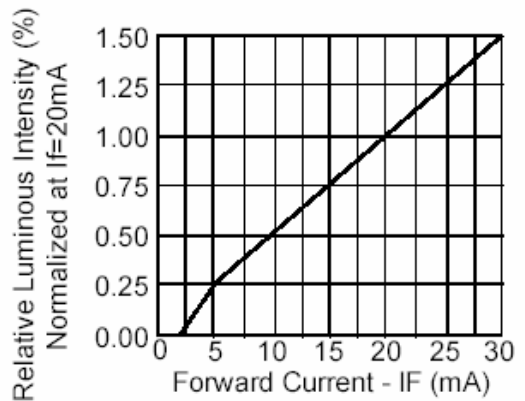

**LUMINOUS INTENSITY Vs. FORWARD CURRENT**