

Part Number: PDC54-11GWA

GREEN

Features

- 0.54 INCH CHARACTER HEIGHT.
- LOW CURRENT OPERATION.
- HIGH CONTRAST AND LIGHT OUTPUT.
- EASY MOUNTING ON P.C. BOARDS OR SOCKETS.
- CATEGORIZED FOR LUMINOUS INTENSITY.
- MECHANICALLY RUGGED.
- STANDARD : GRAY FACE, WHITE SEGMENT.
- RoHS COMPLIANT.

Description

The Green source color devices are made with Gallium Phosphide Green Light Emitting Diode.

Package Dimensions & Internal Circuit Diagram

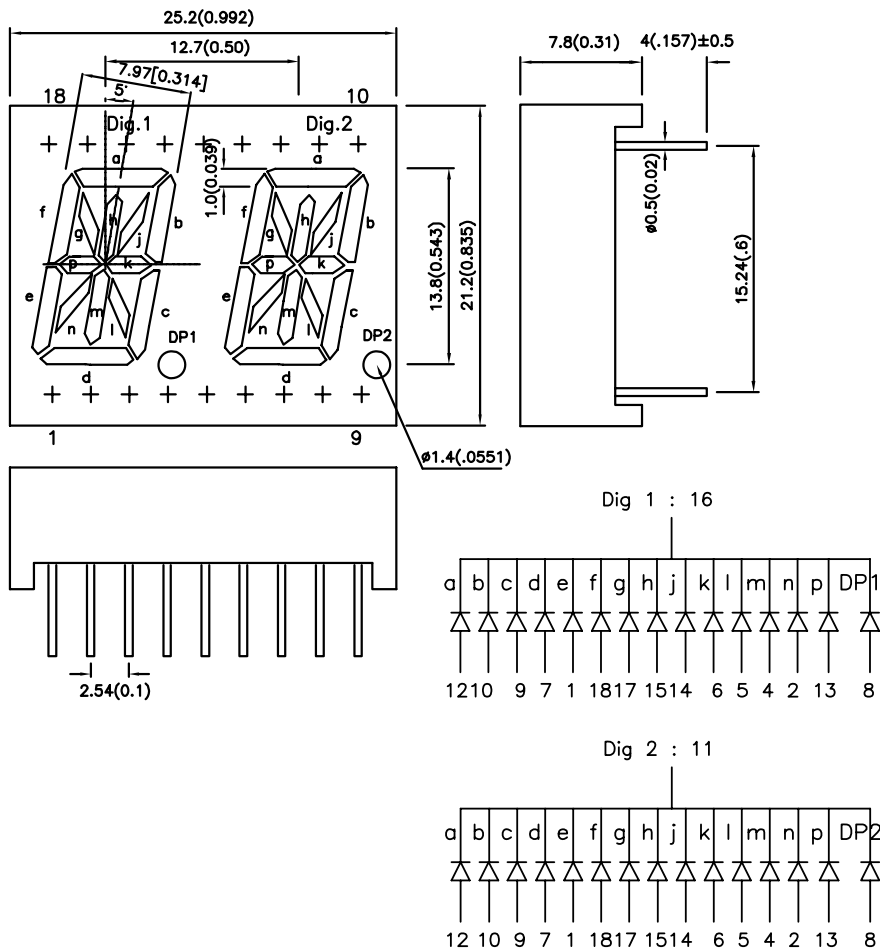

Notes:

1. All dimensions are in millimeters (inches), Tolerance is $\pm 0.25(0.01)$ unless otherwise noted.
2. Specifications are subject to change without notice.

Selection Guide

| Part No. | Dice | Lens Type | Iv (ucd) [1] @ 10mA | | Description |
|-------------|-------------|----------------|------------------------|------|--------------------------------------|
| | | | Min. | Typ. | |
| PDC54-11GWA | GREEN (GaP) | WHITE DIFFUSED | 1900 | 8000 | Common Cathode ,Rt. Hand Decimal. |

Note:

1. Luminous Intensity/ Luminous Flux: +/-15%.

Electrical / Optical Characteristics at TA=25°C

| Symbol | Parameter | Device | Typ. | Max. | Units | Test Conditions |
|-----------------------|--------------------------|--------|------|------|-------|-----------------|
| λ_{peak} | Peak Wavelength | Green | 565 | | nm | IF=20mA |
| λ_D [1] | Dominant Wavelength | Green | 568 | | nm | IF=20mA |
| $\Delta\lambda_{1/2}$ | Spectral Line Half-width | Green | 30 | | nm | IF=20mA |
| C | Capacitance | Green | 15 | | pF | VF=0V;f=1MHz |
| VF [2] | Forward Voltage | Green | 2.2 | 2.5 | V | IF=20mA |
| IR | Reverse Current | Green | | 10 | uA | VR = 5V |

Notes:

1. Wavelength: +/-1nm.

2. Forward Voltage: +/-0.1V.

Absolute Maximum Ratings at TA=25°C

| Parameter | Green | Units |
|-------------------------------|---------------------|-------|
| Power dissipation | 105 | mW |
| DC Forward Current | 25 | mA |
| Peak Forward Current [1] | 140 | mA |
| Reverse Voltage | 5 | V |
| Operating/Storage Temperature | -40°C To +85°C | |
| Lead Solder Temperature [2] | 260°C For 3 Seconds | |

Notes:

1. 1/10 Duty Cycle, 0.1ms Pulse Width.

2. 2mm below package base.

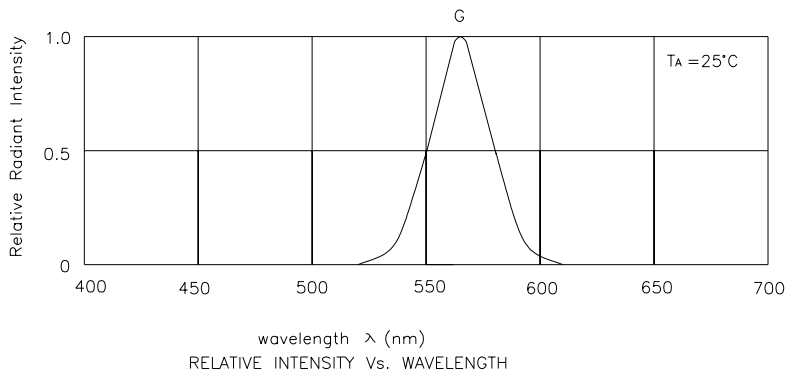

Green

PDC54-11GWA

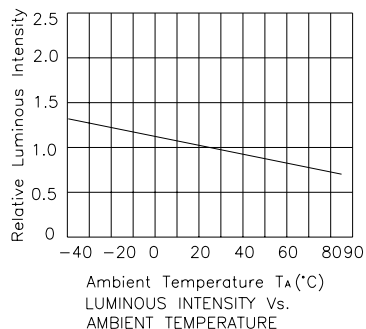
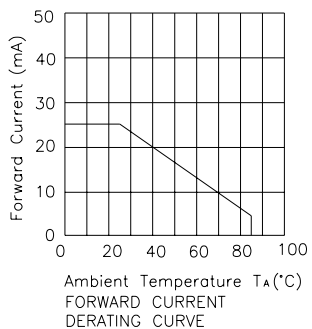
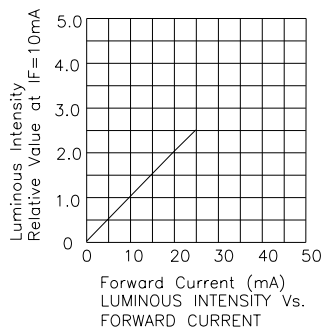
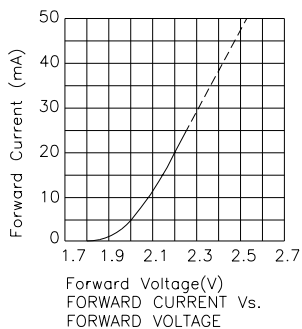

PACKING & LABEL SPECIFICATIONS

PDC54-11GWA

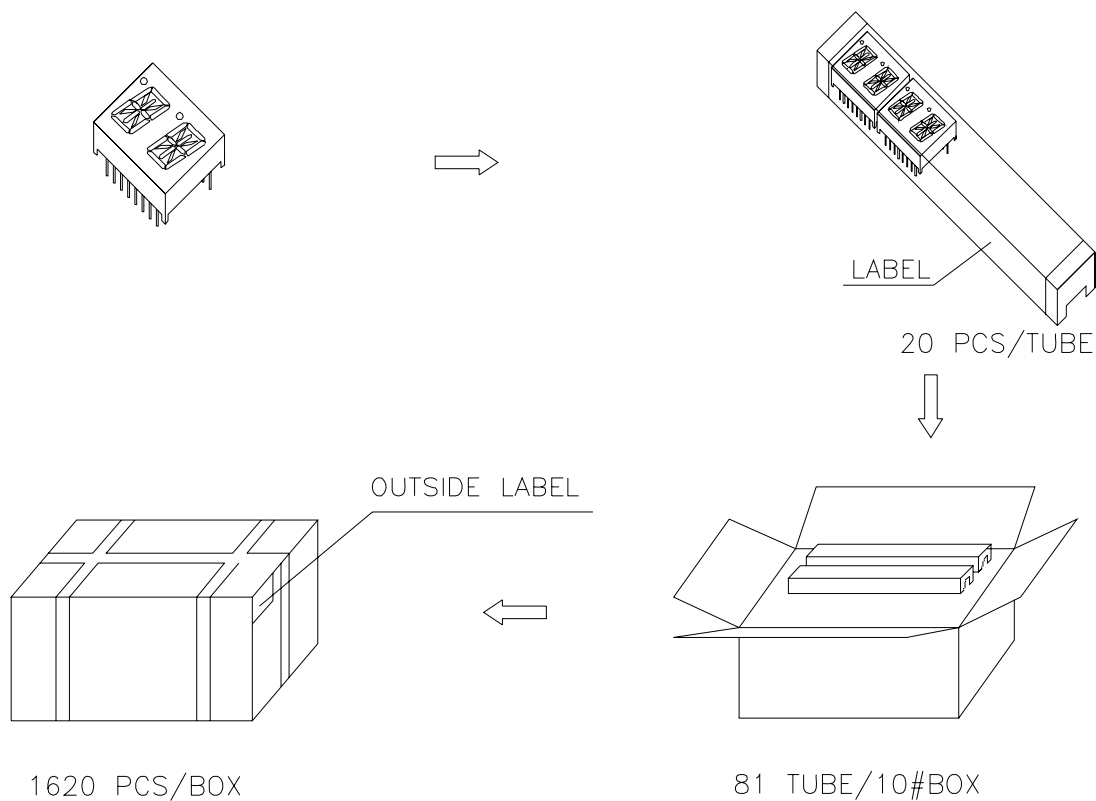

Inside LABEL Paste On The IC-tube

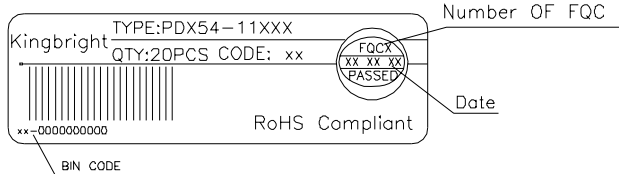

Outside LABEL Paste On The Box

