

***Centauri II (APC12) Non-Isolated DC/DC Power Module
Tiny SMT Footprint – 1.8V-12V Input, 0.9V to 3.6V Output***

PRELIMINARY

The APC12 Centauri II series is Astec’s recent addition to its non-isolated SMT POL line. With the wide acceptance of it’s predecessor (APC08 series) and the continuous system requirement for higher load current, the Centauri platform have been revolutionized to provide 12A load current from it’s original 8A device. The APC12 offers the same standard features common to the Centauri Product Line: wide input voltage range; wide output voltage range; high efficiency; Positive Output Enable; Power Good signal and Current Sharing. It also adapts the same Centauri SMT footprint for optimum user flexibility and multiple sourcing.

The APC12 also comes with an output Trim pin, which allows output adjustment from 0.9V to 3.6V through external resistance programming. It works from a wide input voltage range of 1.8V to 13V and offers an extensive array of output voltages starting from 0.9V to 3.6V. It is ideal for Point of Load applications and provides the most flexibility for the ever-changing DSP and ASIC power requirements.

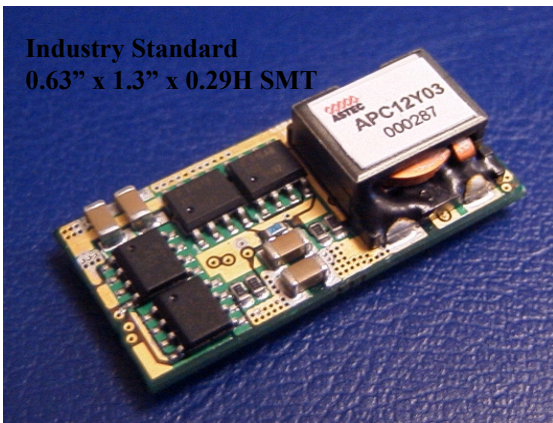

Industry Standard
0.63" x 1.3" x 0.29H SMT

Electrical Parameters

Input

Input range	1.8-6.0VDC and 6.0-13.0VDC
Input Surge	14V
Efficiency	3.3V @ 93.4% (Typical @ 10A) 92.3% (Typical @ 12A)

Control

Enable TTL compatible (Positive Logic)

Output

Regulation (Line, Load, Temp)	<3%
Ripple and noise	75mV - ($\geq 2.5V$ Output) 50mV - ($< 2.5V$ Output)
Output voltage adjust range	0.9V to 3.6V (J Version)
Transient Response	typical 5% deviation with 50% to 75% step load 200 μ S recovery

Special Features

- Point of Load (POL) applications
- High efficiency, 3.3V@94% (25%-75% Load)
- Open Frame SMT
- Remote On/Off (Positive Enable)
- Low output ripple and noise
- Regulation to zero load
- Programmable Output from 0.9V to 3.6V
- Fixed frequency switching (200 KHz)
- Power Good Signal (Optional)
- Active Current share (Optional)

Environmental Specifications

- Operating temperature: -40°C to +85°C
- Storage temperature: -40°C to +125°C
- MTBF: >1 million hours

Safety

Designed to meet:
UL, cUL 60950 Recognized (Pending)
TUV EN60950 Licensed (Pending)



Technical Reference Notes APC12 Centauri II



APC12 Centauri II SERIES
THIS SPECIFICATION COVERS THE REQUIREMENTS
For A New 1.3" X 0.63" X 0.38"(H), 12A Single Output High Efficiency Non-Isolated SMT DC-DC Converter

MODEL NAME		Vin nominal/ Vin range	Vout/Iout
APC12J03	Base Model	3.3V / 1.8-6.0V	0.9V, 12A
APC12J03-9 ¹	With output trim	3.3V / 1.8-6.0V	0.9V, 12A
APC12K03	Base Model	3.3V / 1.8-6.0V	1.2V, 12A
APC12M03	Base Model	3.3V / 1.8-6.0V	1.5V, 12A
APC12Y03	Base Model	3.3V / 2.2-6.0V	1.8V, 12A
APC12G03	Base Model	3.3V / 3.0-6.0V	2.5V, 12A
APC12F03	Base Model	5.0V / 4.2-6.0V	3.3V, 12A
APC12J08	Base Model	8V / 5.6-13.0V	0.9V, 12A
APC12J08-9 ¹	With output trim	8V / 5.6-13.0V	0.9V, 12A
APC12K08	Base Model	8V / 5.6-13.0V	1.2V, 12A
APC12M08	Base Model	8V / 5.6-13.0V	1.5V, 12A
APC12Y08	Base Model	8V / 5.6-13.0V	1.8V, 12A
APC12G08	Base Model	8V / 5.6-13.0V	2.5V, 12A
APC12F08	Base Model	8V / 6.0-13.0V	3.3V, 12A

- Notes:
1. "J" (0.9V) version has a stand alone Output Trim Option (suffix "-9")
 2. Options (suffix):
 - "-9MA" = Trim with Power Good and Active Current Share
 - "-J" = Tray packaging



Technical Reference Notes APC12 Centauri II



Electrical Specifications

STANDARD TEST CONDITION on a single unit, unless otherwise specified.

T _A :	25°C (Ambient Air)
Forced Airflow	200LFM minimum
V _{IN} (P1):	Nominal input (refer to Table in sheet 2)
Enable (P5):	Open
V _O (P2):	Connect to load
Gnd (P3):	Return for V _{in} and V _O
Trim (P4):	Open
PGood (P6):	Open
P (P7):	Open

ABSOLUTE MAXIMUM RATINGS

Stresses in excess of the absolute maximum ratings can cause permanent damage to the device. Functional operation of the device is not implied at these or in any other conditions in excess of those given in the operational sections of the specs. Exposure to absolute maximum ratings for extended periods can adversely affect device reliability.

Parameter	Device	Symbol	Min	Typ	Max	Unit
Input Voltage						
Continuous	03	V _{IN}	1.8	-	6.0	Vdc
Transient (100ms)	03	V _{IN,trans}	-	-	7.0	Vdc
Continuous	08	V _{IN}	5.6	-	13.0	Vdc
Transient (100ms)	08	V _{IN,trans}	-	-	14.0	Vdc
Operating Temperature	All	T _A	-40	-	85	°C
Storage Temperature	All	T _{STG}	-40	-	125	°C
Operating Humidity	All	-	-	-	85	%

INPUT SPECIFICATIONS

Parameter	Device	Symbol	Min	Typ	Max	Unit
Operating Input Voltage ¹	03	V _{IN}	1.8	3.3	6.0	Vdc
	08		5.6	8.0	13.0	Vdc
	APC12F08		6.0	8.0	13.0	Vdc
Maximum Input Current ² (V _{IN} = 0 to V _{IN,max} ; I _O = I _{O,max})	All	I _{IN,max}	-	-	14.0	A
Input Ripple Current 5Hz to 20MHz	All	I _{IN-1}	-	250	300	mAp-p

Note: 1. Minimum V_{IN} (03 device) for 1V8, 2V5 and 3V3 versions are 2V2, 3V and 4.2V respectively. Minimum V_{IN} (08 device) for 3V3 is 6.0V.

2. This power module is not internally fused. The use of an input line fuse is recommended.



Technical Reference Notes APC12 Centauri II



Electrical Specifications *(continued)*

OUTPUT SPECIFICATIONS

Parameter	Device	Symbol	Min	Typ	Max	Unit
Output Voltage Setpoint	0.9V	$V_{O,SET}$	0.873	0.900	0.927	Vdc
$V_{IN} = V_{IN, min}$ to $V_{IN, max}$ at $I_O = I_{O, max}$	1.2V	$V_{O,SET}$	1.164	1.200	1.236	Vdc
	1.5V	$V_{O,SET}$	1.455	1.500	1.545	Vdc
	1.8V	$V_{O,SET}$	1.746	1.800	1.854	Vdc
	2.5V	$V_{O,SET}$	2.425	2.500	2.575	Vdc
	3.3V	$V_{O,SET}$	3.200	3.300	3.400	Vdc
	Output Regulation					
Line: $V_{IN} = V_{IN, min}$ to $V_{IN, max}$	All	-	-	-	0.5	%
Load: $I_O = I_{O, min}$ to $I_{O, max}$		-	-	-	1.0	%
Temp: $T_A = -40\text{ }^\circ\text{C}$ to $+85\text{ }^\circ\text{C}$		-	-	-	± 1.5	%
Output Ripple and Noise ³						
Peak-to-Peak: 5 Hz to 20 MHz	$\geq 2.5V$	-	-	-	75	mV _{PK-PK}
	$< 2.5V$	-	-	-	50	mV _{PK-PK}
Output Current	All	I_O	0	-	12	A
	3V3		0	-	12	A
External Load Capacitance	All	-	-	-	3000	μF
Capacitor ESR		-	-	-	100	m Ω
Output Current-limit Inception ⁴	All	I_O	-	20	-	A
Output Short-circuit Current ⁵	All	-	-	-	-	-
Efficiency	J03	η	73	76	79	%
$V_{IN} = 1.8V$ to $6V^1$ $I_O = 12A$ Resistive Load	K03	η	80	81	84	%
	M03	η	83	86	89	%
	Y03	η	86	87	90	%
	G03	η	88	90	93	%
	F03	η	90	92	94	%
$V_{IN} = 5.6V$ to $13V^1$ $I_O = 12A$ Resistive Load	J08	η	71	73	74	%
	K08	η	75	77	79	%
	M08	η	79	81	83	%
	Y08	η	80	82	84	%
	G08	η	85	87	89	%
	F08	η	88	90	91	%
Switching Frequency	All				200	kHz
Turn-On Time (Input to Output) ⁶	All	-	-	-	65	ms
$I_O = I_{O, max}$; $V_{IN} = V_{IN, nom}$						



Technical Reference Notes APC12 Centauri II



Electrical Specifications *(continued)*

OUTPUT SPECIFICATIONS *(continued)*

Parameter	Device	Symbol	Min	Typ	Max	Unit
Dynamic Response:						
Slew Rate	All	$\Delta I_O/\Delta t$	-	0.1	-	A/ μ s
Load Change: 50% - 75% $I_{O,max}$	All	-	-	5	10	% V_O
Peak Deviation Settling Time to $V_{O,nom}$	All	-	-	100	200	μ s
Load Change: 50% - 25% $I_{O,max}$	All	-	-	5	10	% V_O
Peak Deviation Settling Time to $V_{O,nom}$	All	-	-	100	200	μ s
Output Voltage Overshoot Passive Resistive Full Load	All	-	-	5	-	% V_O

- Note:**
3. Ripple specs are specified at 56 μ F decoupling capacitance for 03 devices and 100 μ F for 08 devices.
 4. This feature is only for module protection and is not intended for customer application. The value is specified at 25°C ambient air temperature. Operation outside the power-derating curve may result to an OCP.
 5. Pulse train with 90ms period and 1 ms pulse width. Average I_{OUT} equals about zero.
 6. Input to Output Turn-on time is defined as the difference between t1 and t2: where t1 is the time when the input voltage reaches the minimum V_{IN} ($V_{IN} = V_{IN,min}$) and t2 is the time when the output voltage reaches its specified range ($V_O = V_{O,SET-MIN}$).

FEATURE SPECIFICATION

Parameter	Device	Symbol	Min	Typ	Max	Unit
Output Voltage Adjustment Range ⁷	-9 opt	-	V_O	-	3.6	V
	-9MA opt	-	V_O	-	3.6	V
Module Parallel Capability $V_{IN} = V_{IN,min}$ to $V_{IN,max}$ at $I_{O-TOT} = (I_{O,max})/(60\%)$ Current Sharing to be within:	-9MA opt	-	40	-	60	% I_{O-TOT}
Power Good ⁸						
Open Collector: max sink current	All		-	-	5	mA
max pull-up voltage	All		-	-	6	V
Output Enable ⁹						
Open Collector TTL compatible						
Module ON: Logic High	All		4.1	-	14	Vdc
Module OFF: Logic Low	All		0	-	0.8	Vdc
Collector Current	All		-	-	60	μ A

- Note:**
7. Single resistor adjustment or single resistor plus a voltage source adjustment. Refer to sheet 9 for recommendations on how to trim the output voltage.
 8. Refer to Figure 6 for the PGood configuration.
 9. Refer to Figure 3 for the Output Voltage Enable configuration.



Technical Reference Notes
APC12 Centauri II



Electrical Specifications *(continued)*

ISOLATION SPECIFICATION

- The APC12 series are Non-Isolated units.

SAFETY APPROVAL

- UL / cUL 60950, and TUV EN60950 - Flammability and temp rise only.

Basic Operation and Features

The APC08/12 Centauri family was designed specifically to address applications where on board distributed power with Point-of-Load Converters (Conversion needed as close to the IC, usually DSP's and ASIC's) is employed. With its wide range input and flexible programmable output, any change in the load becomes very manageable with little to no impact on time to market. All of the converters in this family are buck converters. The APC12x03 versions allow 1.8V to 6V input voltage and the APC12x08 versions allow a 5.6V to 13V input with 14V max surge.

MODULE PIN ASSIGNMENT

There are 4 to 7 surface mount pins on a Centauri module. The availability of pins from individual modules is relevant to its version / selected option.

PIN #	DESIGNATION	
P1	V_{IN}	Input Voltage
P2	V_O	Output Voltage
P3	GND	Common Ground
P4	TRIM	Output Voltage Adjustment [OPTION]
P5	ENABLE	Output Voltage Enable
P6	PGood	Power Good [OPTION]
P7	P	Load Current Active Sharing [OPTION]

INDUSTRY STANDARD PINOUT

When ordered with no options, the module comes with only 4 pins – V_{IN} , Gnd, V_{OUT} and Enable – AND IS COMPATIBLE WITH OTHER LEADING MANUFACTURER'S FOOTPRINT. When the full-featured module is required: with Output Trim; Active Current Share and Power Good Signal PINs, "-9MA" suffix is added to the standard part number. Please refer to the Part Number Ordering Scheme for other options (including packaging).

Note: When using the trim function, this module offers much more trim flexibility than the competitive footprint and also requires a jumper between the two footprints to be source compatible. Contact Factory for details.

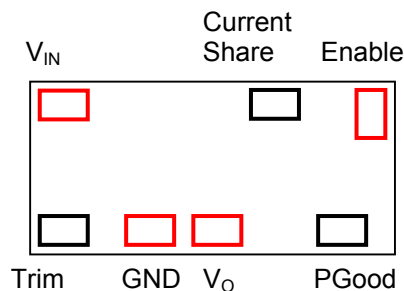

Figure 1. Pin Assignment Viewed from Top of Board.

Typical Application Circuit (Standard Pinout)

Recommended C1 is a low ESR (<100 mΩ) 330 μF tantalum and C2 is a 1 μF ceramic or equivalent. Recommended output-decoupling capacitor C3 is 56 μF (less than 75 mΩ ESR) for APC12x03 devices and 100μF (less than 40 mΩ ESR) for APC12x08 devices.

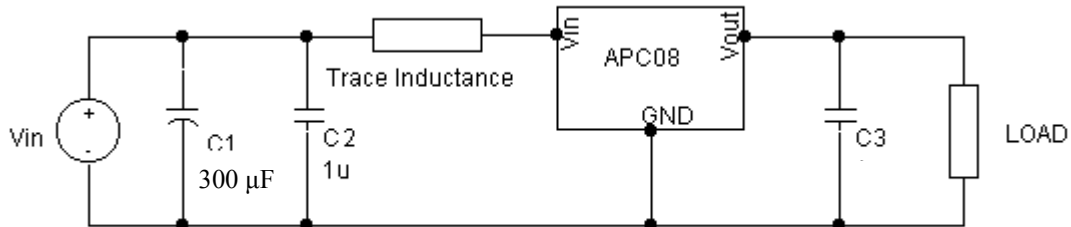

Figure 2a. Typical Application Circuit.

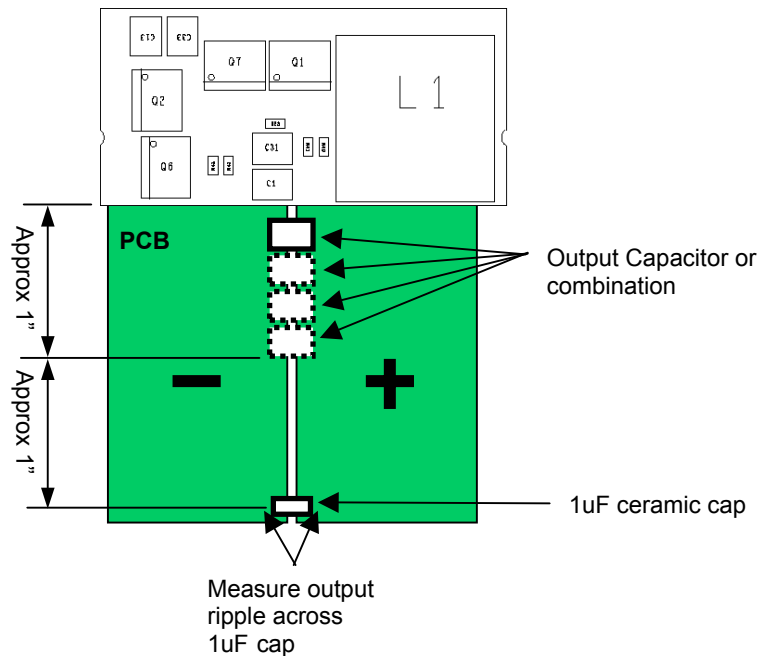

Figure 2b. Ripple Measurement Setup.

Enable Pin (Standard configuration)

Pin P5 is functioned to enable the output voltage of a module. If this pin is left open or connected to $\geq 4.1\text{Vdc}$, the module is turned on. On the other hand, if this pin is connected to ground or to a voltage potential from 0 to 0.8Vdc , the module is turned off. The enable pin can source current up to $60\mu\text{A}$ max - suited for typical open-collector transistors readily available in the market.

For TTL compatibility, Figure 3 shows a 7405 open collector inverter IC utilized to function the Enable feature. Other common chips that can do the function are 74S05; 74HCT05; non-inverting - 7407; 74S07; 74HC07. If SMT packaging is preferred, Fairchild's Tiny Logic NC7SZ05 or TI's Little Logic SN7SLVC1G06 comes in SOT23 or SC70 packages.

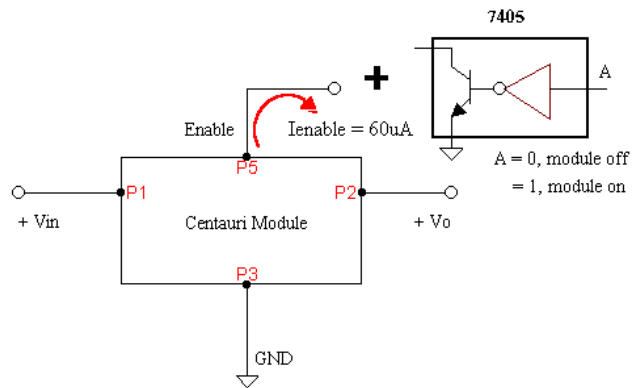

Figure 3. Output Voltage Enable function diagram.

Special Feature Pins (Options):

Trim Function (-9):

Pin P4 is used for output voltage adjustment. The output voltage can be trimmed through an external resistor or through an external DC supply as described in the succeeding sections.

Method 1: External Trim Resistor.

By connecting an external resistor across P4 and P3 (Gnd), the voltage appearing on pin P2 (V_o) is adjusted to a higher value. The output voltage of a module can be adjusted up to a maximum value of 3.3V (nominal) or 83% of the input voltage, whichever is lower. By connecting an external resistor across P4 and P2, V_o is adjusted to a lower value. Only small reductions, 2%, in voltage are recommended, as adjustment to lower voltages tends to affect the loop compensation of the module.

Full range adjustment (from 0.9V to 3.6V) can be obtained from a module with the lowest V_o setpoint ($0.9V_o$).

Trim Function (continued)

To adjust V_o to a higher value, please refer to Figure 4. The required resistor value (R_t) can be determined through Equation (1) where V_o is the voltage on P2 before the adjustment and V_{ot} is the voltage of P2 after R_t is connected.

$$R_t = \frac{V_{ref}}{V_{ot} - V_o} R_1 \quad \text{Equation (1)}$$

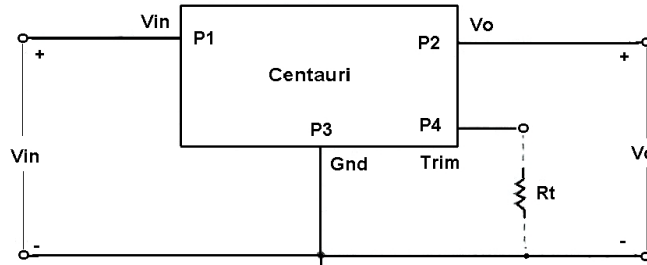

Figure 4. Output Voltage Trim Setup.

Please refer to related constants given in TABLE 1 to calculate the Equation.

TABLE 1. CONSTANTS

	Version	0.9V	1.2V	1.5V	1.8V	2.5V	3.3V	R1
APC08/12x03	R2	97.6k	8.45k	4.32k	2.94k	1.69k	1.13k	3.09k
APC08/12x08	R2	210k	17.4k	9.09k	6.04k	3.48k	2.32k	6.49k
V_{ref}	0.87V							

Be aware that the maximum V_o allowed is 3.6V. Please refer to Centauri datasheet.

Example:

Module version: APC08J03-9 (1.8 to 6.0Vin, 0.9Vo).

Requiring to adjust output voltage from $V_o = 0.9V$ to $V_{ot} = 1.8V$. $V_{ref} = 0.87V$ and $R_1 = 3.09k\Omega$ (from TABLE 1).

Based on Equation (1), R_t can be determined as 3.0kΩ.

To adjust V_o to a lower value, R_t should be connected between P4 and P2. Equation (2) provides the calculation for R_t .

$$R_t = \frac{(V_o - V_{ref})(V_{ot} - V_{ref})}{V_{ref}(V_o - V_{ot})} R_2 \quad \text{Equation (2)}$$

Be aware that the minimum V_o is 0.9V.

Example

Module version: APC08F03-9 (4.0 to 6.Vin, 3.3Vo).

Requiring to adjust the output voltage from $V_o = 3.3V$ to $V_{ot} = 3.3(1-0.02) = 3.234V$.

$V_o = 3.3V$, $V_{ot} = 3.234V$, $V_{ref} = 0.87V$, $R_2 = 1.13k\Omega$ (from TABLE 1).

Based on Equation (1), R_t can be determined as 111.9kΩ.

Trim Function (continued)

Method 2: External DC Source

By connecting an external DC supply across P4 (Enable) and P3 (GND) through a limiting resistor R_t , output voltage adjustment can also be achieved. Equation 3 provides the relationship between the External DC supply, V_t , and V_o (where V_o is the desired output voltage).

$$V_t = \left(1 + \frac{R_t}{R_1} + \frac{R_t}{R_2}\right) V_{ref} - \frac{R_t}{R_1} V_o \quad \text{Equation (3)}$$

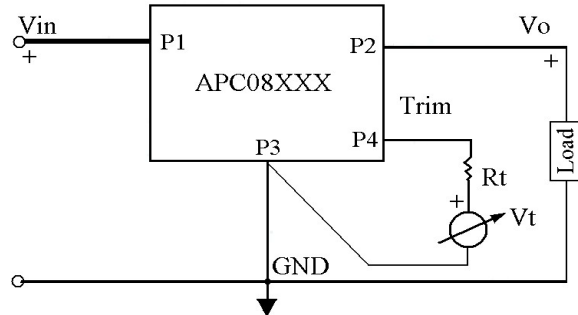

Figure 5. External DC source for output trim adjust.

Given: $R_t = 10k\Omega$

Vo Adjustment to Lower Voltages. This method does not limit the recommended lower V_o adjustment to 2% as mentioned on previous sections re: V_o adjustment through external trim resistor.

Example:

Module version: APC08G03-9 (3V to 6Vin, 2.5Vo).

Requiring to adjust the output voltage from $V_o = 2.5V$ to 1.8V

$V_o = 1.8V$, $V_{ref} = 0.87V$, $R_1 = 3.09k\Omega$, $R_2 = 1.69k\Omega$ (from Table 1). Based on Equation (3), $V_t = 3.0V$.

Example:

Module version: APC08G03-9 (3V to 6Vin, 2.5Vo).

Requiring to adjust the output voltage from $V_o = 2.5V$ to 0.9V

$V_o = 0.9V$, $V_{ref} = 0.87V$, $R_1 = 3.09k\Omega$, $R_2 = 1.69k\Omega$ (from Table 1). Based on Equation (3), $V_t = 5.9V$.

Vo Adjustment to Higher Voltages

Example:

Module version: APC08G03-9 (3V to 6Vin, 2.5Vo).

Requiring to adjust the output voltage from $V_o = 2.5V$ to 3.3V

$V_o = 3.3V$, $V_{ref} = 0.87V$, $R_1 = 3.09k\Omega$, $R_2 = 1.69k\Omega$ (from Table 1). Based on Equation (3), $V_t = -1.84V$.

If application of negative voltage is not desired, the limiting resistor R_t can either be changed to a lower value ($R_t = 1k\Omega$, such that $V_t = 0.60V$ per Equation 3), or use Method 1.

Power Good Signal Operation (Option (-9MA)):

PG pin provides an output signal indicating the Vout is operational (TTL logic signal). It can sink current up to a max of 5mA and can have a maximum external pull-up voltage of 6V. Please see recommended setup shown on Figure 6.

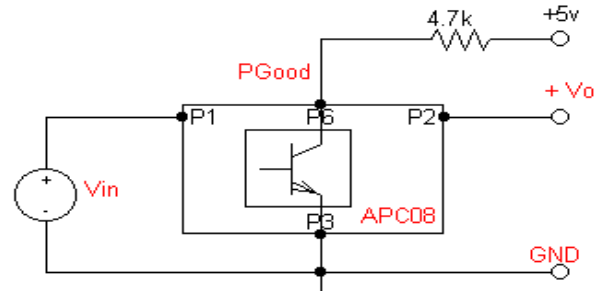

Figure 6. PG Good setup.

Active Current Share Operation (Option (-9MA)):

Active Current share pin is compatible with like modules only (APC08 to APC08 or APC12 to APC12). Connecting this pin directly with the same Pin from another module guarantees current sharing to within 40% to 60% Iout. Note that this pin is not compatible with competitive modules that employ active current sharing.

To attain efficient current sharing between like modules, the following points are recommended:

- a) The modules to be shared should be located as close as possible into the host card.
- b) The copper tracks that connect Vo and GND should at least be 0.60" in width with at least 2 oz. Cu.

Performance Curves – Efficiency

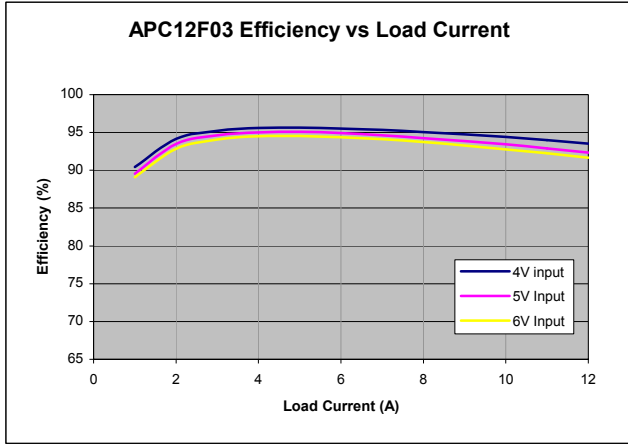

Figure 7. APC08F03 Efficiency Curve.

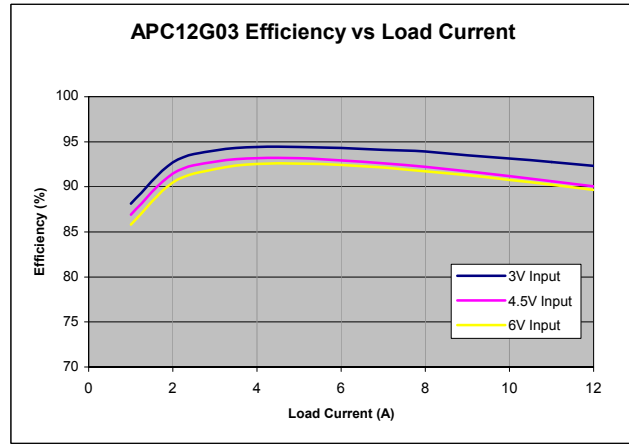

Figure 8. APC08G03 Efficiency Curve.

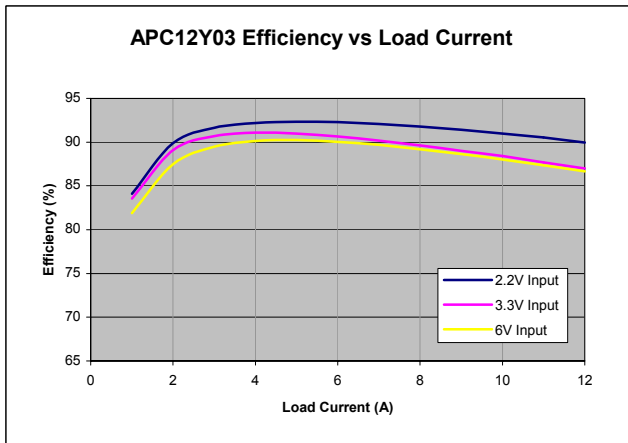

Figure 9. APC08Y03 Efficiency Curve.

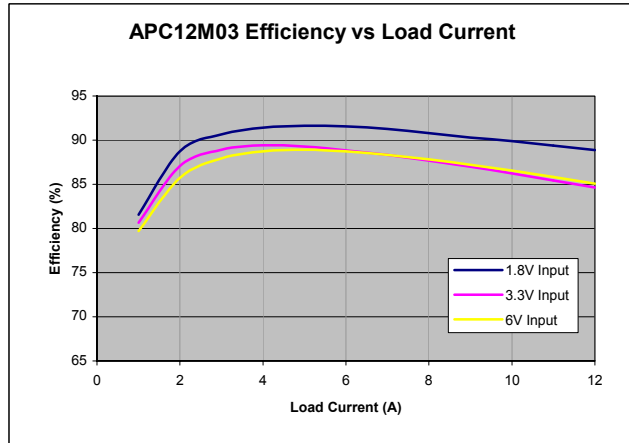

Figure 10. APC08M03 Efficiency Curve.

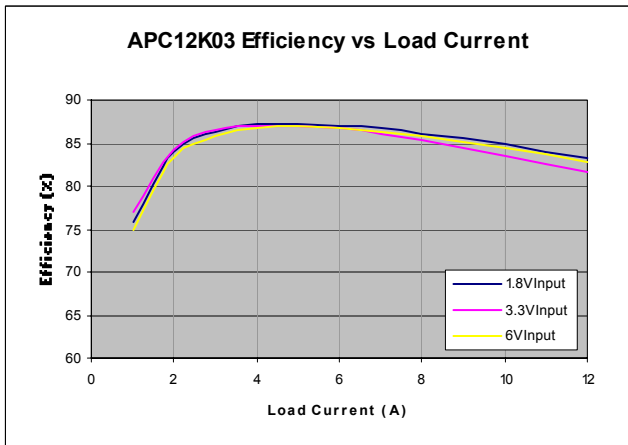

Figure 11. APC08K03 Efficiency Curve.

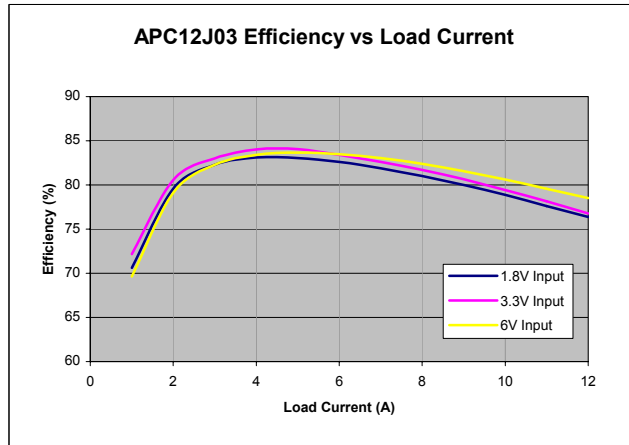

Figure 12. APC08J03 Efficiency Curve.



Performance Curves - Efficiency (continued)

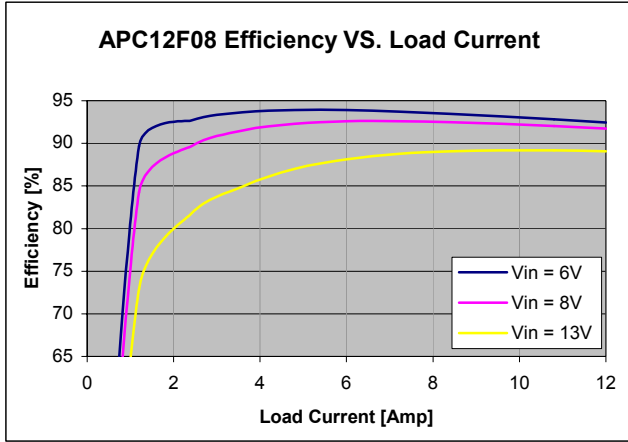

Figure 13. APC12F08 Efficiency Curve.

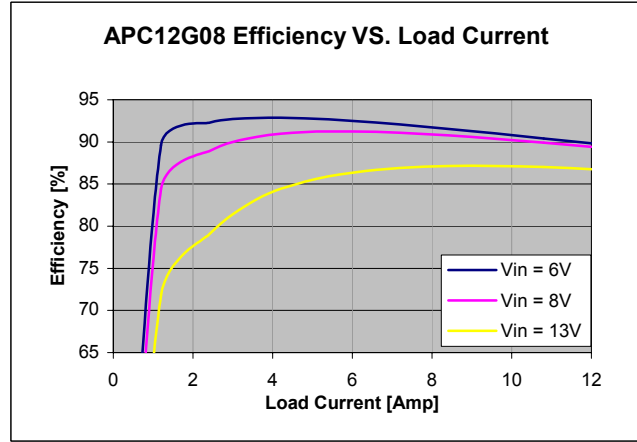

Figure 14. APC12G08 Efficiency Curve.

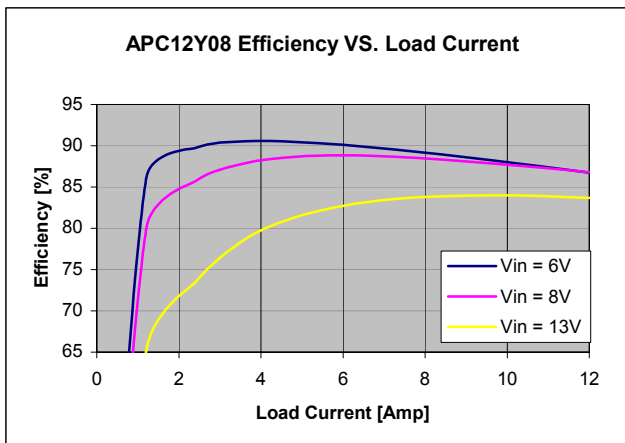

Figure 15. APC12Y08 Efficiency Curve.

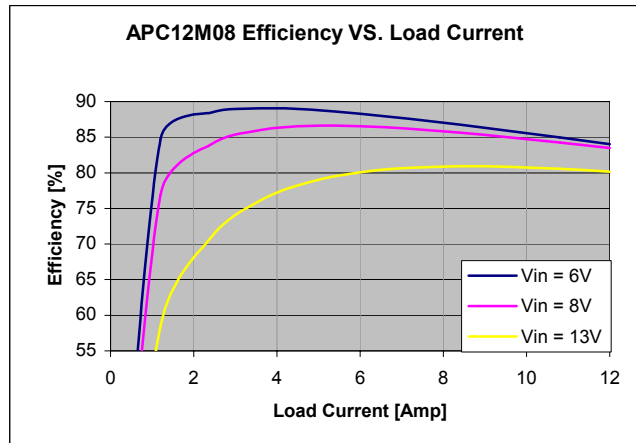

Figure 16. APC12M08 Efficiency Curve.

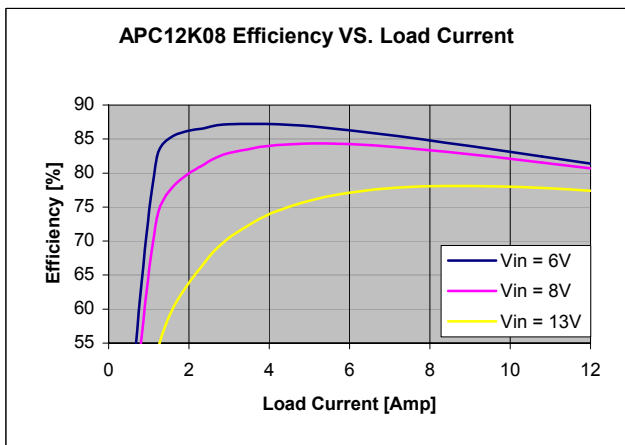

Figure 17. APC12K08 Efficiency Curve.

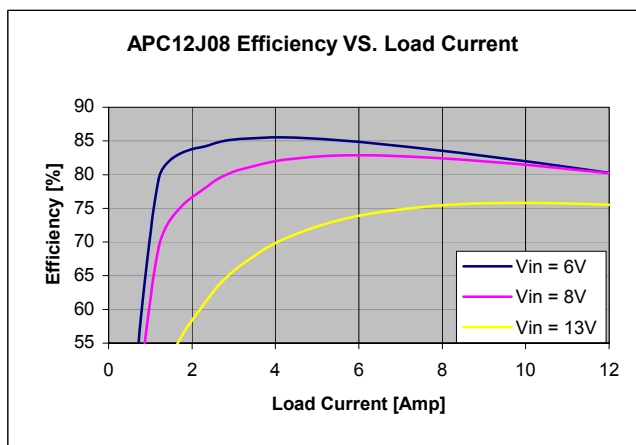

Figure 18. APC12J08 Efficiency Curve.

Performance Curves - Thermal Derating Curve

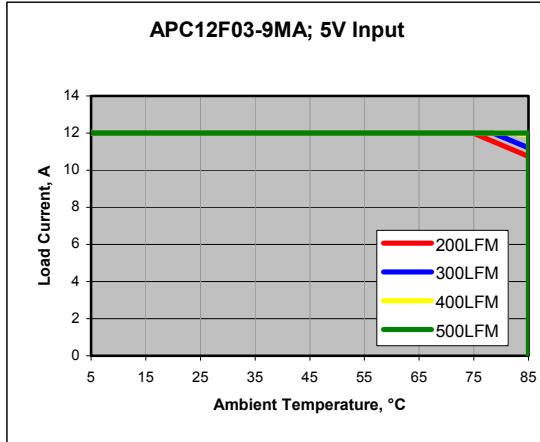

Figure 19. F03 - Load current vs. ambient temp.

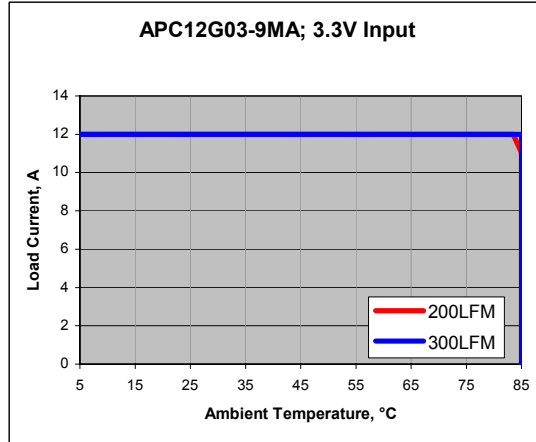

Figure 20. G03 – Load current vs. ambient temp.

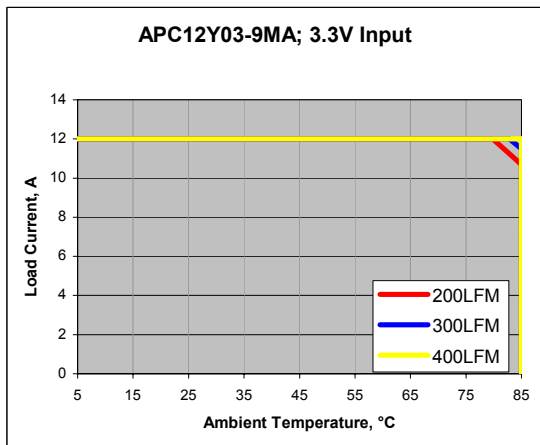

Figure 21. Y03 – Load current vs. ambient temp.

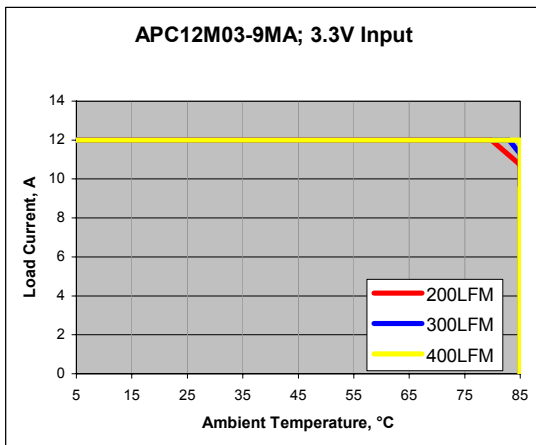

Figure 22. M03 – Load current vs. ambient temp.

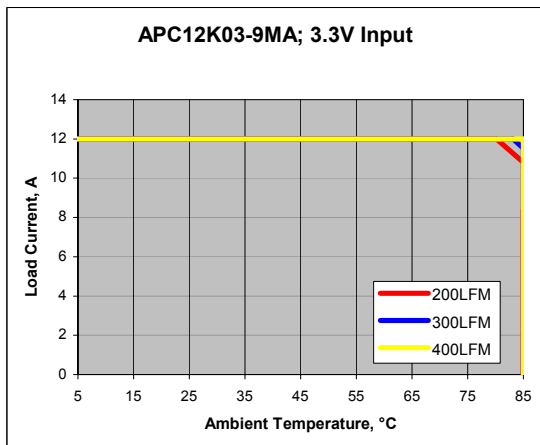

Figure 23. K03 – Load current vs. ambient t temp.

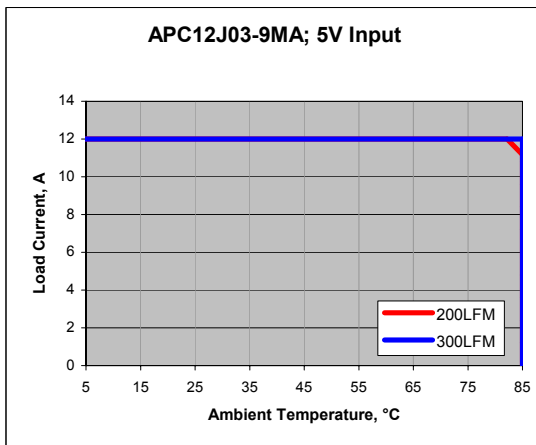

Figure 24. J03 – Load current vs. ambient temp.

Performance Curve - Thermal Derating (continued)

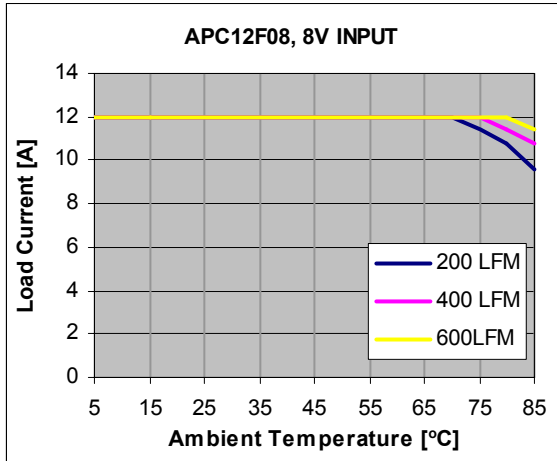

Figure 25. F08 – Load current vs. ambient temp.

Figure 26. G03 – Load current vs. ambient temp.

Figure 27. Y03 – Load current vs. ambient temp.

Figure 28. M03 – Load current vs. ambient temp.

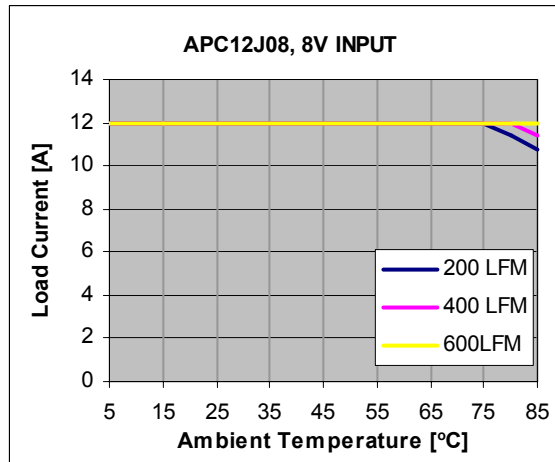

Figure 29. K03 – Load current vs. ambient temp.

Figure 30. J03 – Load current vs. ambient temp.

Performance Curves

APC12F03

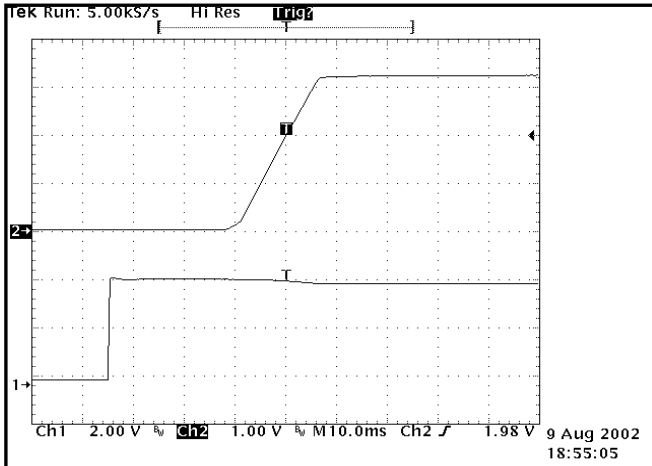

Figure 31. Input to Output Delay at 12A load (CH2 = V_o ; CH1 = Enable Voltage).

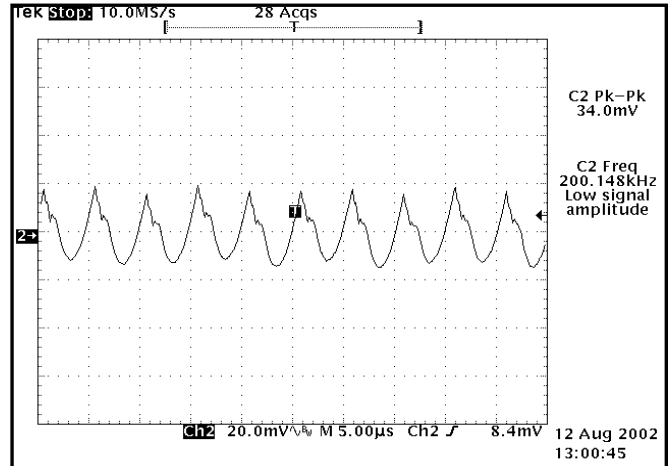

Figure 32. Output Ripple and Noise at 12A; $V_{IN} = 4V$; BW = 20MHz; $T_a = 25^\circ C$.

APC12G03

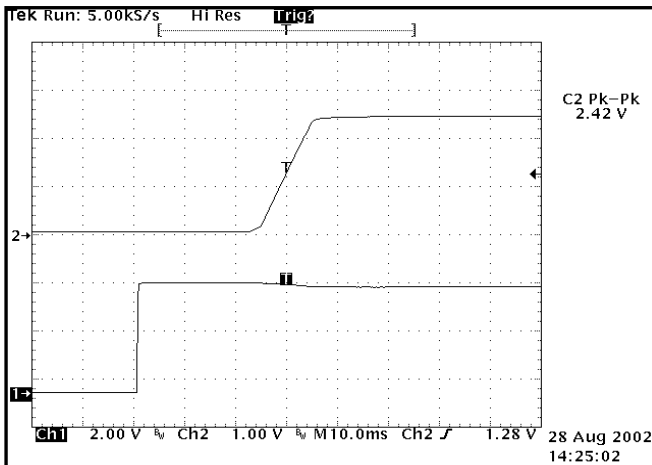

Figure 33. Input to Output Delay at 12A load (CH2 = V_o ; CH1 = Enable Voltage).

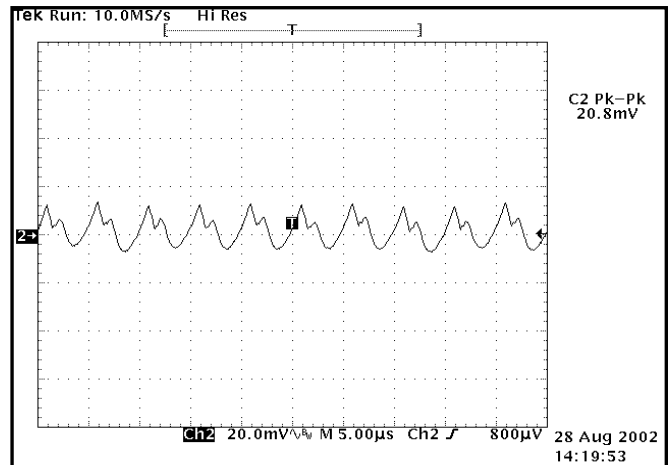

Figure 34. Output Ripple and Noise at 12A; $V_{IN} = 3.0V$; BW = 20MHz; $T_a = 25^\circ C$.

Performance Curves (continued)

APC12Y03

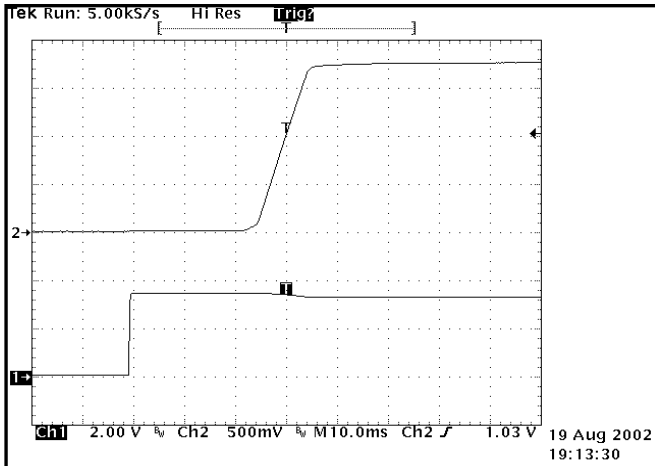

Figure 35. Input to Output Delay at 12A load (CH2 = V_o ; CH1 = Enable Voltage).

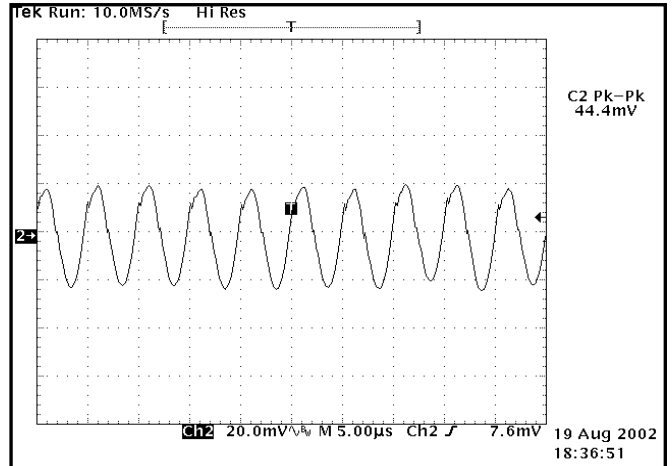

Figure 36. Output Ripple and Noise at 12A; $V_{IN} = 3.3V$; BW = 20MHz; $T_a = 25^\circ C$.

APC12M03

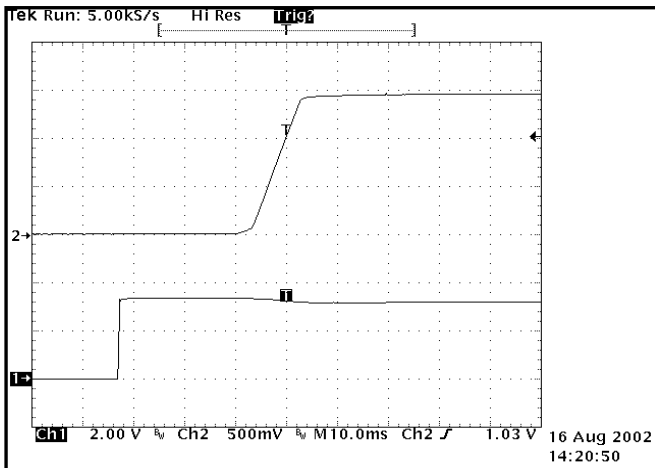

Figure 37. Input to Output Delay at 12A load (CH2 = V_o ; CH1 = Enable Voltage).

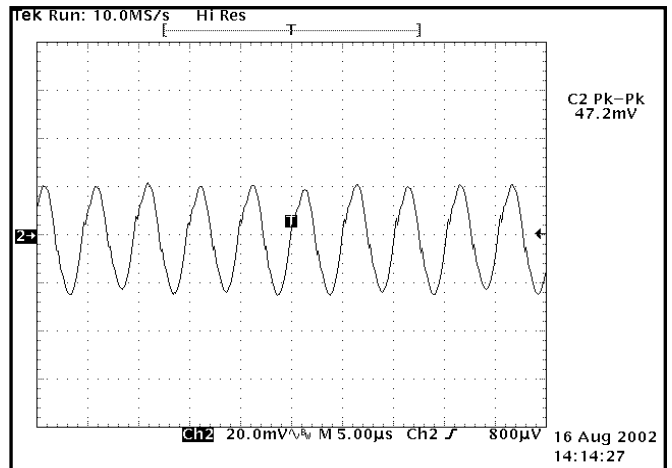

Figure 38. Output Ripple and Noise at 12A; $V_{IN} = 3.3V$; BW = 20MHz; $T_a = 25^\circ C$.

Performance Curves (continued)

APC12K03

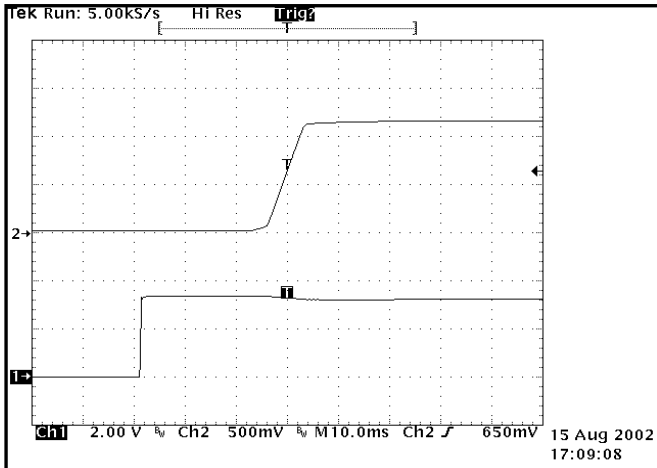

Figure 39. Input to Output Delay at 12A load (CH2 = V_o ; CH1 = Enable Voltage).

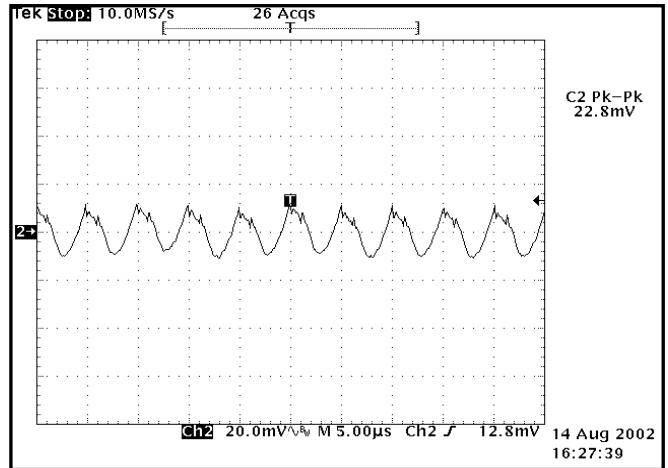

Figure 40. Output Ripple and Noise at 12A; $V_{IN} = 1.8V$; BW = 20MHz; $T_a = 25^\circ C$.

APC12J03

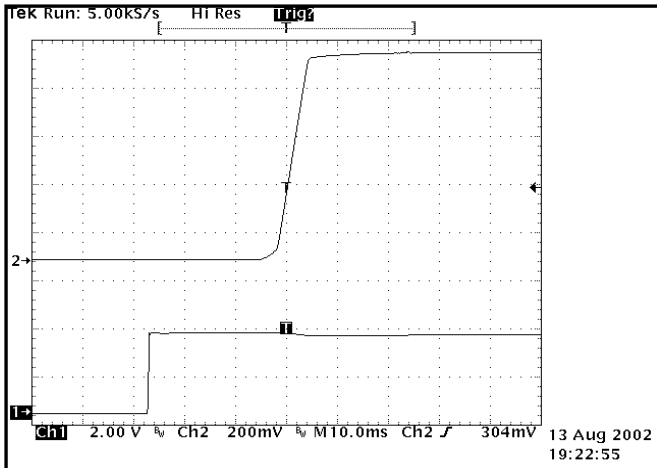

Figure 41. Input to Output Delay at 12A load (CH2 = V_o ; CH1 = Enable Voltage).

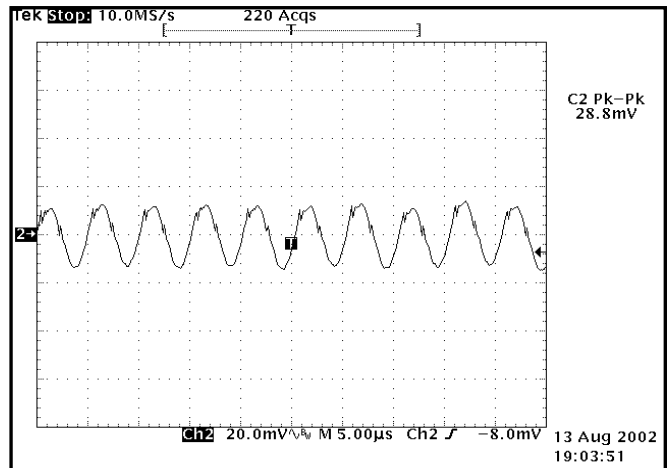
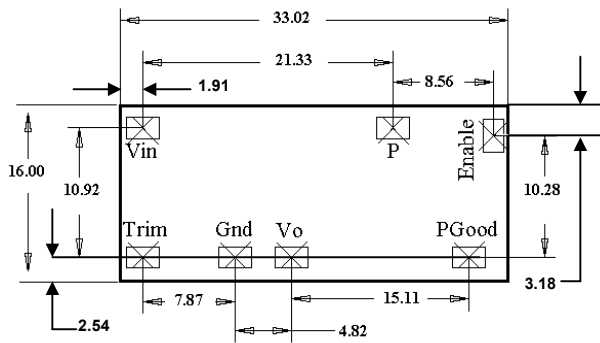

Figure 42. Output Ripple and Noise at 12A; $V_{IN} = 1.8V$; BW = 20MHz; $T_a = 25^\circ C$.

Mechanical Specifications

OUTLINE DRAWING

Parameter	Device	Symbol	Min	Typ	Max	Unit
Dimension	All	L	-	-	1.300 (33.02)	in (mm)
		W	-	-	0.630 (16.00)	in (mm)
		H	-	-	0.370 (9.34)	in (mm)
Weight	All	-	-	5 (0.16)	10 (0.32)	g (oz)



PIN / PIN DIMENSION	
Nominal Pin Dimension	0.055 X 0.102 [in]
Suggested Pad Dimensions	0.070 X 0.110 [in]

Figure 55. Recommended PAD Layout.

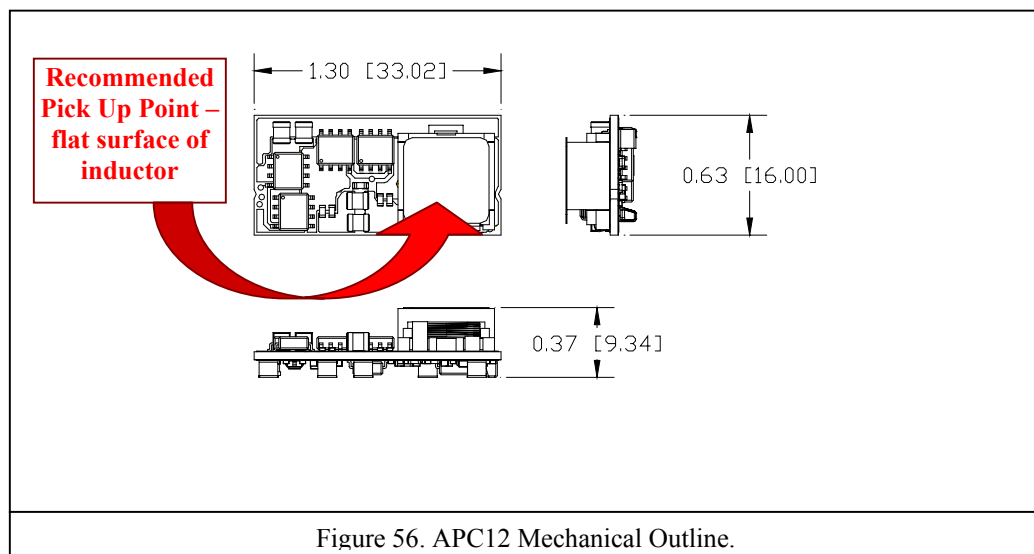

Figure 56. APC12 Mechanical Outline.

Mechanical Specifications (continued)

RECOMMENDED LOCATION FOR PICK AND PLACE

The flat top surface of the large inductor (topside of the board) provides a versatile and convenient way of picking up the module (see Figure 56). A 6-7mm outside diameter nozzle from a conventional SMD machine is recommended to attain maximum vacuum pick-up. Nozzle travel and rotation speed should be controlled to prevent this off-centered picked-up module from falling off the nozzle. The use of vision recognition systems for placement accuracy will be very helpful.

REFLOW NOTES / RECOMMENDATIONS

1. Refer to the recommended Reflow Profile per Figure 57. Profile parameters exceeding the recommended maximums may result to permanent damage to the module.
2. The module is recommended for topside reflow process to the host card. For other orientations, contact factory.
3. In the event that the module needs to be desoldered from the host card, some pins may be detached from the module.

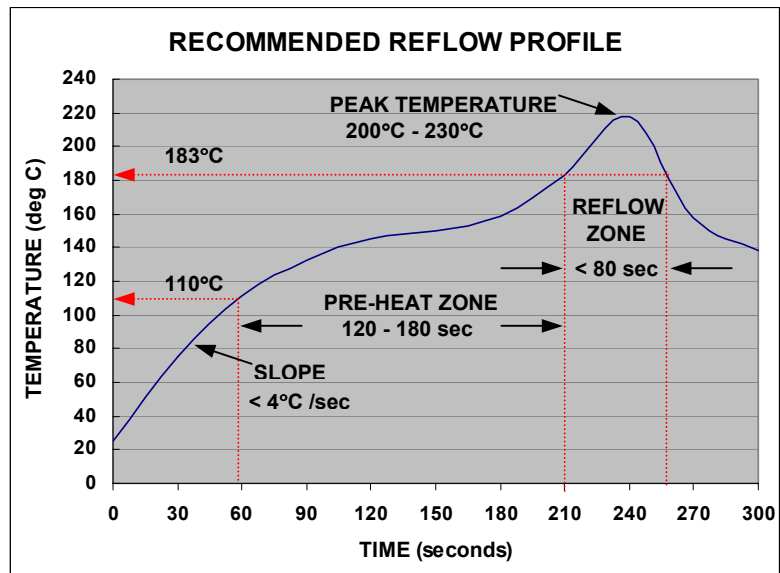

Figure 57. Recommended Reflow Profile.

MODULE MARKINGS / LABELS

Marking shall be permanent and legible. Please refer to Figure 58 for the module marking/ label detail.

Note 1	
MMM	Model No
FFF	Option
Note 2	
YYWW	Year / Work Week
D	Day of Week
PP	nth Panel of the day
LL	Location in the panel
Note 3: Barcode	
	6 & 7 characters / line Code 128, 32CPI 0.070" Height



Figure 58. Module Label



Technical Reference Notes
APC12 Centauri II



Mechanical Specifications *(continued)*

PACKING AND SHIPPING

Standard packaging for the modules will be in tape and reel. Jedec-style tray packaging is also available (add suffix "J" in pn). Please refer to the ordering information. Maximum number of modules in a reel is 250 pcs. The tray can hold 35 modules max. Please refer to Figure 59 for the T&R carrier dimensions and Figure 60 for the tray dimensions.

Figure 59. Tape/ pocket dimensions

Figure 60. Jedec-style tray dimensions in mm.



Technical Reference Notes APC12 Centauri II



PART NUMBER CODING SCHEME FOR ORDERING

A	P	C	1	2	x	0	y	-	z
----------	----------	----------	----------	----------	----------	----------	----------	----------	----------

x	Output Voltage						
	<table> <tr> <td>F = 3.3V</td> <td>M = 1.5V</td> </tr> <tr> <td>G = 2.5V</td> <td>K = 1.2V</td> </tr> <tr> <td>Y = 1.8V</td> <td>J = 0.9V</td> </tr> </table>	F = 3.3V	M = 1.5V	G = 2.5V	K = 1.2V	Y = 1.8V	J = 0.9V
F = 3.3V	M = 1.5V						
G = 2.5V	K = 1.2V						
Y = 1.8V	J = 0.9V						
y	Input Voltage Range						
	<table> <tr> <td>3: 1.8V to 6V</td> </tr> <tr> <td>8: 5V to 12V</td> </tr> </table>	3: 1.8V to 6V	8: 5V to 12V				
3: 1.8V to 6V							
8: 5V to 12V							
z	Options						
	<p>9: Trim function (exist for "J" version only)</p> <p>9MA: Trim function plus PGood and Current Sharing</p> <p>J: Adding a "J" suffix indicates Jedec style tray packaging; No suffix "J" defaults to T&R packaging</p>						

Please call 1-888-41-ASTEC for further inquiries or visit us at www.astecpower.com