

# **A-BRIGHT** A-BRIGHT INDUSTRIAL CO., LTD. SURFACE MOUNT CHIP LED LAMPS

## TFT DISPLAY LED

Part Number: 99-215UWC/TR8

### Package outlines & Re-flow Profile

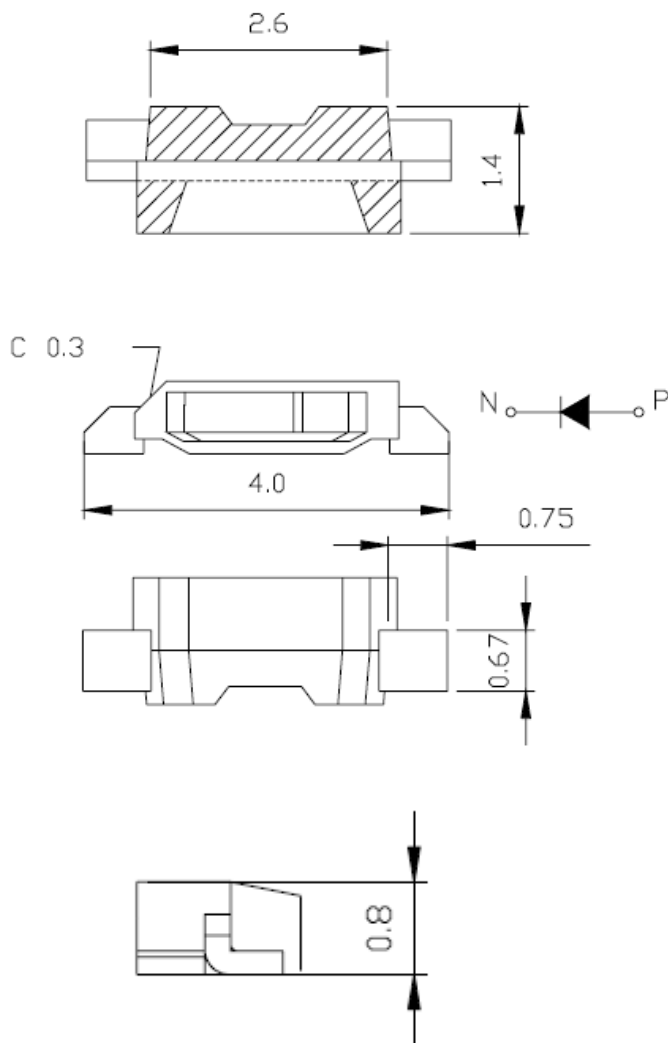

#### ■ Reflow Temp/Time

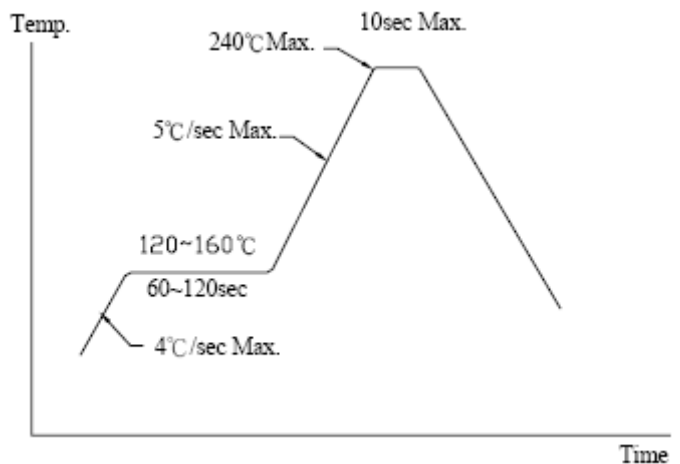

#### ■ Soldering iron

Basic spec is  $\leq 5$ sec when 260°C. If temperature is higher, time should be shorter (+10°C  $\rightarrow$  -1sec). Power dissipation of iron should be smaller than 15W, and temperatures should be controllable. Surface temperature of the device should be under 230°C.

ITEM	MATERIALS
Resin (mold)	Epoxy
Lens color	Yellow Diffused
Printed circuit board	BT
Emitted color	White
Material	InGaN

#### NOTES:

- All dimensions are in millimeters (inches);
- Tolerances are  $\pm 0.1$ mm (0.004inch) unless otherwise noted.
- Polarity referring onto the cathode mark is reversed on the red.

**A-BRIGHT** A-BRIGHT INDUSTRIAL CO., LTD.  
**SURFACE MOUNT CHIP LED LAMPS**

Part Number: 99-215UWC/TR8

**ELECTRO-OPTICAL CHARACTERISTICS** (T<sub>A</sub>=25°C)

Parameter	Test Condition	Symbol	Value			Unit
			MIN.	TYP.	MAX.	
Viewing angle at 50% I <sub>v</sub>	I <sub>F</sub> =10mA	2θ 1/2	115			Deg
Forward voltage	I <sub>F</sub> =20mA	V <sub>F</sub>	---	3.4	3.8	V
Luminous intensity	I <sub>F</sub> =20mA	I <sub>v</sub>	500	1100	---	mcd
Chromaticity	I <sub>F</sub> =20mA	X	---	0.31	---	---
		Y	---	0.32	---	
Peak pulsing current (1/10 duty f=1kHz)		I <sub>FP</sub>	60			mA

**Absolute maximum ratings (SDR)** (T<sub>A</sub>=25°C)

Parameter	Symbol	Value	Unit
Forward current	I <sub>F</sub>	30	mA
Reverse voltage	V <sub>R</sub>	5	V
Reverse current	I <sub>R</sub>	50	μA
Electrostatic Discharge	ESD	150	V
Power Dissipation	P <sub>D</sub>	120	mW
Operating temperature range	Top	-30 ~+85	°C
Storage temperature range	Tstg	-40 ~+100	°C

**A-BRIGHT** A-BRIGHT INDUSTRIAL CO., LTD.  
**SURFACE MOUNT CHIP LED LAMPS**

**Part Number: 99-215UWC/TR8**

**Test items and results of reliability**

NO	ITEM	Test Conditions	Test hours/cycle	Sample Q'ty	Ac/Re
1	Solder Heat	Temp : 260°C±5°C	5 sec	30 pcs	0/1
2	Temperature Cycle	-40°C 30min	100 cycles	30 pcs	0/1
		-25°C 5min			
		-105°C 30min			
		-25°C 5min			
3	Thermal Shock	-40°C 5min	20 cycles	30 pcs	0/1
		-105°C 5min			
4	High Temperature Storage	Temp : 85°C	1000 hrs	30 pcs	0/1
5	Low Temperature Storage	Temp : -35°C	1000 hrs	30 pcs	0/1
6	DC Operating Life	I <sub>F</sub> =350mA	1000 hrs	30 pcs	0/1
7	High Temperature / High Humidity	T <sub>a</sub> =60°C R.H 90%	1000 hrs	30 pcs	0/1

\* Refer to reliability test standard specification for in this line.

# **A-BRIGHT** A-BRIGHT INDUSTRIAL CO., LTD. SURFACE MOUNT CHIP LED LAMPS

Part Number: 99-215UWC/TR8

## Color Ranks

### Color Ranks

	Rank A0			
x	0.280	0.264	0.283	0.296
y	0.248	0.267	0.305	0.276

	Rank B1			
x	0.287	0.283	0.330	0.330
y	0.295	0.305	0.360	0.339

	Rank B2			
x	0.296	0.287	0.330	0.330
y	0.276	0.295	0.339	0.318

	Rank C0			
x	0.330	0.330	0.361	0.356
y	0.318	0.360	0.385	0.351

### CIE Chromaticity Diagram

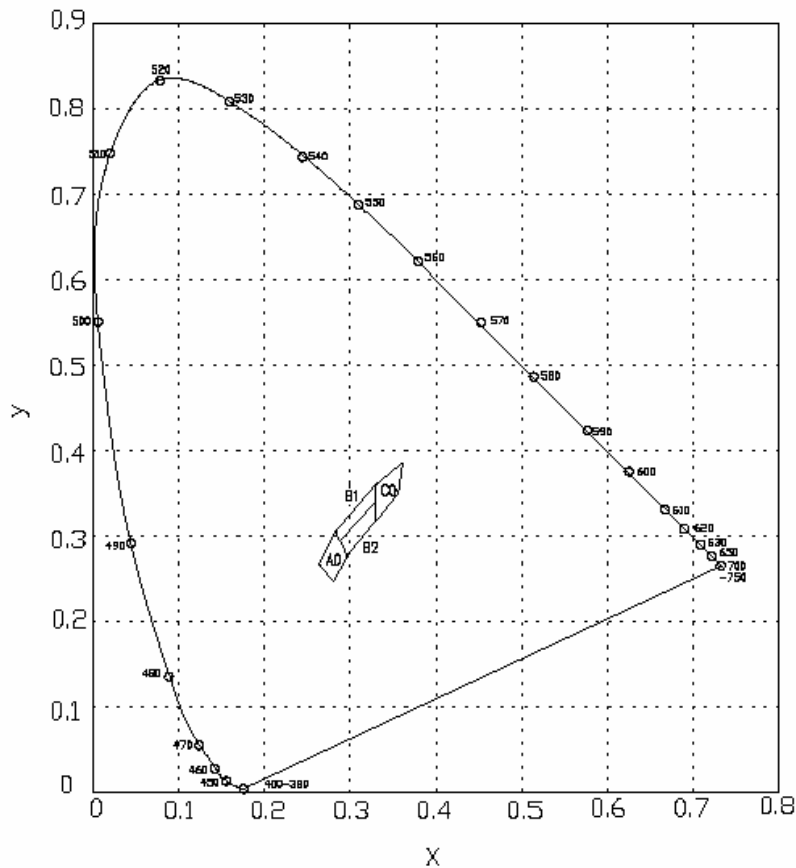

# **A-BRIGHT** A-BRIGHT INDUSTRIAL CO., LTD. SURFACE MOUNT HIP LED LAMPS

Part Number: 99-215UWC/TR8

## Typical Electro-Optical Characteristic Curves

### ◆ TYPICAL ELECTRICAL-OPTICAL CHARACTERISTICS CURVES

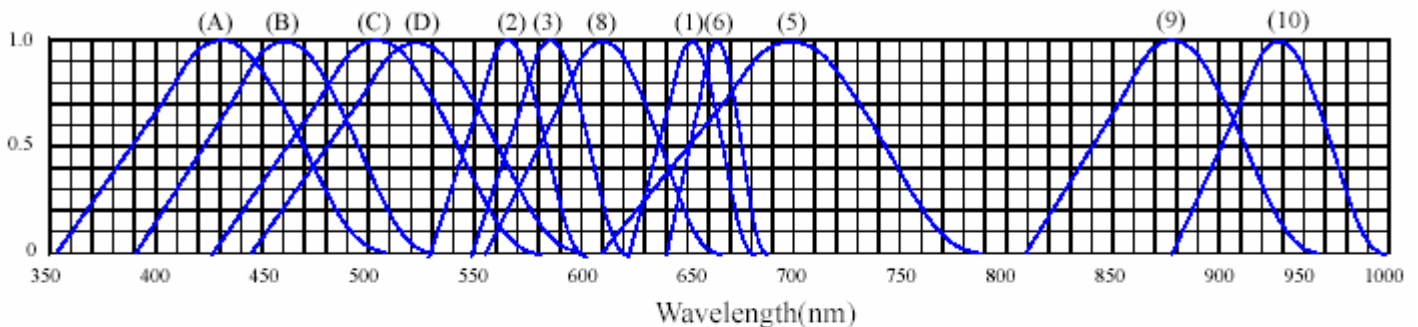
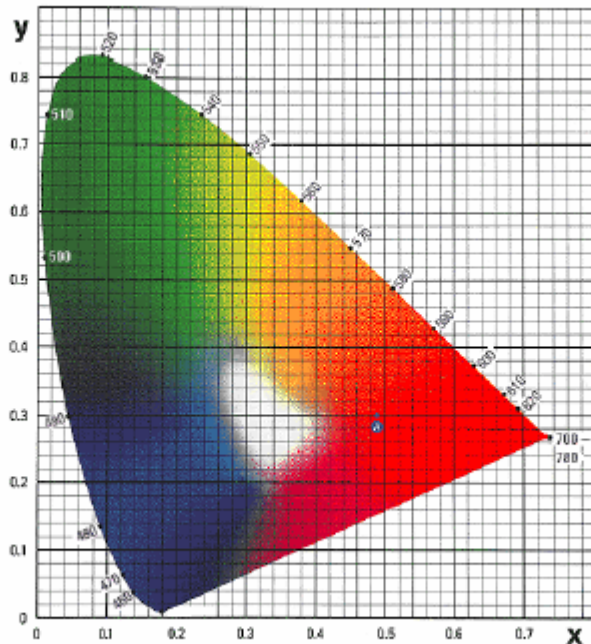

RELATIVE INTENSITY VS. WAVELENGTH( $\lambda_p$ )

- |   |                                  |
|---|----------------------------------|
| (1) GaAsP/GaAs 655nm/Red                | (9)- GaAlAs 880nm                |
| (2) GaP 568nm/ Yellow Green             | (10)-GaAs/GaAs&GaAlAs/GaAs 940nm |
| (3) GaAsP/GaP 585nm/Yellow              | (A)- GaN 430nm/Blue              |
| (4) GaAsP/GaP 635nm/Orange & Hi-Eff Red | (B)- InGaN 470nm/Blue            |
| (5) GaP 700nm/Bright Red                | (C)- InGaN 502nm/Ultra Green     |
| (6) GaAlAs/GaAs 660nm/Super Red         | (D)- InGaN 523nm/Ultra Green     |
| (8) GaAsP/GaP 610nm/Super Red           |                                  |

# **A-BRIGHT** A-BRIGHT INDUSTRIAL CO., LTD. SURFACE MOUNT HIP LED LAMPS

Part Number: 99-215UWC/TR8

## Typical Electro-Optical Characteristic Curves

### ◆ CHARACTERISTICS DIAGRAMS

FORWARD CURRENT VS. FORWARD VOLTAGE

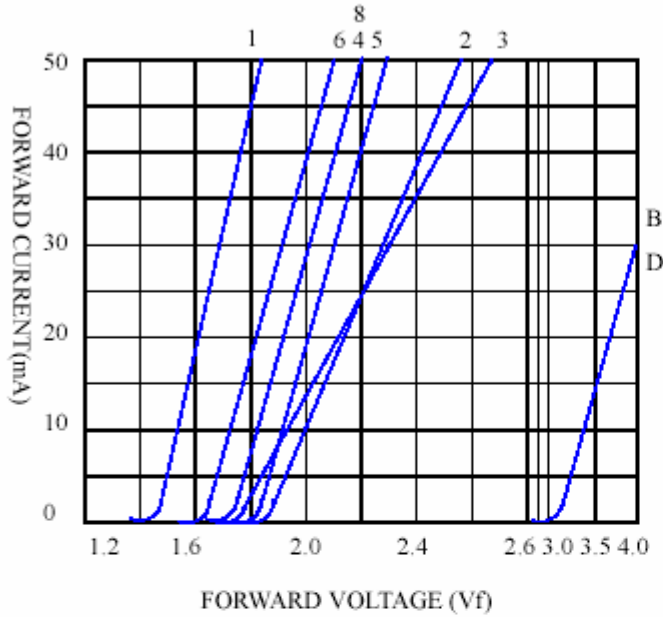

RELATIVE LUMINOUS INTENSITY VS. FORWARD CURRENT

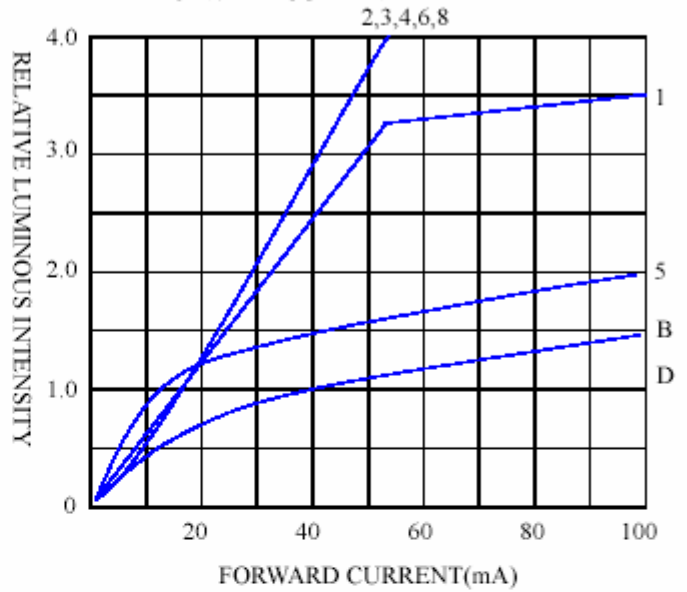

FORWARD CURRENT VS. AMBIENT TEMPERATURE

