

500mA Low Dropout Positive Voltage Regulator

TO-92



SOT-223



Pin Definition:

- 1. Fixed / Adj
- 2. Output
- 3. Input

SOT-89



Pin Definition:

TS1115

- 1. Fixed / Adj
- 2. Output
- 3. Input

TS1115A

- 1. Output
- 2. Fixed / Adj
- 3. Input

General Description

The TS1115 Series are high performance positive voltage regulators are designed for use in applications requiring low dropout performance at full rated current, Additionally, the TS1115 Series provides excellent regulation over variations due to changes in line, load and temperature. Outstanding features include low dropout performance at rated current, fast transient response, internal current limiting and thermal shutdown protection of the output device. The TS1115 Series are three terminal regulators with fixed and adjustable voltage options available in popular packages.

Features

- Low Dropout Performance 1.5V max.
- Full Current Rating Over Line and Temperature
- Fast Transient Response
- ±2% Total Output Regulation Over Line, Load and Temperature
- Adjust Pin Current max 90uA Over Temperature
- Line Regulation Typical 0.015%
- Load Regulation Typical 0.05%
- Fixed / Adjustable Output Voltage
- TO-92, SOT-223 and SOT-89 Package

Ordering Information

Part No.	Package	Packing
TS1115CT \underline{xx} B0	TO-92	1Kpcs / Bulk
TS1115CW \underline{xx} RP	SOT-223	2.5Kpcs / 13" Reel
TS1115CY \underline{xx} RM	SOT-89	1Kpcs / 7" Reel
TS1115ACY \underline{xx} RM	SOT-89	1Kpcs / 7" Reel

Note: Where \underline{xx} denotes voltage option, available are 5.0V, 3.3V, 2.5V, 1.8V and 1.5V. Leave blank for adjustable version. Contact factory for additional voltage options.

Block Diagram

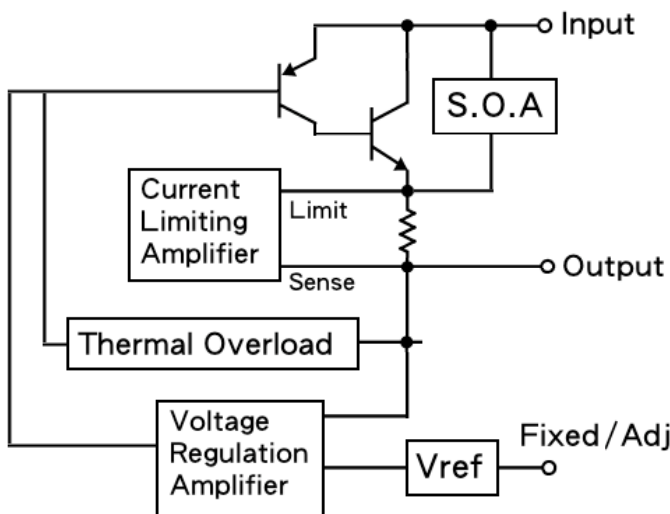

Typical Application Circuit

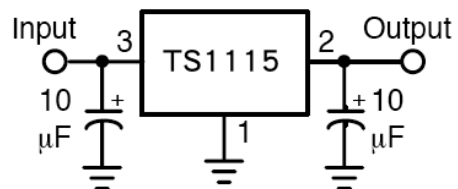

Fixed Output Voltage Version

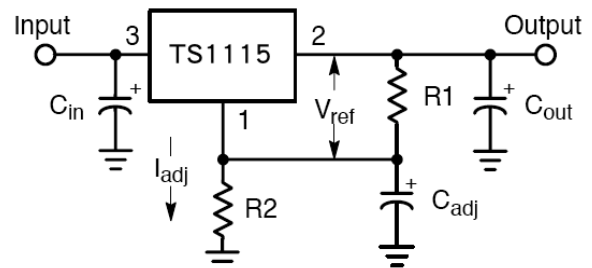

$$V_{out} = V_{ref}(1+R2/R1) + I_{adj} R2$$

Adjustable Output Voltage Version

Absolute Maximum Rating (Note 1)

Parameter	Symbol	Limit	Unit
Input Supply Voltage	V_{IN}	15	V
Operation Input Supply Voltage (Recommend)	V_{IN} (Opr. Typ.)	7	V
Power Dissipation (Note 2)	P_D	Internal limited	
Thermal Resistance Junction to Ambient	TO-92	160	°C/W
	SOT-223	110	
	SOT-89	180	
Operating Junction Temperature Range	T_J	0 ~ +125	°C
Storage Temperature Range	T_{STG}	-65 ~ +150	°C
Lead Soldering Temperature (260°C)		5	S

Electrical Specification (Ta = 25°C, unless otherwise specified.)

Parameter	Conditions	Min	Typ	Max	Unit
Reference Voltage	$V_{IN} = 2.75, I_o = 500mA$	1.225	1.25	1.275	V
Output Voltage	$V_{IN} = 3V \sim 7V, I_o = 500mA$	1.470	1.5	1.530	V
	$V_{IN} = 3.3V \sim 7V, I_o = 500mA$	1.764	1.8	1.836	V
	$V_{IN} = 4V \sim 7V, I_o = 500mA$	2.450	2.5	2.550	V
	$V_{IN} = 4.8V \sim 7V, I_o = 500mA$	3.235	3.3	3.366	V
	$V_{IN} = 6.5V \sim 7V, I_o = 500mA$	4.900	5.0	5.100	V
	Line Regulation	$V_O + 1.5V \leq V_{IN} \leq 7V, I_o = 10mA$	--	0.015	0.2
Load Regulation (Note 1,2)	$V_{IN} = V_{OUT} + 1.5V$ $I_o = 10mA \sim 500mA$	--	0.05	1.0	%
Dropout Voltage	$I_o = 500mA, \Delta V_{OUT} = 1\% V_{OUT}$	--	1.3	1.5	V
Quiescent Current	$V_{IN} = 5V$	--	8	10	mA
Adjustable Pin Current		--	90	--	uA
Output Current Limit	$V_{IN} - V_{OUT} = 3V$	1.1	--	--	A
Temperature Stability	$I_o = 10mA,$	--	0.5	--	%
Ripple Rejection	$F = 120Hz, I_o = 500mA, C_{OUT} = 25uF,$ $V_{IN} = V_{out} + 3V$	--	60	70	dB

Note 1: See thermal regulation specification for changes in output voltage due to heating effects. Line and load regulation are measured at a constant junction temperature by low duty cycle pulse testing. Load regulation is measured at the output lead = 1/18" from the package.

Note 2: Line and load regulation are guaranteed up to the maximum power dissipation of 15W. Power dissipation is determined by the input / output voltage difference and the output current. Guaranteed maximum power dissipation will not be available over the full input / output voltage range.

Note 3: Quiescent current is defined as the minimum output current required to maintain the regulation.

Electrical Characteristics Curve

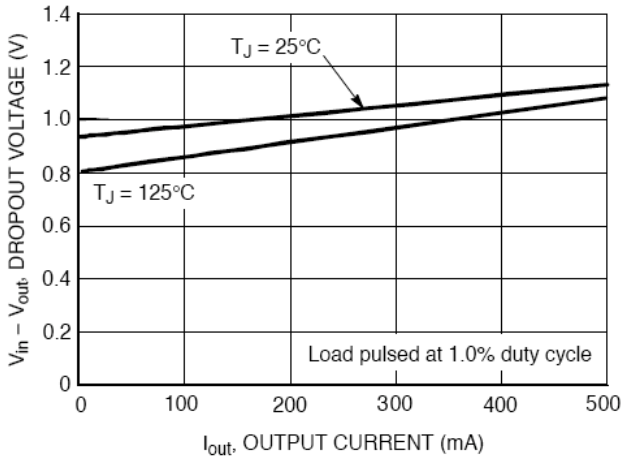

Figure 1. Vdrop vs. Output Current

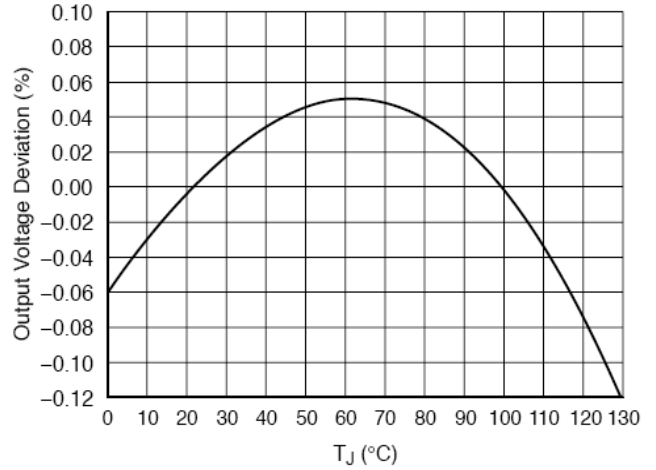

Figure 2. Reference Voltage vs. Temperature

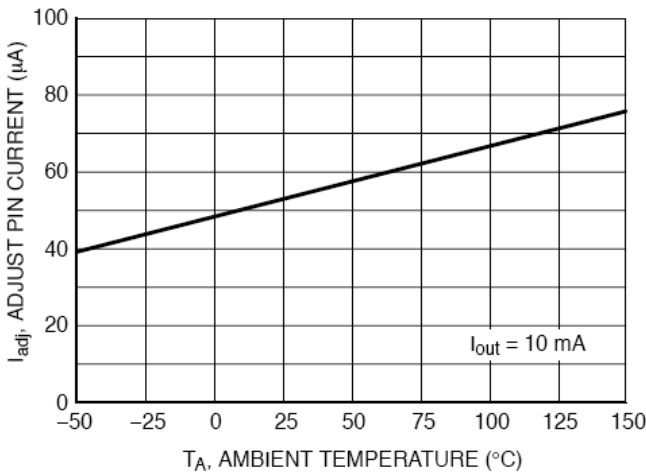

Figure 3. Iadj Pin vs. Temperature

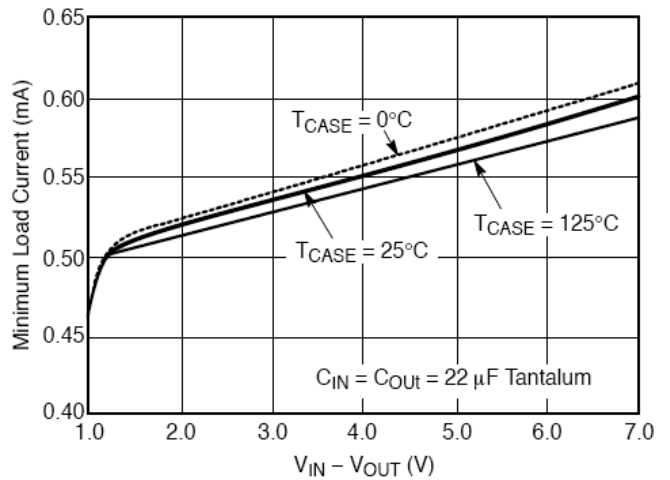

Figure 4. Minimum Load Current

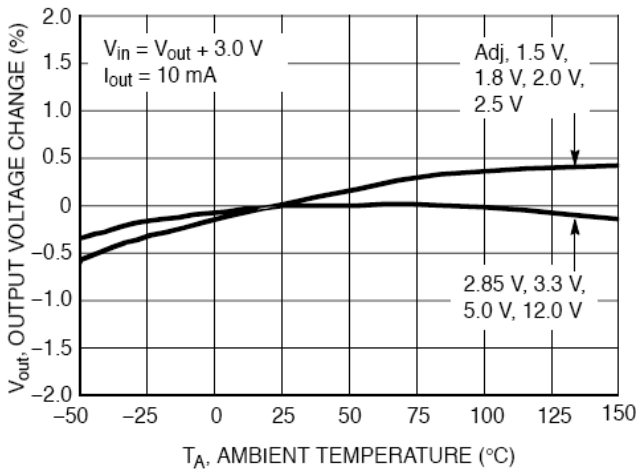

Figure 5. Vout Change vs. Temperature

Application Information

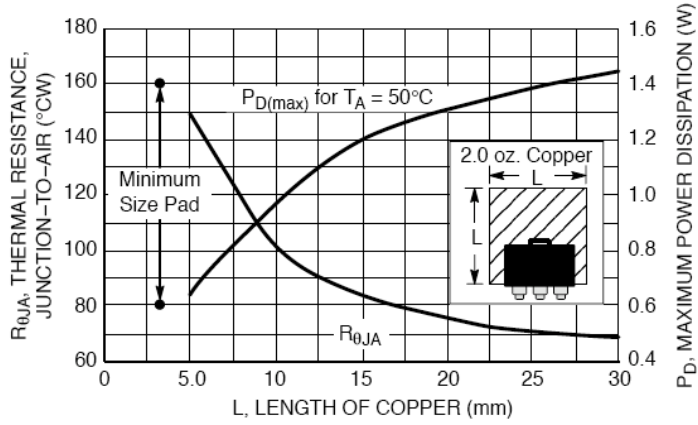
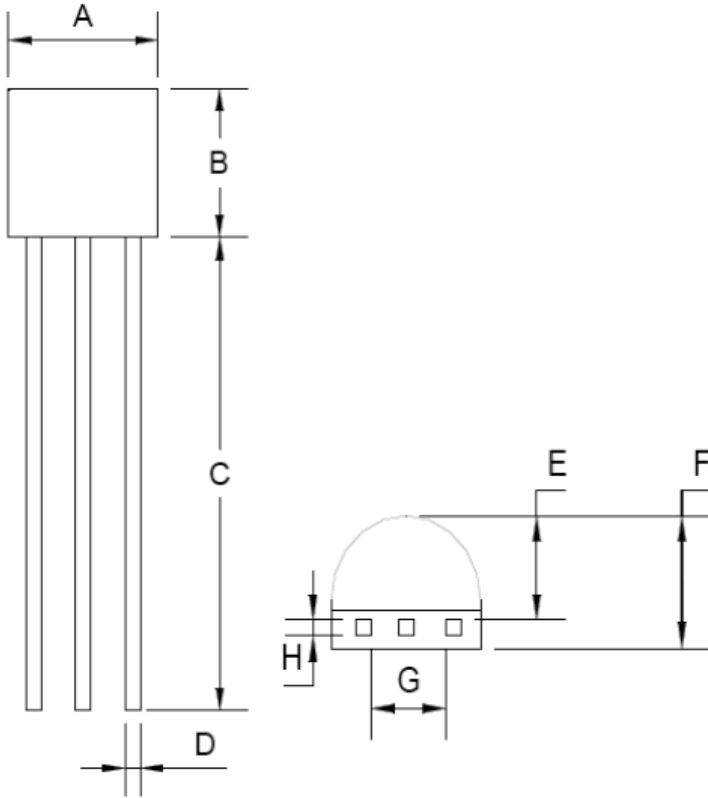

Figure 6 – SOT-223 Thermal Resistance and Maximum Power Dissipation vs. P.C.B Copper Length

TO-92 Mechanical Drawing



TO-92 DIMENSION				
DIM	MILLIMETERS		INCHES	
	MIN	MAX	MIN	MAX
A	4.30	4.70	0.169	0.185
B	4.30	4.70	0.169	0.185
C	14.30(typ)		0.563(typ)	
D	0.43	0.49	0.017	0.019
E	2.19	2.81	0.086	0.111
F	3.30	3.70	0.130	0.146
G	2.42	2.66	0.095	0.105
H	0.37	0.43	0.015	0.017

Marking Diagram

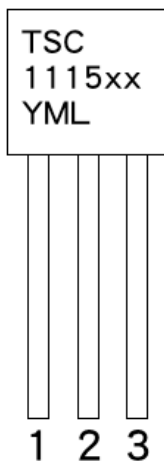

- XX** = Voltage Code
(15=1.5V, 18=1.8V, 25=2.5V, 33=3.3V, 50=5V)
= Leave Blank for Adjustable type
- Y** = Year Code
- M** = Month Code
(A=Jan, B=Feb, C=Mar, D=Apr, E=May, F=Jun, G=Jul, H=Aug, I=Sep, J=Oct, K=Nov, L=Dec)
- L** = Lot Code

SOT-89 Mechanical Drawing

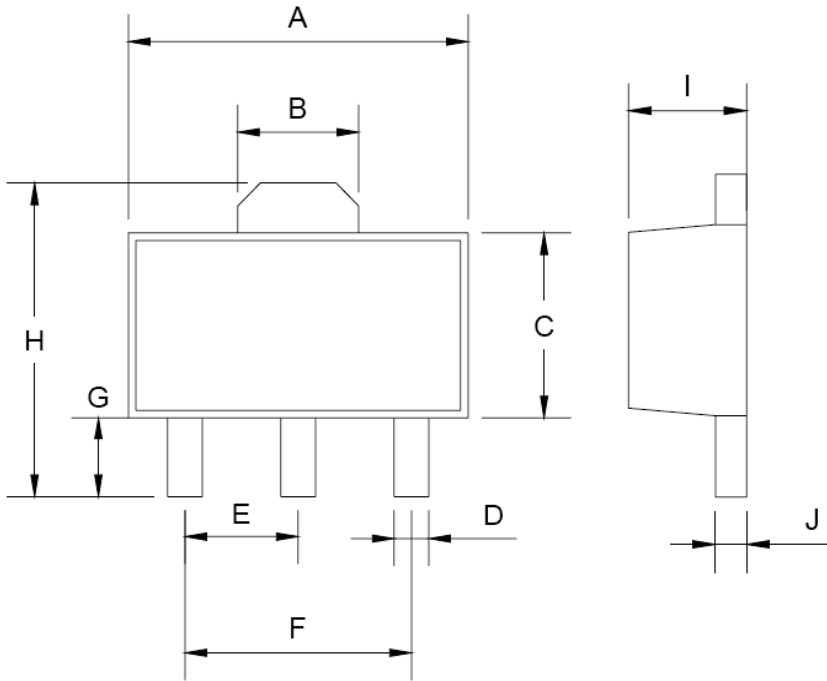

SOT-89 DIMENSION				
DIM	MILLIMETERS		INCHES	
	MIN	MAX	MIN	MAX
A	4.40	4.60	0.173	0.181
B	1.50	1.7	0.059	0.070
C	2.30	2.60	0.090	0.102
D	0.40	0.52	0.016	0.020
E	1.50	1.50	0.059	0.059
F	3.00	3.00	0.118	0.118
G	0.89	1.20	0.035	0.047
H	4.05	4.25	0.159	0.167
I	1.4	1.6	0.055	0.068
J	0.35	0.44	0.014	0.017

Marking Diagram

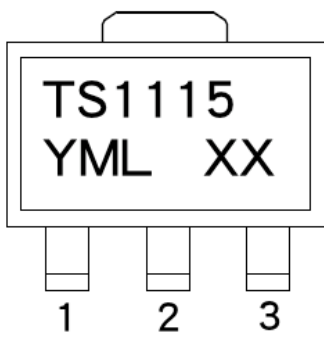

- Y** = Year Code
- M** = Month Code
(A=Jan, B=Feb, C=Mar, D=Apr, E=May, F=Jun, G=Jul, H=Aug, I=Sep, J=Oct, K=Nov, L=Dec)
- L** = Lot Code
- XX** = Voltage Code
(15=1.5V, 18=1.8V, 25=2.5V, 33=3.3V, 50=5V)
= Package Code for Adjustable type
(CY = SOT-89)

SOT-223 Mechanical Drawing

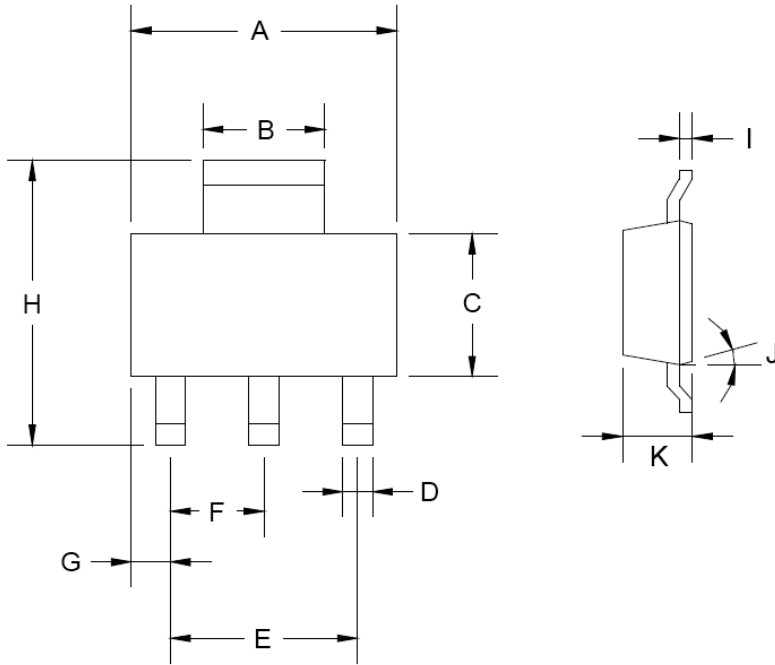

SOT-223 DIMENSION				
DIM	MILLIMETERS		INCHES	
	MIN	MAX	MIN	MAX
A	6.350	6.850	0.250	0.270
B	2.900	3.100	0.114	0.122
C	3.450	3.750	0.136	0.148
D	0.595	0.635	0.023	0.025
E	4.550	4.650	0.179	0.183
F	2.250	2.350	0.088	0.093
G	0.835	1.035	0.032	0.041
H	6.700	7.300	0.263	0.287
I	0.250	0.355	0.010	0.014
J	10°	16°	10°	16°
K	1.550	1.800	0.061	0.071

Marking Diagram

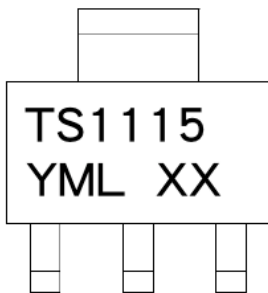

- Y** = Year Code
- M** = Month Code
(**A**=Jan, **B**=Feb, **C**=Mar, **D**=Apr, **E**=May, **F**=Jun, **G**=Jul, **H**=Aug, **I**=Sep, **J**=Oct, **K**=Nov, **L**=Dec)
- L** = Lot Code
- XX** = Voltage Code
(**15**=1.5V, **18**=1.8V, **25**=2.5V, **33**=3.3V, **50**=5V)
= Package Code for Adjustable type
(CW = SOT-223)

Notice

Specifications of the products displayed herein are subject to change without notice. TSC or anyone on its behalf, assumes no responsibility or liability for any errors or inaccuracies.

Information contained herein is intended to provide a product description only. No license, express or implied, to any intellectual property rights is granted by this document. Except as provided in TSC's terms and conditions of sale for such products, TSC assumes no liability whatsoever, and disclaims any express or implied warranty, relating to sale and/or use of TSC products including liability or warranties relating to fitness for a particular purpose, merchantability, or infringement of any patent, copyright, or other intellectual property right.

The products shown herein are not designed for use in medical, life-saving, or life-sustaining applications. Customers using or selling these products for use in such applications do so at their own risk and agree to fully indemnify TSC for any damages resulting from such improper use or sale.