

TOSHIBA Bipolar Linear Integrated Circuit SiGe Monolithic

# TA4500F

1.9 GHz Band RX Front-End IC

PHS, Digital Cordless Telecommunication Applications

## Features

- Low-noise amplifier / down-conversion mixer
- Integrated local buffer amplifier
- Single positive power supply:  $V_{CC} = 3.0\text{ V}$
- Large conversion gain:  $G_{LNA} = 17.5\text{ dB (typ.)}$   
 $G_{MIX} = 5.0\text{ dB (typ.)}$
- High input IP3:  $IIP3_{LNA} = -7.5\text{ dBmW (typ.)}$   
 $IIP3_{MIX} = 7.0\text{ dBmW (typ.)}$
- High 1/2 IF reduction ratio:  $1/2IFR_{MIX} = 45\text{ dB (typ.)}$
- Small package: QS16 (2.5 mm × 2.5 mm × 0.55 mm)

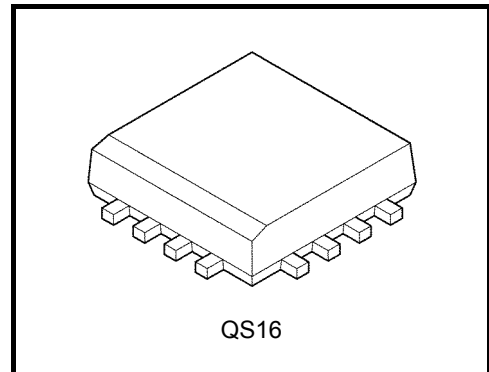

Weight: 0.0065 g (typ.)

## Absolute Maximum Ratings (Ta = 25°C)

Characteristic	Symbol	Rating	Unit
Supply voltage	$V_{CC}$ (Note 1)	4.5	V
Input power	$P_{IN}$ (RF_IN)	10	dBmW
	$P_{IN}$ (LO_IN)	0	dBmW
	$P_{IN}$ (MIX_IN)	0	dBmW
Power dissipation	$P_d$ (Note 2)	500	mW
Operating temperature range	$T_{opr}$	-40 to +85	°C
Storage temperature range	$T_{stg}$	-55 to +150	°C

Note: Using continuously under heavy loads (e.g. the application of high temperature/current/voltage and the significant change in temperature, etc.) may cause this product to decrease in the reliability significantly even if the operating conditions (i.e. operating temperature/current/voltage, etc.) are within the absolute maximum ratings and the operating ranges.

Please design the appropriate reliability upon reviewing the Toshiba Semiconductor Reliability Handbook (“Handling Precautions”/“Derating Concept and Methods”) and individual reliability data (i.e. reliability test report and estimated failure rate, etc).

Note 1:  $V_{CC} = V_{CC1} = V_{CC2} = V_{CC3}$

Note 2: When mounted on a 30 mm × 35 mm × 0.6 mm FR4 substrate at Ta = 25°C (double-sided substrate: the reverse side is ground connection)

## Caution

This device is sensitive to electrostatic discharge. When handling this product, ensure that the environment is protected against electrostatic discharge by using an earth strap, a conductive mat and an ionizer.

## Electrical Characteristics

$V_{CC} = 3.0\text{ V}$ ,  $T_a = 25^\circ\text{C}$ ,  $Z_g = Z_l = 50\ \Omega$

Characteristic	Symbol	Test Condition	Min	Typ	Max	Unit
<b>Total</b>						
Operating frequency	f	—	1.884	—	1.920	GHz
Operating supply voltage	$V_{CC}$	—	2.7	3.0	3.3	V
Supply current	$I_{CC}$	$pRF\_IN = pLO\_IN = pMIX\_IN = 0\text{ mW}$ (no signal)	—	15.0	22.0	mA
<b>Low Noise Amplifier (LNA) Block</b>						
Power gain	$G_{LNA}$	$f_{RF\_IN} = 1.9\text{ GHz}$ , $p_{RF\_IN} = -35\text{ dBmW}$	15.0	17.5	22.0	dB
Noise figure	$NF_{LNA}$	Measured at 1.9 GHz	—	2.2	3.0	dB
Input IP3	$IIP3_{LNA}$	(Note 3)	-13.5	-7.5	—	dBmW
<b>Down Conversion Mixer (MIX) Block</b>						
Conversion gain	$G_{MIX}$	$f_{MIX\_IN} = 1.9\text{ GHz}$ , $p_{MIX\_IN} = -25\text{ dBmW}$ , $f_{LO\_IN} = 1.66\text{ GHz}$ , $p_{LO\_IN} = -15\text{ dBmW}$ , measured at $IF\_OUT1$ , $IF\_OUT2$ terminated via $50\ \Omega$ and vice versa	2.8	5.0	7.0	dB
Noise figure	$NF_{MIX}$	$f_{LO\_IN} = 1.66\text{ GHz}$ , $p_{LO\_IN} = -15\text{ dBmW}$ , measured at $IF\_OUT1$ , $IF\_OUT2$ terminated via $50\ \Omega$ and vice versa, $f_{IF\_OUT} = 240\text{ MHz}$ , DSB (Note 4)	—	13.0	17.5	dB
Input IP3	$IIP3_{MIX}$	$f_{LO\_IN} = 1.66\text{ GHz}$ , $p_{LO\_IN} = -15\text{ dBmW}$ , measured at $IF\_OUT1$ , $IF\_OUT2$ terminated via $50\ \Omega$ and vice versa (Note 5)	-1.0	7.0	—	dBmW
1/2 IF reduction ratio	$1/2IFR_{MIX}$	$f_{MIX\_IN} = 1.9\text{ GHz}$ , $1.78\text{ GHz}$ , $p_{MIX\_IN} = -25\text{ dBmW}$ , $f_{LO\_IN} = 1.66\text{ GHz}$ , $p_{LO\_IN} = -15\text{ dBmW}$ , measured at $IF\_OUT1$ , $IF\_OUT2$ terminated via $50\ \Omega$ and vice versa, $f_{IF\_OUT} = 240\text{ MHz}$	—	45.0	—	dB
Local leak power	$P_{LK}$	$f_{LO\_IN} = 1.66\text{ GHz}$ , $p_{LO\_IN} = -15\text{ dBmW}$ , measured at $MIX\_IN$ , $IF\_OUT1$ , 2 terminated via $50\ \Omega$	—	-40.0	—	dBmW

Note 3:  $IIP3$  of the LNA block is converted from  $IM3$  when  $RF1 = 1.900\text{ GHz} / -35\text{ dBmW}$ ,  $RF2 = 1.9006\text{ GHz} / -35\text{ dBmW}$  are input to  $RF\_IN$ .

Note 4: Measured with the high pass filter shown below connected to  $MIX\_IN$ .

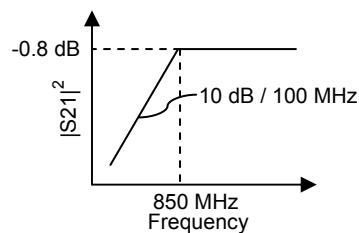
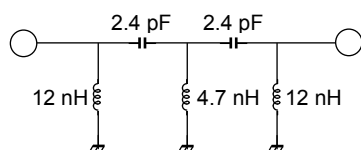

Note 5:  $IIP3$  of the MIX block is converted from  $IM3$  when  $RF1 = 1.900\text{ GHz} / -25\text{ dBmW}$ ,  $RF2 = 1.9006\text{ GHz} / -25\text{ dBmW}$  are input to  $MIX\_IN$ .

Note 6: All tests for electrical characteristics are performed using the test board shown on page 4.

**Block Diagram and Marking (Top View)**

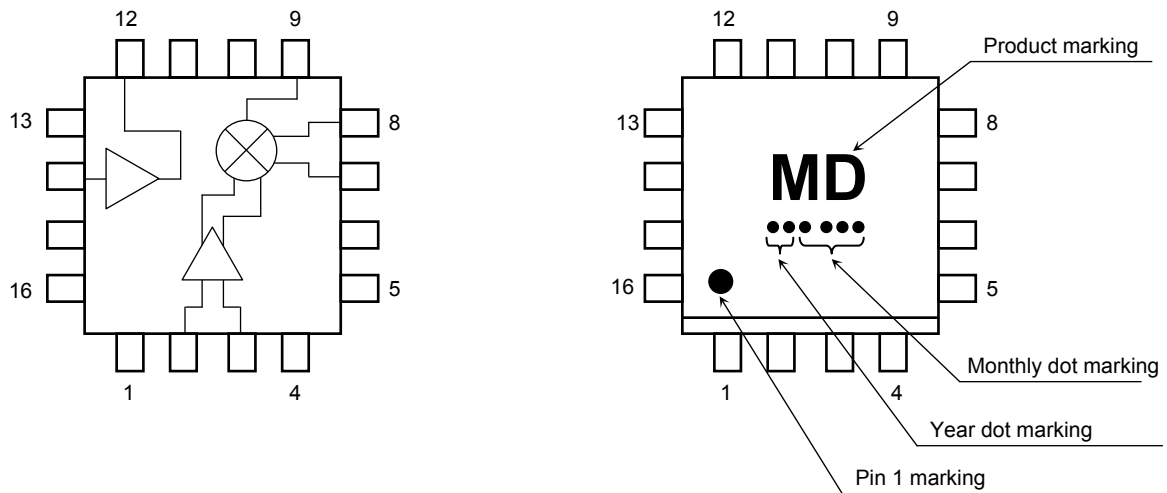

**Pin Configuration**

Pin number	Pin name	Description
1	N.C.	Not connected to the pellet. Connect to ground.
2	LO_term	MIX local input termination pin. To be terminated.
3	LO_IN	MIX local input
4	GND1	Ground.
5	GND2	Ground.
6	V <sub>CC2</sub>	Supply pin for MIX.
7	IF_OUT2	MIX IF output. Biasing circuit is necessary.
8	IF_OUT1	MIX IF output. Biasing circuit is necessary.
9	MIX_IN	MIX RF input.
10	V <sub>CC1</sub>	Supply pin for LNA and biasing circuits.
11	LNA_ind	LNA emitter. Connect to ground via 1 nH inductance // 1 pF capacitance.
12	LNA_OUT	LNA output. Biasing circuit is necessary.
13	GND3	Ground.
14	RF_IN	LNA input.
15	GND4	Ground.
16	V <sub>CC3</sub>	Supply pin for MIX.

**Circuit Diagram of Test Board**

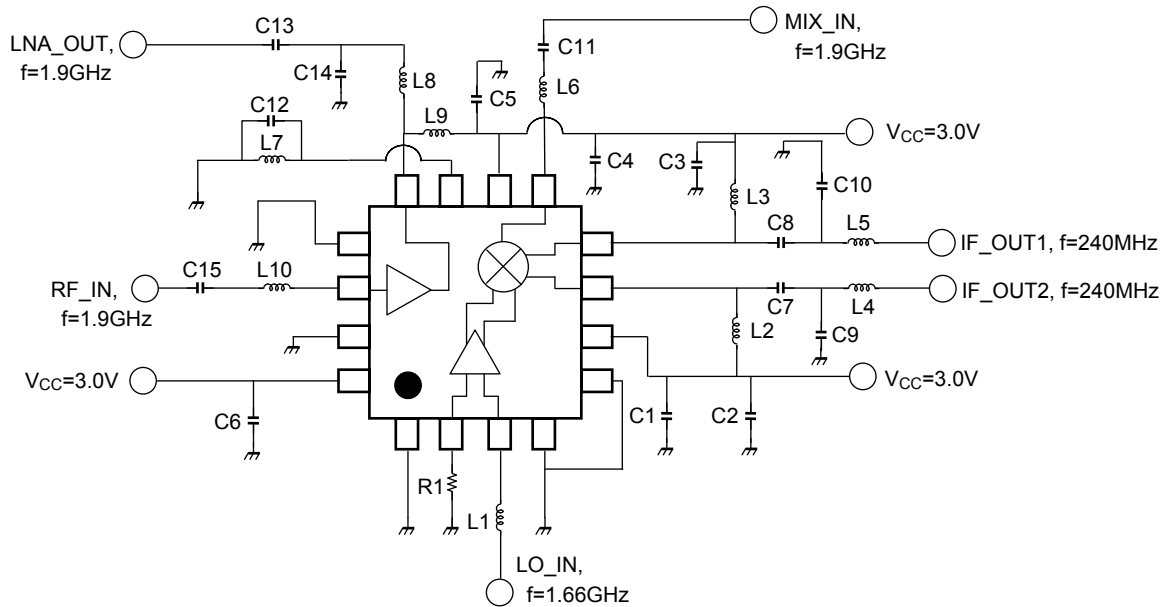

**List of External Chip Components**

Part	Value	Chip Series	Description
C1	1000 pF	GRM15 series MURATA	Decoupling capacitor
C2	1000 pF	GRM15 series MURATA	Decoupling capacitor
C3	1000 pF	GRM15 series MURATA	Decoupling capacitor
C4	1000 pF	GRM15 series MURATA	Decoupling capacitor
C5	1000 pF	GRM15 series MURATA	Decoupling capacitor
C6	1000 pF	GRM15 series MURATA	Decoupling capacitor
C7	1000 pF	GRM15 series MURATA	DC blocking capacitor
C8	1000 pF	GRM15 series MURATA	DC blocking capacitor
C9	5 pF	GRM15 series MURATA	IF_OUT matching
C10	5 pF	GRM15 series MURATA	IF_OUT matching
C11	39 pF	GRM15 series MURATA	MIX_IN matching
C12	1 pF	GRM15 series MURATA	Determining LNA gain
C13	82 pF	GRM15 series MURATA	LNA_OUT matching
C14	1.2 pF	GRM15 series MURATA	LNA_OUT matching
C15	3 pF	GRM15 series MURATA	RF_IN matching
L1	8.2 nH	LQG15HN series MURATA	LO_IN matching
L2	120 nH	LQG15HN series MURATA	MIX output load
L3	120 nH	LQG15HN series MURATA	MIX output load
L4	120 nH	LQG15HN series MURATA	IF_OUT matching
L5	120 nH	LQG15HN series MURATA	IF_OUT matching
L6	8.2 nH	LQG15HN series MURATA	MIX_IN matching
L7	1 nH	LQG15HN series MURATA	Determining LNA gain
L8	10 nH	LQG15HN series MURATA	LNA_OUT matching
L9	15 nH	LQG15HN series MURATA	LNA output load
L10	6.8 nH	LQG15HN series MURATA	LNA_IN matching
R1	51 Ω	MCR01 series ROHM	LO termination load

## Typical Operating Characteristics of Low-Noise Amplifier Block

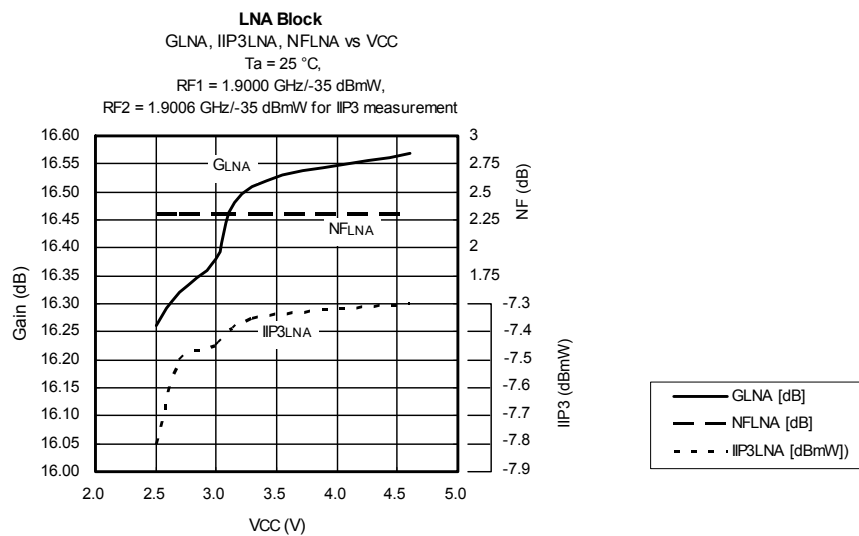
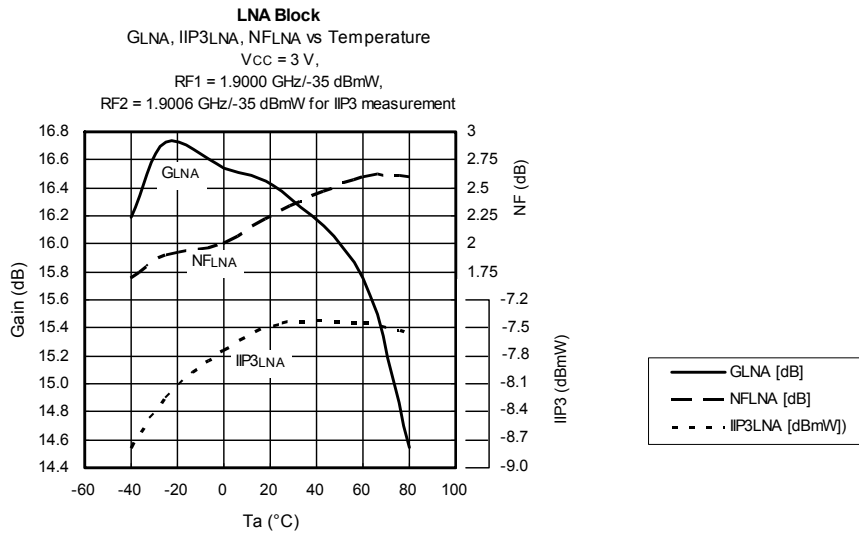
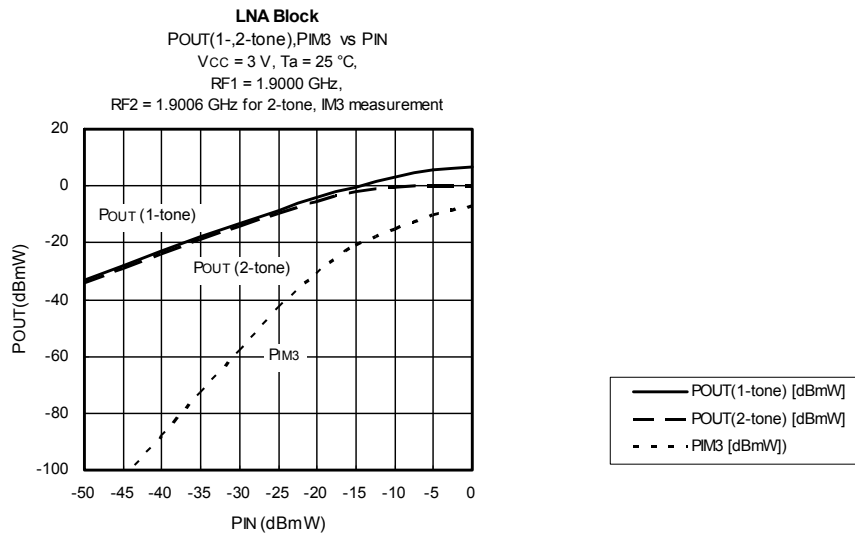

## Typical Operating Characteristics of Down Conversion Mixer Block

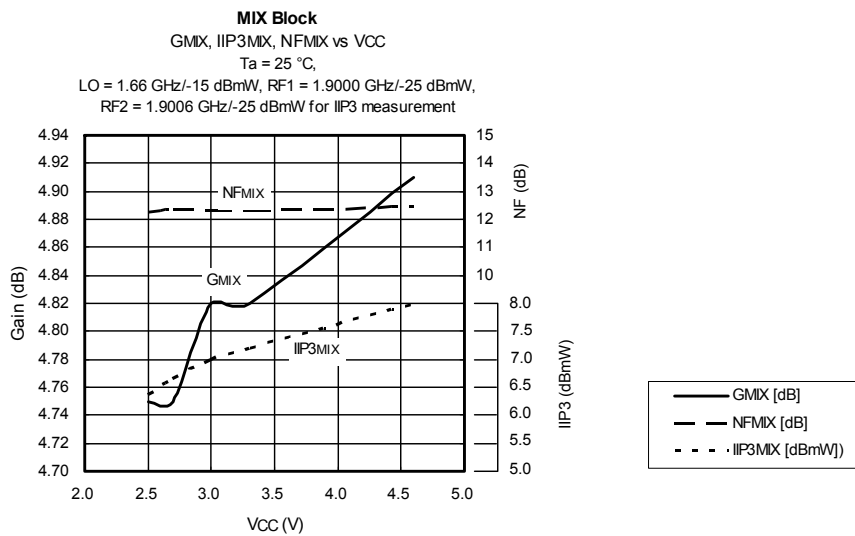
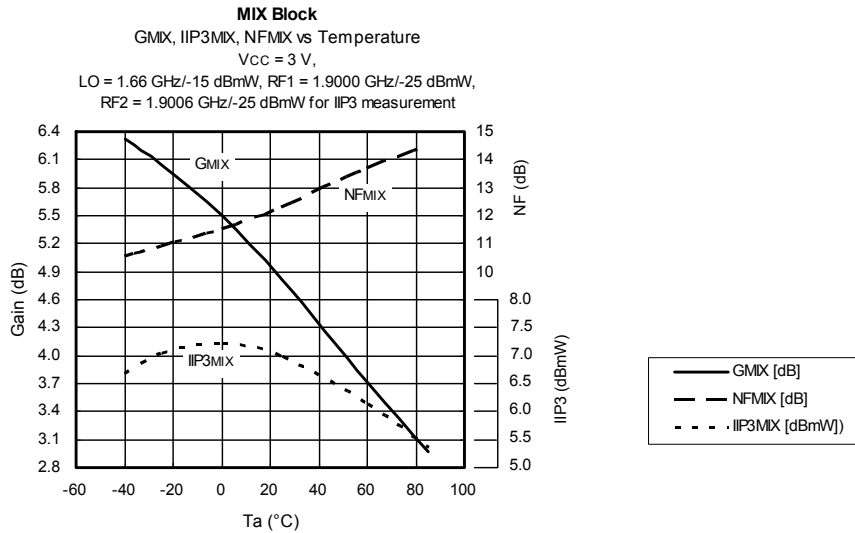
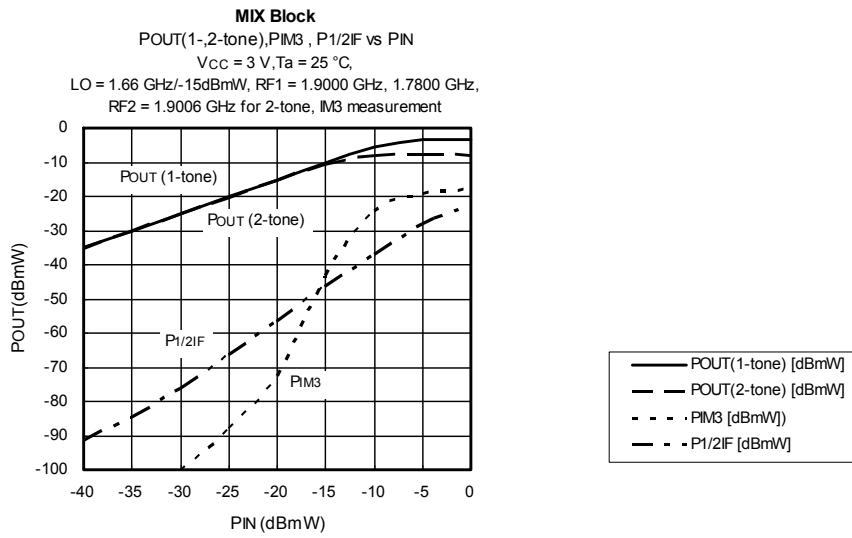

**Typical Operating Characteristics of Down Conversion Mixer Block (continued)**

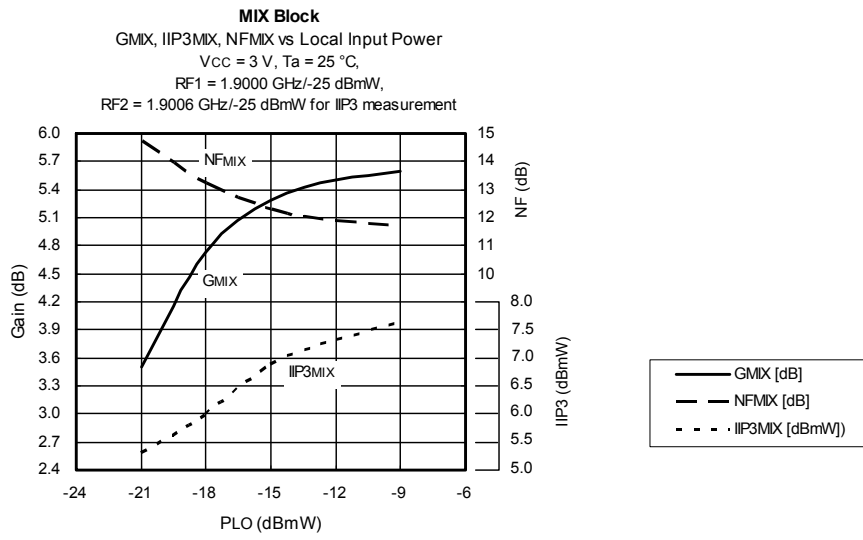

## Circuit Diagram of Evaluation Board

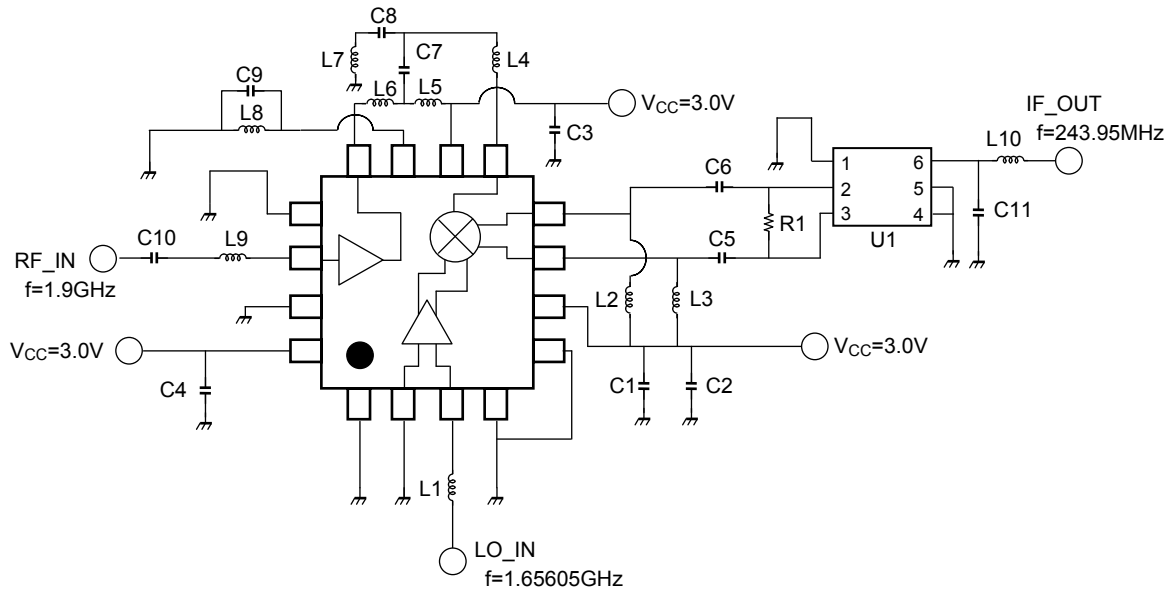

## List of External Chip Components on Evaluation Board

Part	Value	Chip Series	Part	Value	Chip Series
C1	1000 pF	GRM15 series MURATA	L2	120 nH	LQG15HN series MURATA
C2	1000 pF	GRM15 series MURATA	L3	120 nH	LQG15HN series MURATA
C3	1000 pF	GRM15 series MURATA	L4	5.6 nH	LQG15HN series MURATA
C4	1000 pF	GRM15 series MURATA	L5	2.2 nH	LQG15HN series MURATA
C5	1000 pF	GRM15 series MURATA	L6	3.3 nH	LQG15HN series MURATA
C6	1000 pF	GRM15 series MURATA	L7	5.6 nH	LQG15HN series MURATA
C7	1 pF	GRM15 series MURATA	L8	1 nH	LQG15HN series MURATA
C8	2 pF	GRM15 series MURATA	L9	6.8 nH	LQG15HN series MURATA
C9	1 pF	GRM15 series MURATA	L10	100 nH	LQG15HN series MURATA
C10	3 pF	GRM15 series MURATA	R1	1.2 kΩ	MCR01 series ROHM
C11	2.7 pF	GRM15 series MURATA	U1	243.95 MHz	SAFDA243MRD9X00R00 MURATA
L1	8.2 nH	LQG15HN series MURATA			

## Typical Electrical Characteristics of Evaluation Board (for Reference Only)

$V_{CC} = 3.0 \text{ V}$ ,  $T_a = 25^\circ\text{C}$ ,  $Z_g = Z_l = 50 \Omega$ ,  $f_{LO\_IN} = 1.65605 \text{ GHz}$ ,  $p_{LO\_IN} = -15 \text{ dBmW}$ ,  $f_{IF\_OUT} = 243.95 \text{ MHz}$

Characteristic	Symbol	Test Condition	Typ	Unit
Conversion gain	$G_c$	$f_{RF\_IN} = 1.9 \text{ GHz}$ , $p_{RF\_IN} = -30 \text{ dBmW}$ (Note 7)	17.5	dB
Noise figure	NF	DSB	3.8	dB
3 <sup>rd</sup> order intermodulation distortion	IM3	IF output: $f_{RF\_IN} = 1.9 \text{ GHz}$ , $p_{RF\_IN} = -46 \text{ dBmW}$ , 3 <sup>rd</sup> order: $f_{RF\_IN1} = 1.8994 \text{ GHz}$ , $f_{RF\_IN2} = 1.8988 \text{ GHz}$ , $p_{RF\_IN1} = p_{RF\_IN2} = -46 \text{ dBmW}$	64.0	dB
Image reduction ratio	IMR	$f_{RF\_IN} = 1.9 \text{ GHz}$ , $1.4121 \text{ GHz}$ , $p_{RF\_IN} = -46 \text{ dBmW}$	27.0	dB
1/2 IF reduction ratio	1/2IFR	$f_{RF\_IN} = 1.9 \text{ GHz}$ , $1.778025 \text{ GHz}$ , $p_{RF\_IN} = -46 \text{ dBmW}$	48.0	dB

Note 7: Conversion gain in the above table includes the insertion loss (3.5 dB typical) of SAW filter, SAFDA243MRD9X00R00.





**Notice**

The circuits and measurements contained in this document are given in the context of example applications of the product only.

Moreover, these example application circuits are not intended for mass production since the high-frequency characteristics (i.e., the AC characteristics) of the device will be affected by the external components that the customer uses, by the design of the circuit and by various other conditions.

It is the responsibility of the customer to design external circuits that correctly implement the intended application and to check the characteristics of the design.

TOSHIBA assumes no responsibility for the integrity of customer circuit designs or applications.

**Package Physical Dimensions**

QS16

Unit: mm

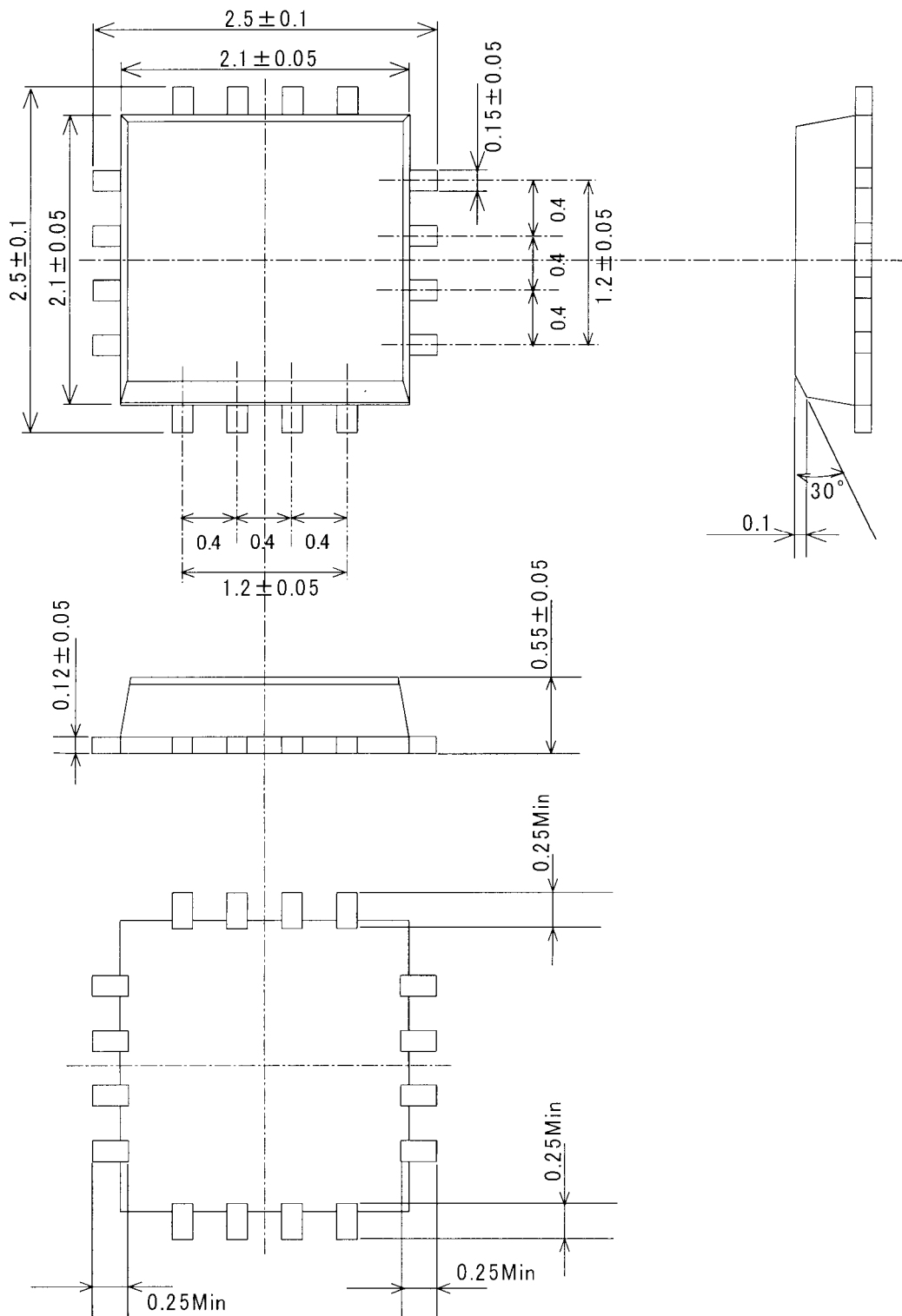

Weight: 0.0065 g (typ.)

**RESTRICTIONS ON PRODUCT USE**

20070701-EN GENERAL

- The information contained herein is subject to change without notice.
- TOSHIBA is continually working to improve the quality and reliability of its products. Nevertheless, semiconductor devices in general can malfunction or fail due to their inherent electrical sensitivity and vulnerability to physical stress. It is the responsibility of the buyer, when utilizing TOSHIBA products, to comply with the standards of safety in making a safe design for the entire system, and to avoid situations in which a malfunction or failure of such TOSHIBA products could cause loss of human life, bodily injury or damage to property.  
In developing your designs, please ensure that TOSHIBA products are used within specified operating ranges as set forth in the most recent TOSHIBA products specifications. Also, please keep in mind the precautions and conditions set forth in the "Handling Guide for Semiconductor Devices," or "TOSHIBA Semiconductor Reliability Handbook" etc.
- The TOSHIBA products listed in this document are intended for usage in general electronics applications (computer, personal equipment, office equipment, measuring equipment, industrial robotics, domestic appliances, etc.). These TOSHIBA products are neither intended nor warranted for usage in equipment that requires extraordinarily high quality and/or reliability or a malfunction or failure of which may cause loss of human life or bodily injury ("Unintended Usage"). Unintended Usage include atomic energy control instruments, airplane or spaceship instruments, transportation instruments, traffic signal instruments, combustion control instruments, medical instruments, all types of safety devices, etc.. Unintended Usage of TOSHIBA products listed in this document shall be made at the customer's own risk.
- The products described in this document shall not be used or embedded to any downstream products of which manufacture, use and/or sale are prohibited under any applicable laws and regulations.
- The information contained herein is presented only as a guide for the applications of our products. No responsibility is assumed by TOSHIBA for any infringements of patents or other rights of the third parties which may result from its use. No license is granted by implication or otherwise under any patents or other rights of TOSHIBA or the third parties.
- Please contact your sales representative for product-by-product details in this document regarding RoHS compatibility. Please use these products in this document in compliance with all applicable laws and regulations that regulate the inclusion or use of controlled substances. Toshiba assumes no liability for damage or losses occurring as a result of noncompliance with applicable laws and regulations.