

TOSHIBA Linear Integrated Circuit Silicon-Germanium Monolithic

TA4020FT

○ UHF LOW NOISE AMPLIFIER APPLICATION

- Thin Extreme Super mini Quad Package (4pin) :TESQ

FEATURES

- Low Noise Figure: NF=0.95dB (@ f=1.5GHz)
- High Gain: $|S_{21e}|^2=15.0\text{dB}$ (@ f=1.5GHz)
- Lead free article

Marking(Tentative)

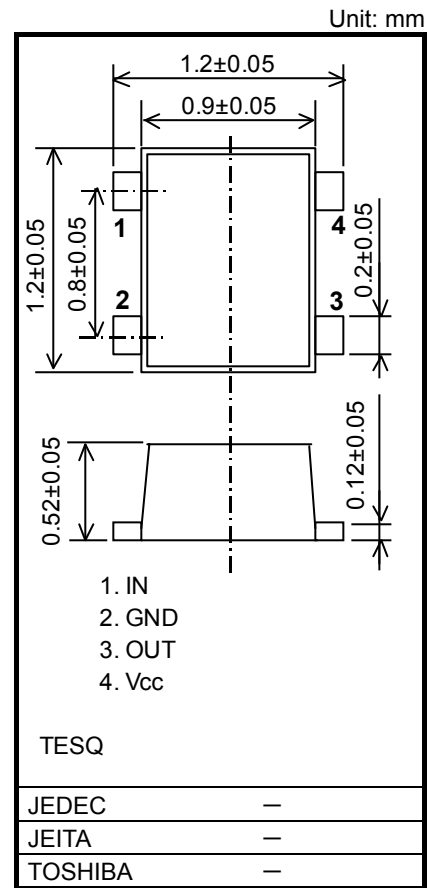
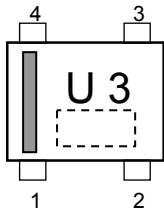

Weight: 0.0015 g

Absolute Maximum Ratings (Ta = 25°C)

Characteristics	Symbol	Rating	Unit
Voltage at pin Vcc	V _{CC}	3.7	V
Current into pin Vcc	I _{CC}	10	mA
RF input power	P _{in}	10	dBmW
Total Power dissipation	P _D	37	mW
Junction temperature	T _j	150	°C
Operate temperature Range	T _{opr}	-40~85	°C
Storage temperature Range	T _{stg}	-55~150	°C

Note: Using continuously under heavy loads (e.g. the application of high temperature/current/voltage and the significant change in temperature, etc.) may cause this product to decrease in the reliability significantly even if the operating conditions (i.e. operating temperature/current/voltage, etc.) are within the absolute maximum ratings and the operating ranges.

Please design the appropriate reliability upon reviewing the Toshiba Semiconductor Reliability Handbook (“Handling Precautions”/“Derating Concept and Methods”) and individual reliability data (i.e. reliability test report and estimated failure rate, etc).

Recommend Operation range

Characteristics	Symbol	Test Condition	Min	Typ.	Max	Unit
Voltage supply	V _{CC}	—	2.3	3.0	3.3	V

Electrical Characteristics (Vcc = 3V, Ta = 25°C)

Characteristics	Symbol	Test Condition	Min	Typ.	Max	Unit
Circuit Current	I _{CC}	V _{CC} = 3V	3.5	5	7	mA
Insertion Gain	S _{21e} ² (1)	V _{CC} = 3V, f = 1.5GHz	13	15	—	dB
	S _{21e} ² (2)	V _{CC} = 3V, f = 2.6GHz	8.5	10.5	—	dB
Noise Figure	NF(1)	V _{CC} = 3V, f = 1.5GHz, Z _s = Z _{sopt}	—	0.95	1.25	dB
	NF(2)	V _{CC} = 3V, f = 2.6GHz, Z _s = Z _{sopt}	—	1.25	—	dB
Input Third order Intercept Point	IIP3(1)	V _{CC} = 3V, f = 1.5GHz	—	-9.5	—	dBmW
	IIP3(2)	V _{CC} = 3V, f = 2.6GHz	—	-4	—	dBmW

Caution:

This device is sensitive to electrostatic discharge due to applied the high frequency transistor process of f_T=60GHz class is used for this product.

Please make enough tool and equipment earthed when you handle.

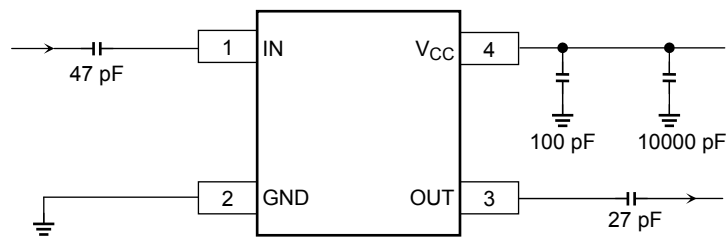

RF Test Circuit (Top View)

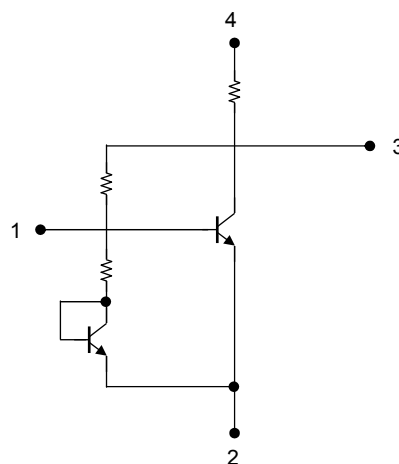

Equivalent Circuit

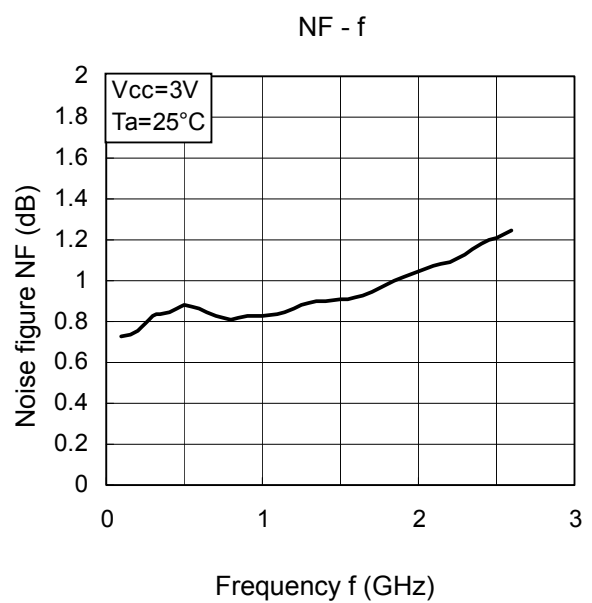
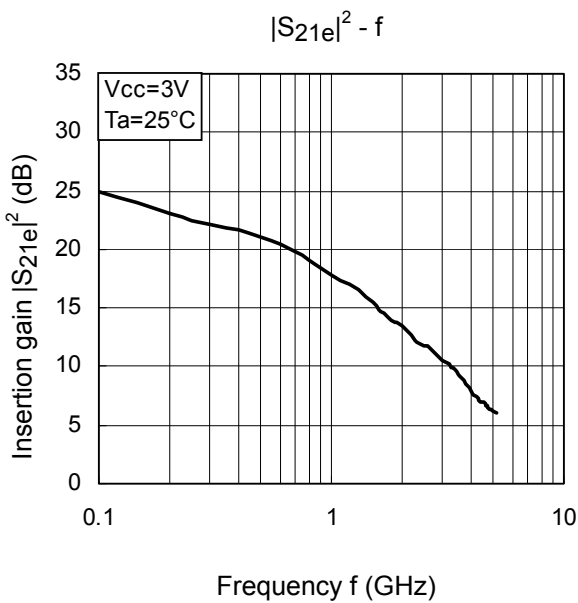
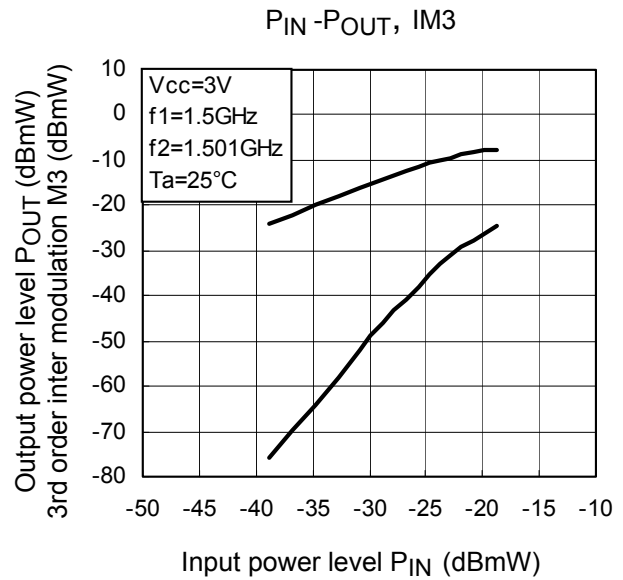
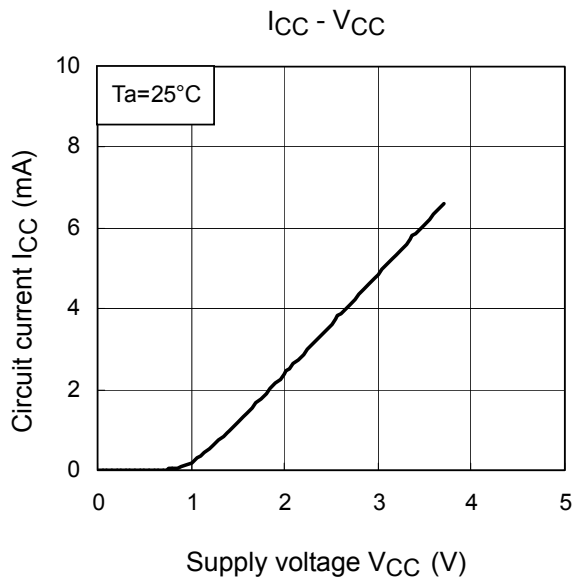

Notice

The circuits and measurements contained in this document are given only in the context of as examples of applications for these products.

Moreover, these example application circuits are not intended for mass production, since the high-frequency characteristics (the AC characteristics) of these devices will be affected by the external components which the customer uses, by the design of the circuit and by various other conditions.

It is the responsibility of the customer to design external circuits which correctly implement the intended application, and to check the characteristics of the design.

TOSHIBA assume no responsibility for the integrity of customer circuit designs or applications.

RESTRICTIONS ON PRODUCT USE

20070701-EN GENERAL

- The information contained herein is subject to change without notice.
- TOSHIBA is continually working to improve the quality and reliability of its products. Nevertheless, semiconductor devices in general can malfunction or fail due to their inherent electrical sensitivity and vulnerability to physical stress. It is the responsibility of the buyer, when utilizing TOSHIBA products, to comply with the standards of safety in making a safe design for the entire system, and to avoid situations in which a malfunction or failure of such TOSHIBA products could cause loss of human life, bodily injury or damage to property.
In developing your designs, please ensure that TOSHIBA products are used within specified operating ranges as set forth in the most recent TOSHIBA products specifications. Also, please keep in mind the precautions and conditions set forth in the "Handling Guide for Semiconductor Devices," or "TOSHIBA Semiconductor Reliability Handbook" etc.
- The TOSHIBA products listed in this document are intended for usage in general electronics applications (computer, personal equipment, office equipment, measuring equipment, industrial robotics, domestic appliances, etc.). These TOSHIBA products are neither intended nor warranted for usage in equipment that requires extraordinarily high quality and/or reliability or a malfunction or failure of which may cause loss of human life or bodily injury ("Unintended Usage"). Unintended Usage include atomic energy control instruments, airplane or spaceship instruments, transportation instruments, traffic signal instruments, combustion control instruments, medical instruments, all types of safety devices, etc.. Unintended Usage of TOSHIBA products listed in this document shall be made at the customer's own risk.
- The products described in this document shall not be used or embedded to any downstream products of which manufacture, use and/or sale are prohibited under any applicable laws and regulations.
- The information contained herein is presented only as a guide for the applications of our products. No responsibility is assumed by TOSHIBA for any infringements of patents or other rights of the third parties which may result from its use. No license is granted by implication or otherwise under any patents or other rights of TOSHIBA or the third parties.
- Please contact your sales representative for product-by-product details in this document regarding RoHS compatibility. Please use these products in this document in compliance with all applicable laws and regulations that regulate the inclusion or use of controlled substances. Toshiba assumes no liability for damage or losses occurring as a result of noncompliance with applicable laws and regulations.