



## Capsule Thyristor

## Line Thyristor

### SKT493

### Features

- Hermetic metal case with epoxy insulator
- Capsule package for double sided cooling
- Shallow design with single sided cooling
- Off-state and reverse voltages up to 1800 V
- Amplifying gate

### Typical Applications

- DC motor control (e. g. for machine tools)
- Controlled rectifiers (e. g. for battery charging)
- AC controllers (e. g. for temperature control)
- Soft Starters for AC motors

$V_{RSM}$ V	$V_{RRM}, V_{DRM}$ V	$I_{TRMS} = 1000$ A (maximum value for continuous operation) $I_{TAV} = 490$ A (sin. 180; DSC; $T_c = 80$ °C)	
500	400	SKT 493/04E	
900	800	SKT 493/08E	
1300	1200	SKT 493/12E	
1500	1400	SKT 493/14E	
1700	1600	SKT 493/16E	
1900	1800	SKT 493/18E	

Symbol	Conditions	Values	Units
$I_{TAV}$	sin. 180; $T_c = 100$ (85) °C;	321 (452)	A
$I_D$	2 x P8/180; $T_a = 45$ °C; B2 / B6	320 / 450	A
	2 x P8/180 F; $T_a = 35$ °C; B2 / B6	760 / 1000	A
$I_{RMS}$	2 x P8/180; $T_a = 45$ °C; W1C	350	A
$I_{TSM}$	$T_{vj} = 25$ °C; 10 ms	8000	A
	$T_{vj} = 125$ °C; 10 ms	7000	A
$i^2t$	$T_{vj} = 25$ °C; 8,3 ... 10 ms	320000	A <sup>2</sup> s
	$T_{vj} = 125$ °C; 8,3 ... 10 ms	245000	A <sup>2</sup> s
$V_T$	$T_{vj} = 25$ °C; $I_T = 1500$ A	max. 2,1	V
$V_{T(TO)}$	$T_{vj} = 125$ °C	max. 1,1	V
$r_T$	$T_{vj} = 125$ °C	max. 0,7	mΩ
$I_{DD}, I_{RD}$	$T_{vj} = 125$ °C; $V_{RD} = V_{RRM}; V_{DD} = V_{DRM}$	max. 50	mA
$t_{gd}$	$T_{vj} = 25$ °C; $I_G = 1$ A; $di_G/dt = 1$ A/μs	1	μs
$t_{gr}$	$V_D = 0,67 * V_{DRM}$	1	μs
$(di/dt)_{cr}$	$T_{vj} = 125$ °C	max. 125	A/μs
$(dv/dt)_{cr}$	$T_{vj} = 125$ °C	max. 1000	V/μs
$t_q$	$T_{vj} = 125$ °C,	50 ... 150	μs
$I_H$	$T_{vj} = 25$ °C; typ. / max.	150 / 500	mA
$I_L$	$T_{vj} = 25$ °C; $R_G = 33$ Ω; typ. / max.	500 / 2000	mA
$V_{GT}$	$T_{vj} = 25$ °C; d.c.	min. 3	V
$I_{GT}$	$T_{vj} = 25$ °C; d.c.	min. 250	mA
$V_{GD}$	$T_{vj} = 125$ °C; d.c.	max. 0,25	V
$I_{GD}$	$T_{vj} = 125$ °C; d.c.	max. 10	mA
$R_{th(j-c)}$	cont.; DSC	0,045	K/W
$R_{th(j-c)}$	sin. 180; DSC / SSC	0,047 / 0,1	K/W
$R_{th(j-c)}$	rec. 120; DSC / SSC	0,054 / 0,113	K/W
$R_{th(c-s)}$	DSC / SSC	0,012 / 0,024	K/W
$T_{vj}$		- 40 ... + 125	°C
$T_{stg}$		- 40 ... + 130	°C
$V_{isol}$		-	V~
F	mounting force	5,2 ... 8	kN
a			m/s <sup>2</sup>
m	approx.	85	g
Case		B 11a	

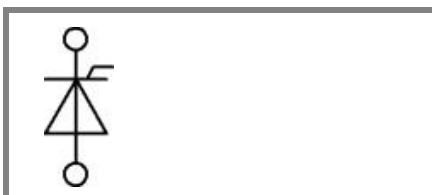

SKT

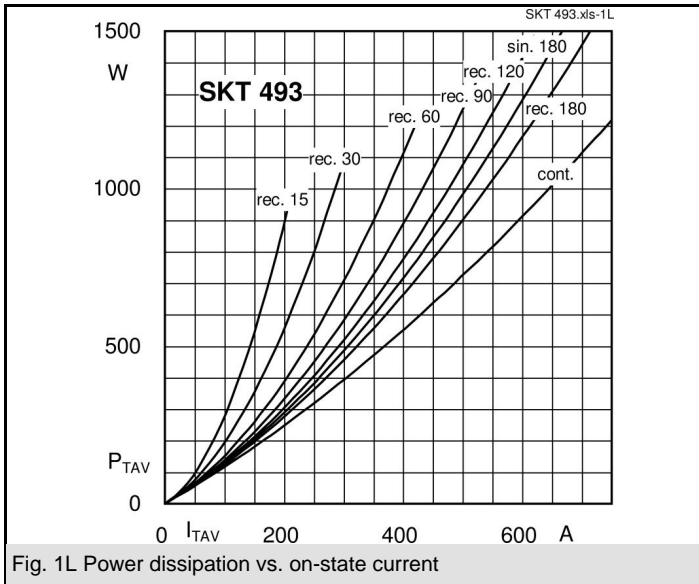

Fig. 1L Power dissipation vs. on-state current

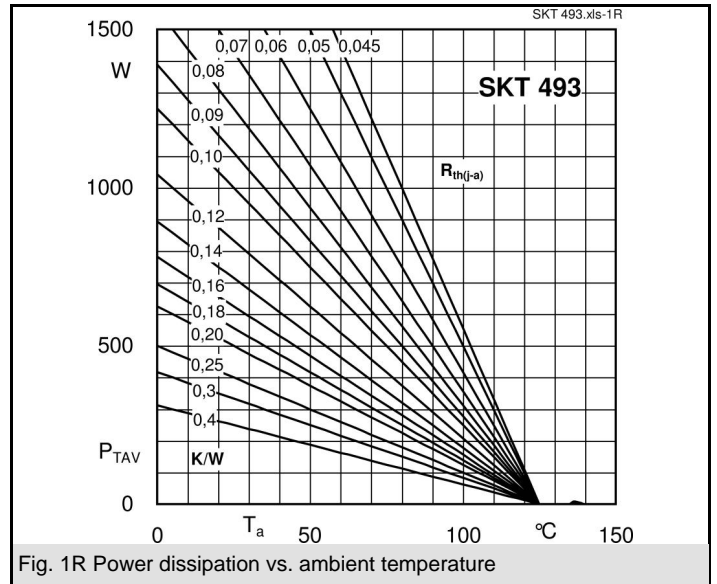

Fig. 1R Power dissipation vs. ambient temperature

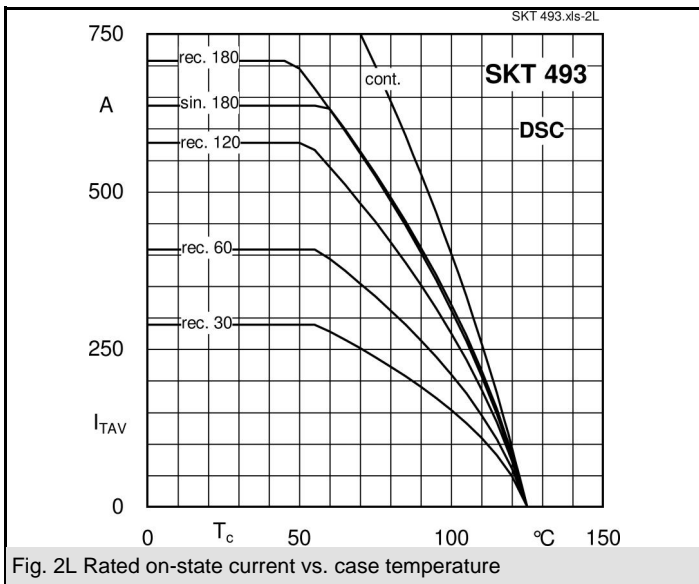

Fig. 2L Rated on-state current vs. case temperature

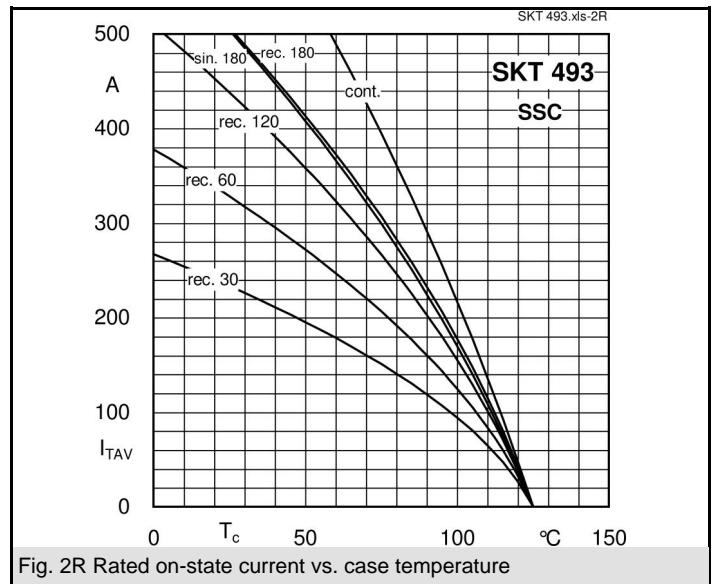

Fig. 2R Rated on-state current vs. case temperature

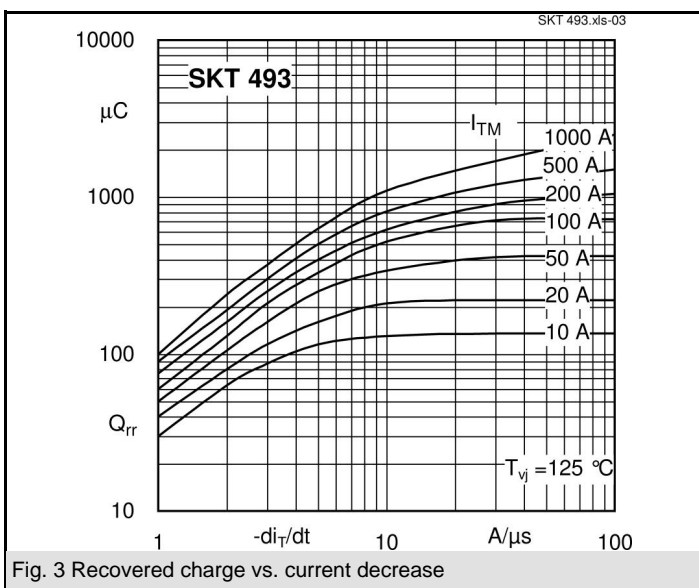

Fig. 3 Recovered charge vs. current decrease

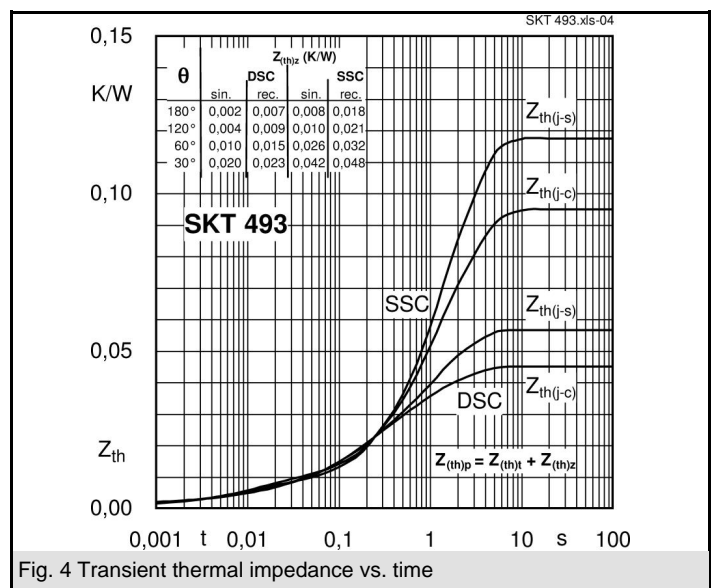
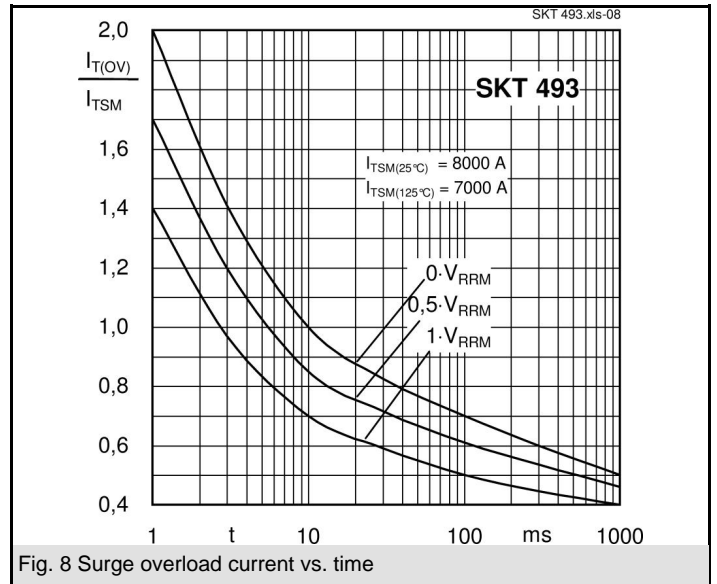
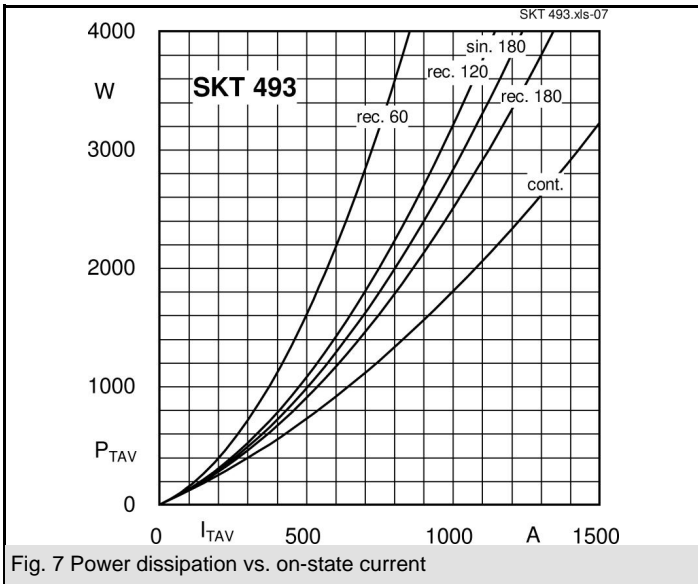
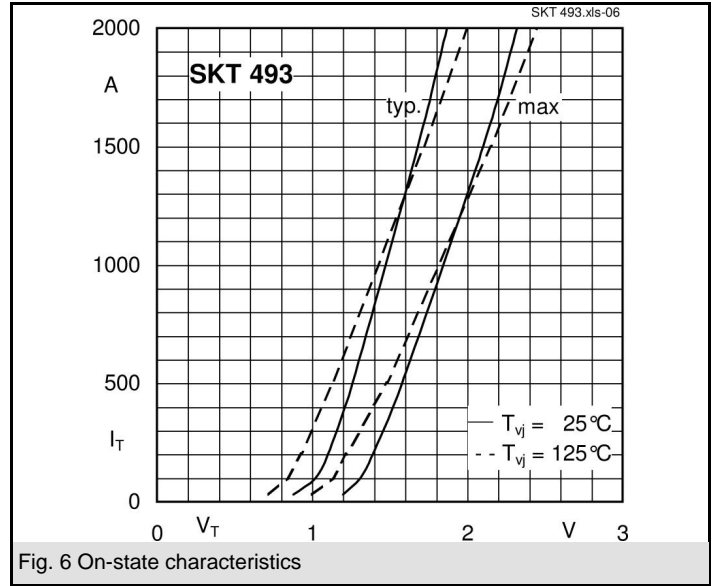
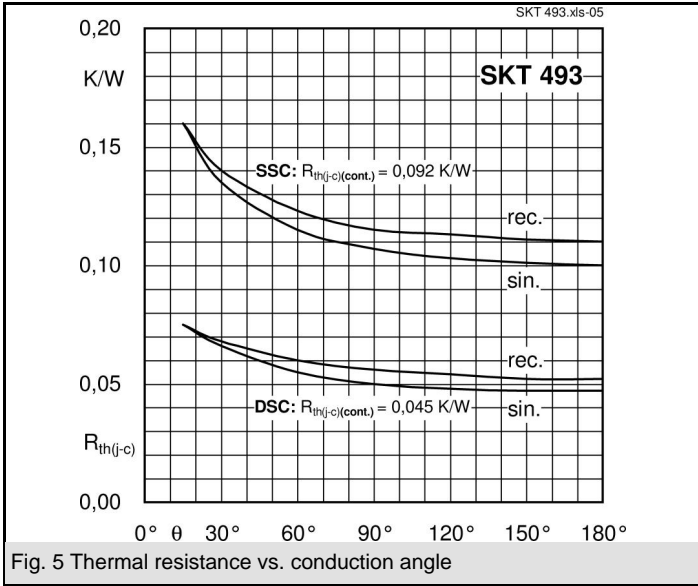
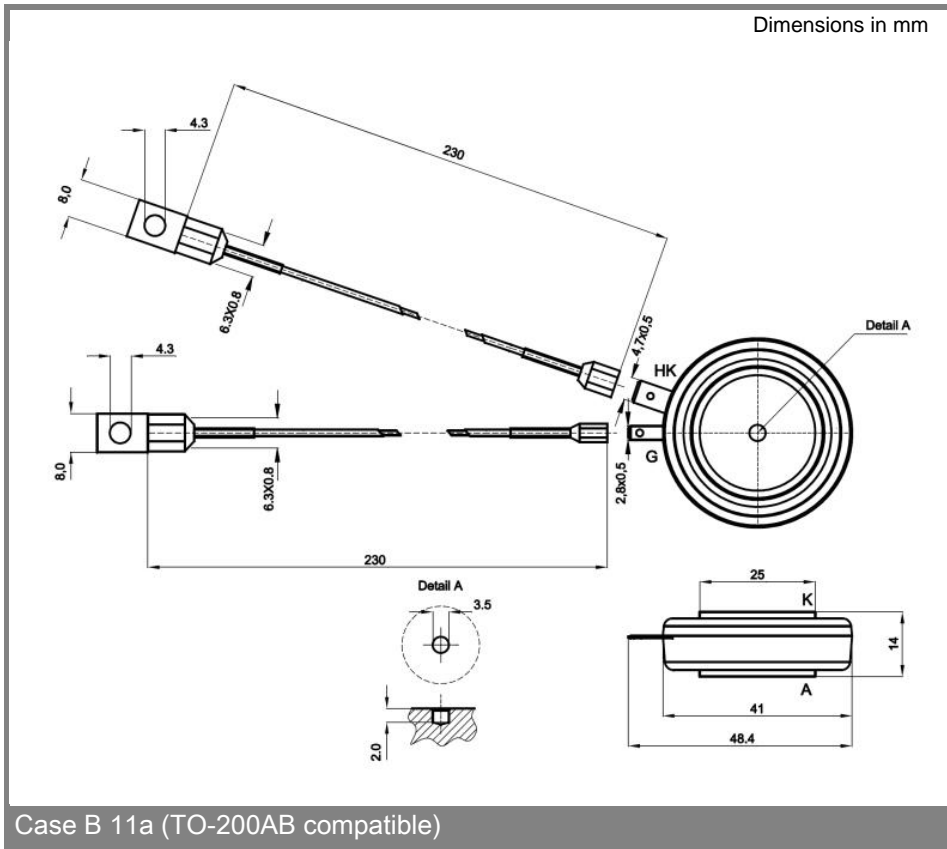
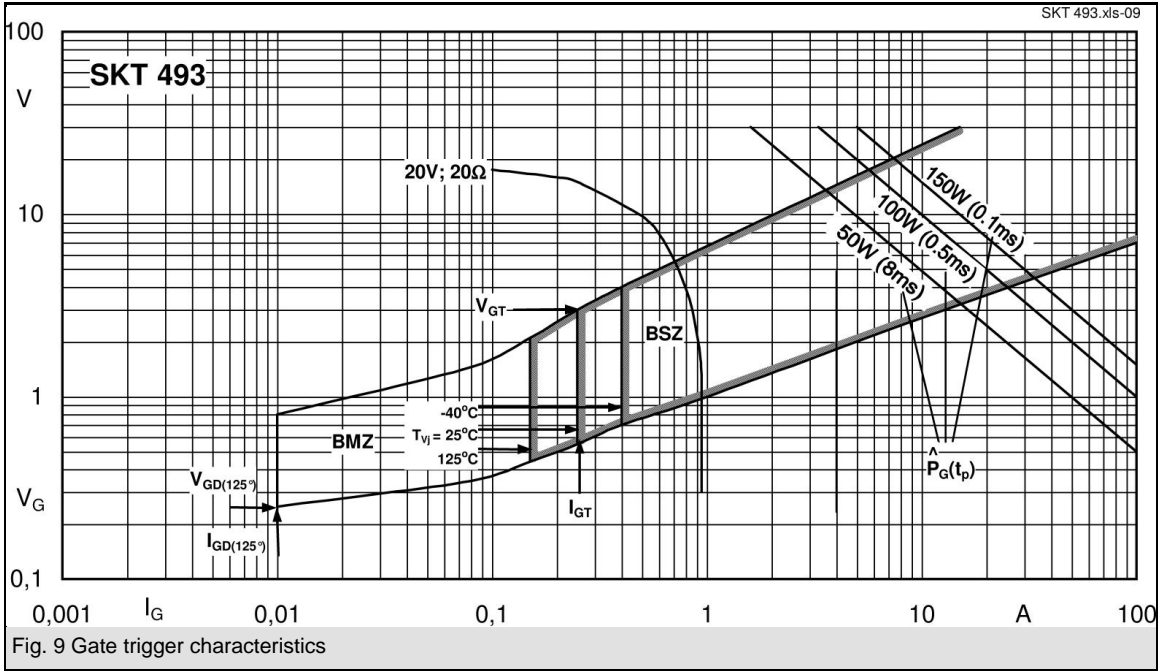

Fig. 4 Transient thermal impedance vs. time





This technical information specifies semiconductor devices but promises no characteristics. No warranty or guarantee expressed or implied is made regarding delivery, performance or suitability.