

**RoHS** **MLN SurgeArray™ Suppressor**

The MLN SurgeArray™ Suppressor is designed to help protect components from transient voltages that exist at the circuit board level. This device provides four independent suppressors in a single leadless chip in order to reduce part count and placement time as well as save space on printed circuit boards.

SurgeArray™ devices are intended to suppress ESD, EFT and other transients in order to protect integrated circuits or other sensitive components operating at any voltage up to 18V<sub>DC</sub>. SurgeArray devices are rated to the IEC 61000-4-2 human body model ESD to help products attain EMC compliance. The array offers excellent isolation and low crosstalk between sections.

The inherent capacitance of the SurgeArray Suppressor permits it to function as a filter/suppressor, thereby replacing separate zener/capacitor combinations.

The MLN array is manufactured using the Littelfuse Multilayer technology process and is similar to the Littelfuse ML and MLE Series of discrete leadless chips.

The MLN can also be provided in a Dual version. Contact Littelfuse for information.

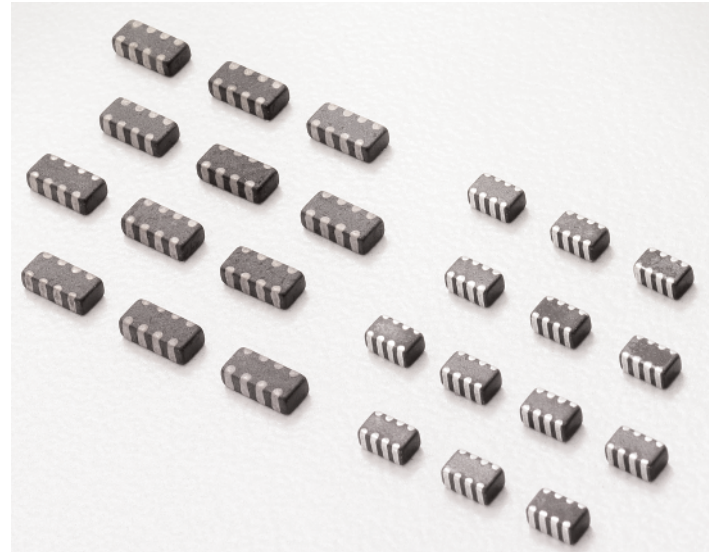

**Features**

- RoHS Compliant
- Four Individual Devices in One Chip
- ESD Rated to IEC 61000-4-2 (Level 4)
- AC Characterized for Impedance and Capacitance
- Low Adjacent Channel Crosstalk, -55dB at 10MHz (Typ)
- Low Leakage
- Operating Voltage up to 18V<sub>M(DC)</sub>
- -55°C to 125°C Operating Temperature Range
- Low-Profile, PCMCIA Compatible

**Applications**

- Data, Diagnostic I/O Ports
- Analog Signal/Sensor Lines
- Portable/Hand-Held Products
- Mobile Communications/Cellular Phones
- Computer/DSP Products
- Industrial Instruments Including Medical

**Size**

Metric	EIA
2012	0805
3216	1206

Multiline Transient Voltage Surge Suppressor



# MLN SurgeArray™ Suppressor

**Absolute Maximum Ratings** For ratings of individual members of a series, see device ratings and specifications table.

Continuous:

Steady State Applied Voltage: DC Voltage Range ( $V_{M(DC)}$ )	..... 18	V
Operating Ambient Temperature Range ( $T_A$ )	..... -55 to 125	°C
Storage Temperature Range ( $T_{STG}$ )	..... -55 to 150	°C

**Device Ratings and Specifications Any Single Section**

PART NUMBER	MAX RATINGS (125°C)			PERFORMANCE SPECIFICATIONS (25°C)							
	MAXIMUM CONTINUOUS WORKING VOLTAGE	MAXIMUM NON-REPETITIVE SURGE CURRENT (8/20 $\mu$ s)	MAXIMUM NON-REPETITIVE SURGE ENERGY (10/1000 $\mu$ s)	MAXIMUM CLAMPING VOLTAGE (AT NOTED 8/20 $\mu$ s) CURRENT	TYPICAL ESD SUPPRESSION VOLTAGE (NOTE 1)		NOMINAL VOLTAGE AT 1mA DC CURRENT		CAPACITANCE AT 1MHz (1V p-p)		
					(NOTE 2)		$V_{(DC)}$ MIN	$V_{(DC)}$ MAX	(NOTE 4)		
	8kV CONTACT	15kV AIR	TYP	MAX							
$V_{M(DC)}$	$I_{TM}$	$W_{TM}$	$V_C$	Peak	Clamp	Peak	(V)	(V)	(pF)	(pF)	
(V)	(A)	(J)	(V)	(V)	(V)	(V)	(V)	(V)	(pF)	(pF)	
<b>NEW</b> V5.5MLN40805	5.5	20	0.05	19 at 1A	140	40	90	7.1	10.8	220	300
V5.5MLN41206	5.5	30	0.1	15.5 at 2A	60	35	45	7.1	10.8	430	520
V9MLN41206	9	30	0.1	23 at 2A	95	50	75	11.0	16.0	250	300
V14MLN41206	14	30	0.1	30 at 2A	110	55	85	15.9	20.3	140	175
<b>NEW</b> V18MLN40805	18	20	0.05	50 at 1A	260	100	170	22.0	28.0	75	100
V18MLN41206	18	30	0.1	40 at 2A	165	63	100	22.0	28.0	100	125
V18MLN41206L	18	30	0.05	50 at 1A	200	95	130	25.0	35.0	45	75

NOTES:

1. Tested to IEC61000-4-2 Human Body Model (HBM) discharge test circuit.
2. Direct discharge to device terminals (IEC preferred test method).
3. Corona discharge through air (represents actual ESD event)
4. Capacitance may be customized, contact Sales.

## Temperature Derating

For applications exceeding 125°C ambient temperature, the peak surge current and energy ratings must be reduced as shown in Figure 1.

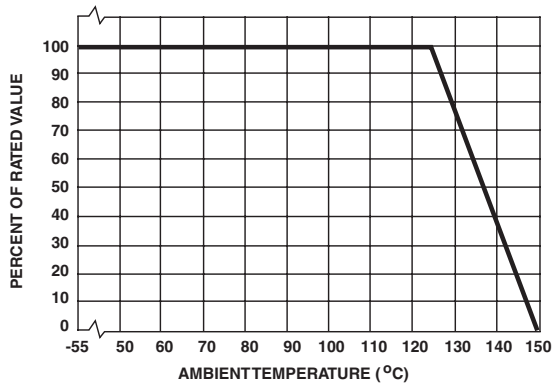
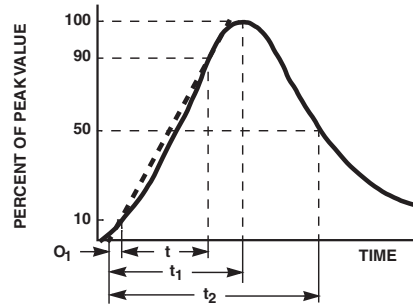

FIGURE 1. PEAK CURRENT AND ENERGY DERATING CURVE



$O_1$  = VIRTUAL ORIGIN OF WAVE  
 $t$  = TIME FROM 10% TO 90% OF PEAK  
 $t_1$  = VIRTUAL FRONT TIME =  $1.25 \times t$   
 $t_2$  = VIRTUAL TIME TO HALFVALUE (IMPULSE DURATION)

EXAMPLE:  
 FOR AN 8/20 $\mu$ s CURRENT WAVEFORM:  
 $8\mu$ s =  $t_1$  = VIRTUAL FRONT TIME  
 $20\mu$ s =  $t_2$  = VIRTUAL TIME TO HALFVALUE

FIGURE 2. PEAK PULSE CURRENT TEST WAVEFORM FOR CLAMPING VOLTAGE

3  
SURFACE MOUNT VARISTORS

# Surface Mount Varistors

## Multiline Transient Voltage Surge Suppressor

### RoHS MLN SurgeArray™ Suppressor

#### Typical Performance Curves Any Single Section

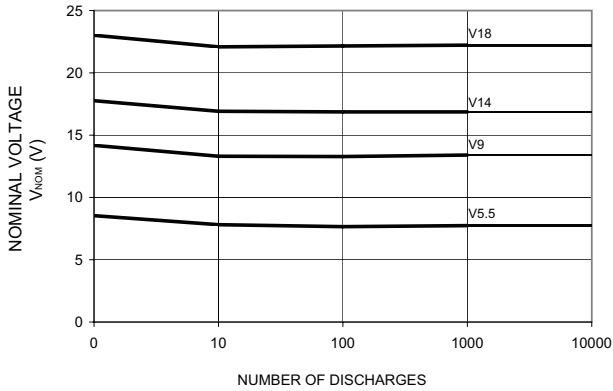

FIGURE 3. NOMINAL VOLTAGE STABILITY TO IEC 1000-4-2 (8kV CONTACT METHOD, ONE SECTION)

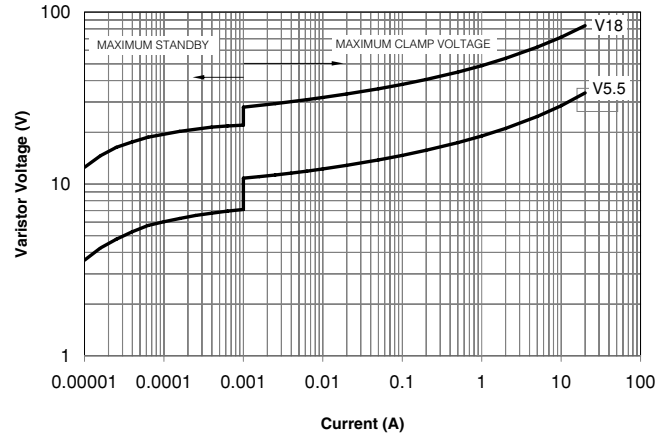

FIGURE 4. V-I CHARACTERISTIC, 0805 SIZE

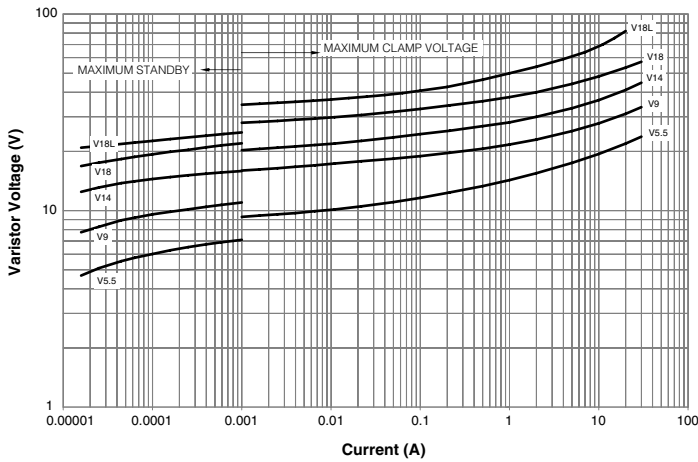

FIGURE 5. V-I CHARACTERISTIC, 1206 SIZE

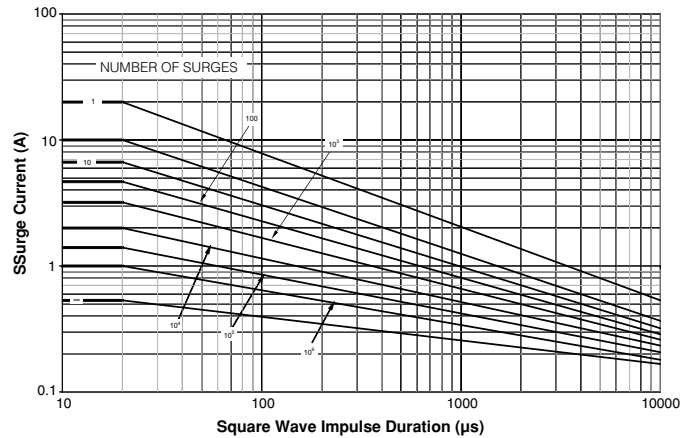

FIGURE 6. 0805 SIZE PULSE RATING FOR LONG DURATION SURGES (ANY SINGLE SECTION)

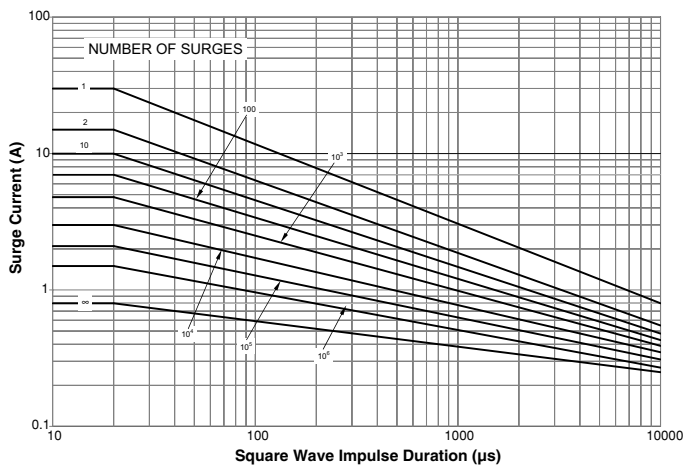

FIGURE 7. 1206 SIZE PULSE RATING FOR LONG DURATION SURGES (ANY SINGLE SECTION)

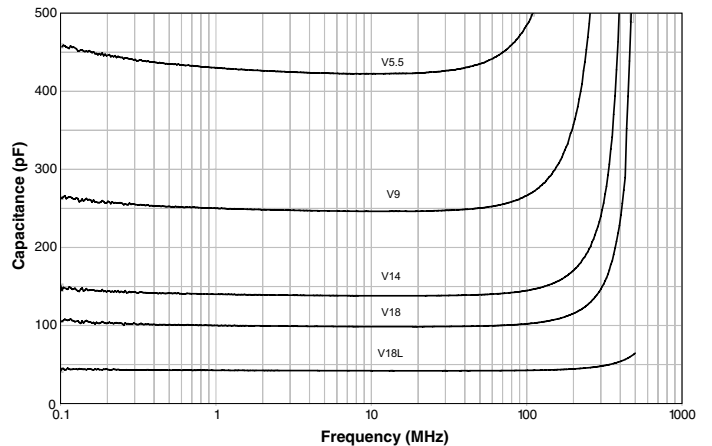

FIGURE 8. CAPACITANCE vs FREQUENCY

**RoHS** MLN SurgeArray™ Suppressor

**Typical Performance Curves** Any Single Section (Continued)

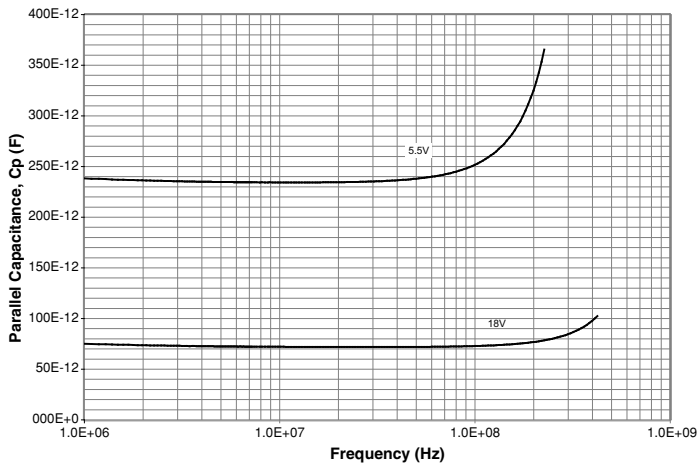

FIGURE 9. CAPACITANCE VS. FREQUENCY, 0805 SIZE

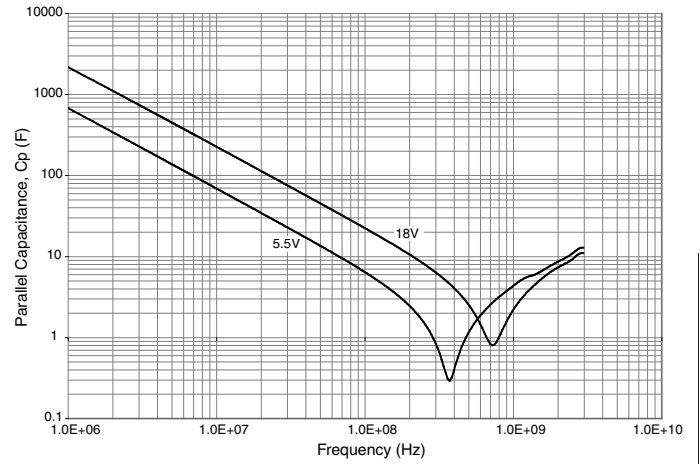

FIGURE 10. IMPEDANCE VS FREQUENCY, 0805 SIZE

SURFACE MOUNT VARISTORS

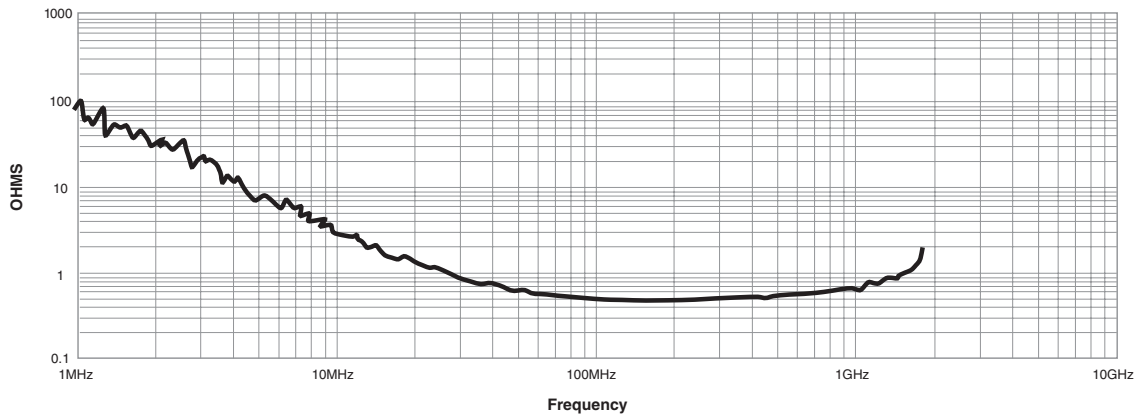

FIGURE 11. CAPACITANCE VS FREQUENCY, 1206 SIZE

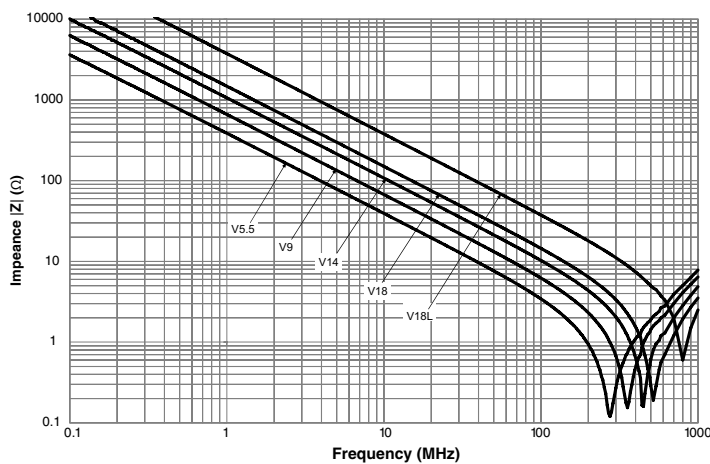

FIGURE 12. IMPEDANCE vs FREQUENCY, 1206 SIZE

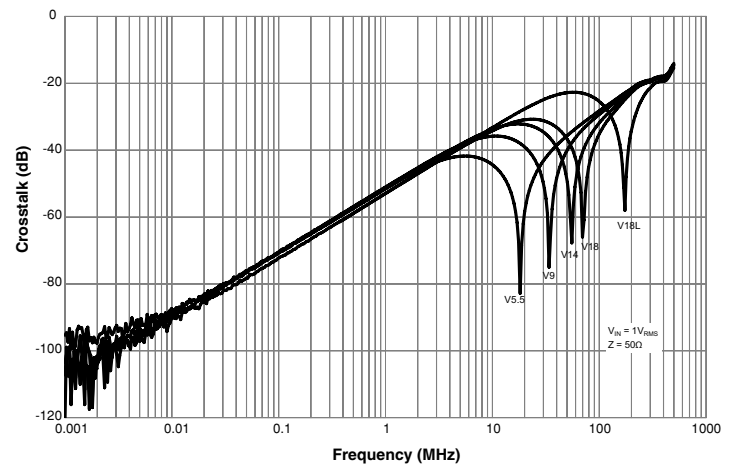

FIGURE 13. ADJACENT CHANNEL CROSSTALK

## RoHS MLN SurgeArray™ Suppressor

### Soldering Recommendations

#### Lead (Pb) Soldering Recommendations

The principal techniques used for the soldering of components in surface mount technology are IR Re-flow & Wave soldering. Typical profiles are shown in Figures 14 & 15

The recommended solder for the MLN SurgeArray suppressor is a 62/36/2 (Sn/Pb/Ag), 60/40 (Sn/Pb) or 63/37 (Sn/Pb). Littelfuse also recommends an RMA solder flux.

Wave soldering is the most strenuous of the processes. To avoid the possibility of generating stresses due to thermal shock, a preheat stage in the soldering process is recommended, and the peak temperature of the solder process should be rigidly controlled.

When using a reflow process, care should be taken to ensure that the MLN chip is not subjected to a thermal gradient steeper than 4 degrees per second; the ideal gradient being 2 degrees per second. During the soldering process, preheating to within 100 degrees of the solder's peak temperature is essential to minimize thermal shock.

Once the soldering process has been completed, it is still necessary to ensure that any further thermal shocks are avoided. One possible cause of thermal shock is hot printed circuit boards being removed from the solder process and subjected to cleaning solvents at room temperature. The boards must be allowed to cool gradually to less than 50°C before cleaning.

#### Lead-Free (Pb-free) Soldering Recommendations

Littelfuse offers the 0805 array as the preferred solution for lead-free soldering conditions.

The preferred solder is 96.5/3.0/0.5 (SnAgCu) with an RMA flux, but there is a wide selection of pastes & fluxes available with which the nickel barrier parts should be compatible.

The reflow profile must be constrained by maximums shown in Figure 16. For Pb-free Wave soldering, Figure 15 still applies.

Note: the Pb-free paste, flux & profile were used for evaluation purposes by Littelfuse, based upon industry standards & practices. There are multiple choices of all three available, it is advised that the customer explores the optimum combination for their process as processes vary considerably from site to site.

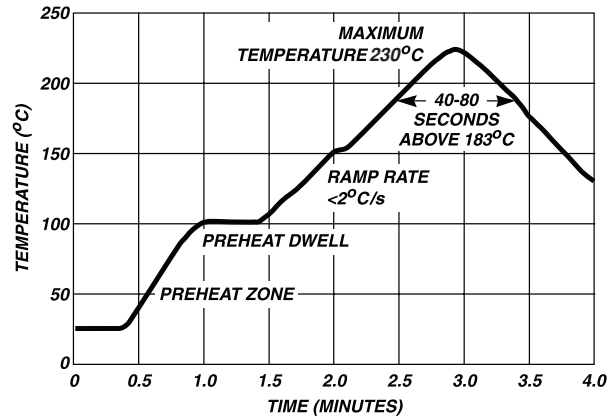

FIGURE 14. REFLOW SOLDER PROFILE

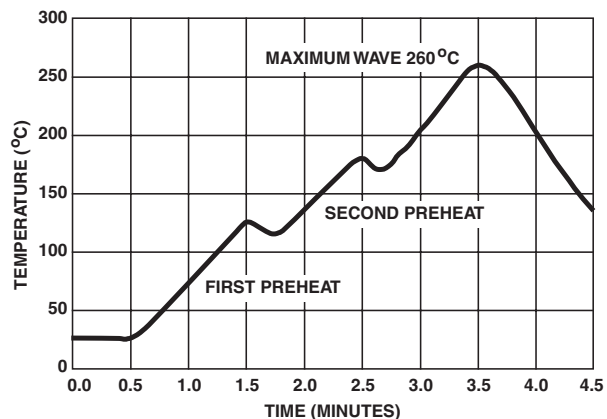

FIGURE 15. WAVE SOLDER PROFILE

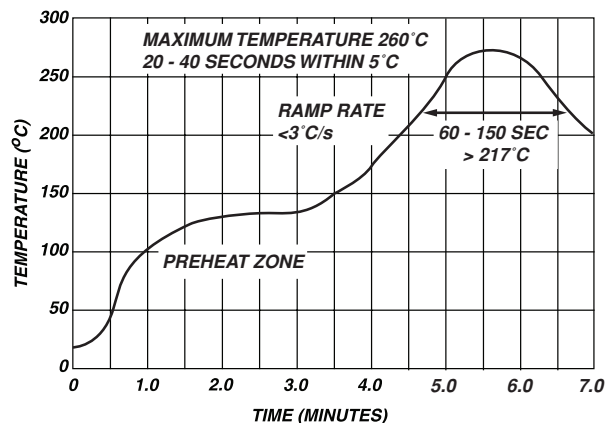
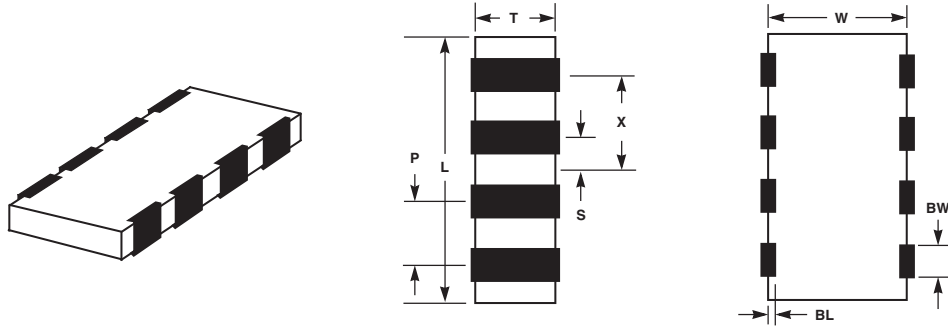

FIGURE 16. LEAD-FREE RE-FLOW SOLDER PROFILE

**RoHS** MLN SurgeArray™ Suppressor

**Mechanical Dimensions**



Size	Units	L	W	T	BW	BL	P	X	S
0805	Inch	0.080 ±0.008	0.050 ±0.008	0.038 Max	0.012 ±0.004	0.007 +0.01/- 0.002	0.020 Ref	0.030 ±0.004	0.010 ±0.004
	Millimeter	2.03 ±0.2	1.27 ±0.2	1.10 Max	0.30 ±0.1	0.18 +0.25/-0.05	0.508 Ref	0.76 ±0.1	0.254 ±0.1
1206	Inch	0.126 ±0.008	0.063 ±0.008	0.053 Max	0.016 ±0.004	0.007 +0.01/- 0.002	0.030 Ref	0.045 ±0.004	0.015 ±0.004
	Millimeter	3.2 ±0.2	1.6 ±0.2	1.35 Max	0.41 ±0.1	0.18 +0.25/-0.05	0.76 Ref	1.14 ±0.1	0.38 ±0.1

**Recommended Pad Outline**

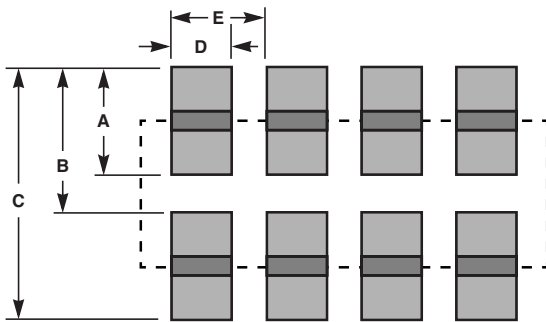

TABLE 1. PAD LAYOUT DIMENSIONS

Size	Units	A	B	C	D	E
0805	Millimeters	0.90	1.30	2.20	0.35	0.50
	Inches	0.035	0.051	0.087	0.014	0.02
1206	Millimeters	0.89	1.65	2.54	0.46	0.79
	Inches	0.035	0.065	0.100	0.018	0.030

3 SURFACE MOUNT VARISTORS

# RoHS MLN SurgeArray™ Suppressor

## Ordering Information

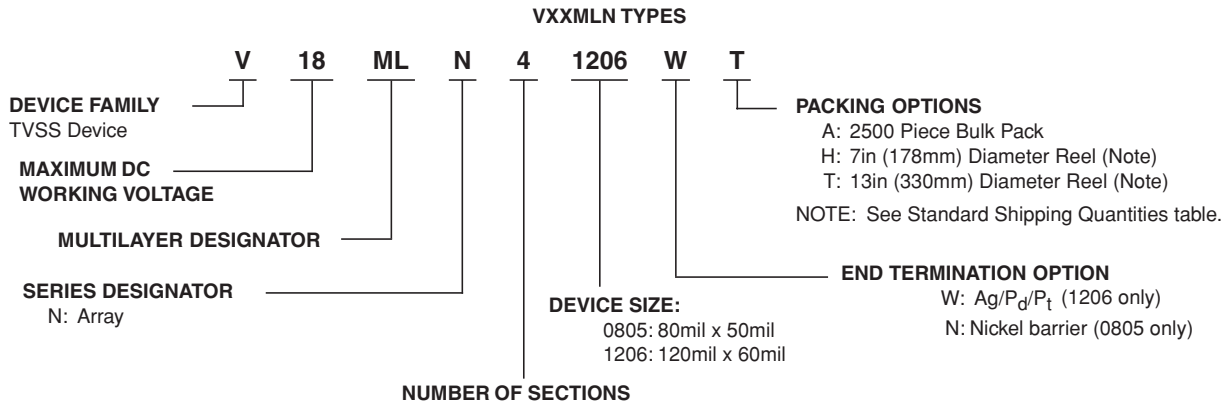

## Tape and Reel Specifications

- Conforms to EIA - 481, Revision A
- Can be Supplied to IEC Publication 286 - 3

SYMBOL	DESCRIPTION	MILLIMETERS
A <sub>0</sub>	Width of Cavity	Dependent on Chip Size to Minimize Rotation.
B <sub>0</sub>	Length of Cavity	Dependent on Chip Size to Minimize Rotation.
K <sub>0</sub>	Depth of Cavity	Dependent on Chip Size to Minimize Rotation.
W	Width of Tape	8 ±0.2
F	Distance Between Drive Hole Centers and Cavity Centers	3.5 ±0.5
E	Distance Between Drive Hole Centers and Tape Edge	1.75 ±0.1
P <sub>1</sub>	Distance Between Cavity Center	4 ±0.1
P <sub>2</sub>	Axial Distance Between Drive Hole Centers and Cavity Centers	2 ±0.1
P <sub>0</sub>	Axial Distance Between Drive Hole Centers	4 ±0.1
D <sub>0</sub>	Drive Hole Diameter	1.55 ±0.05
D <sub>1</sub>	Diameter of Cavity Piercing	1.05 ±0.05
t <sub>1</sub>	Embossed Tape Thickness	0.3 Max
t <sub>2</sub>	Top Tape Thickness	0.1 Max

NOTE: Dimensions in millimeters.

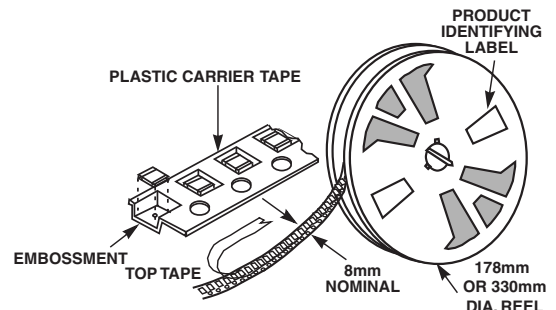
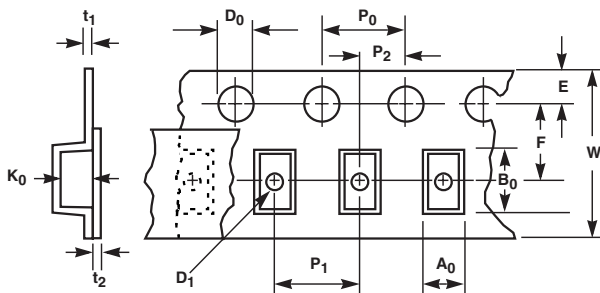

## Standard Shipping Quantities

DEVICE SIZE	"13" INCH REEL ("T" OPTION)	"7" INCH REEL ("H" OPTION)	BULK PACK ("A" OPTION)
0805 and 1206	10,000	2,500	2,500