

Infrared LED

L6437 series

High radiant output GaAs LED with position reference hole

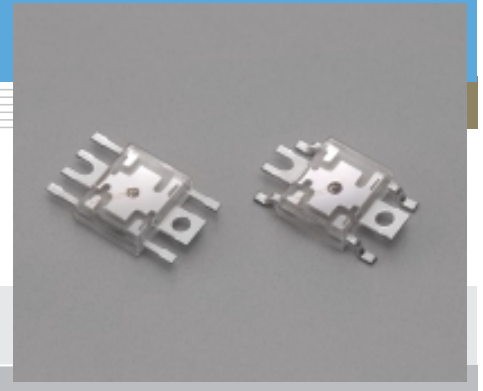

Features

- Lead frame package with position reference hole
- Small package
- High radiant output power

Applications

- Auto-focus
- Optical switch

■ Absolute maximum ratings (Ta=25 °C)

Parameter	Symbol	Condition	Value	Unit
Forward current	IF		65	mA
Reverse voltage	VR		5	V
Pulse forward current	IFP	Pulse width=10 μs Duty ratio=1 %	1.0	A
Operating temperature	Topr		-25 to +80	°C
Storage temperature	Tstg		-30 to +100	°C

■ Electrical and optical characteristics (Ta=25 °C)

Parameter	Symbol	Condition	Min.	Typ.	Max.	Unit
Peak emission wavelength	λ_p	IF=50 mA	920	945	970	nm
Spectral half width	$\Delta\lambda$	IF=50 mA	-	60	-	nm
Forward voltage	VF	IF=50 mA	-	1.35	1.45	V
Pulse forward voltage	VFP	IF=1.0 A	-	2.5	3.1	V
Reverse current	IR	VR=5 V	-	-	20	μA
Radiant flux	ϕ_e	IF=50 mA	7.0	10.0	-	mW
Radiant illuminance	PE	IF=50 mA	-	0.5	-	mW/cm ²
Rise time	tr	IF=50 mA, 10 to 90 %	-	2.0	3.0	μs
Fall time	tf	IF=50 mA, 90 to 10 %	-	1.0	2.0	μs

■ Emission spectrum

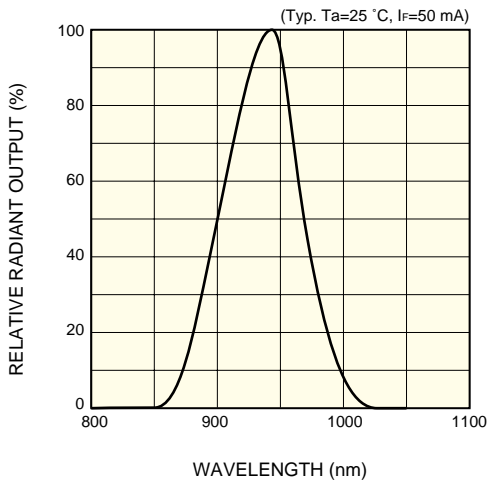

KLEDB0181EA

■ Radiant flux vs. forward current

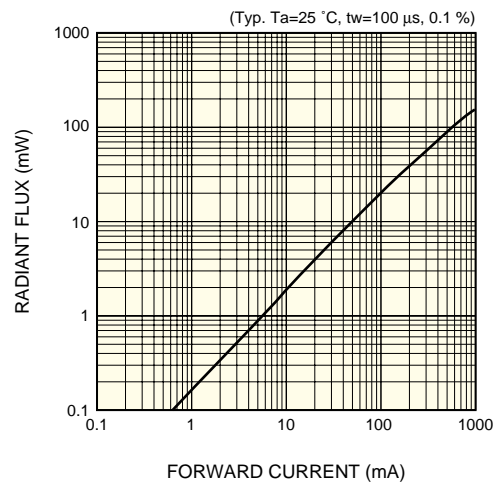

KLEDB0182EA

■ Forward current vs. forward voltage

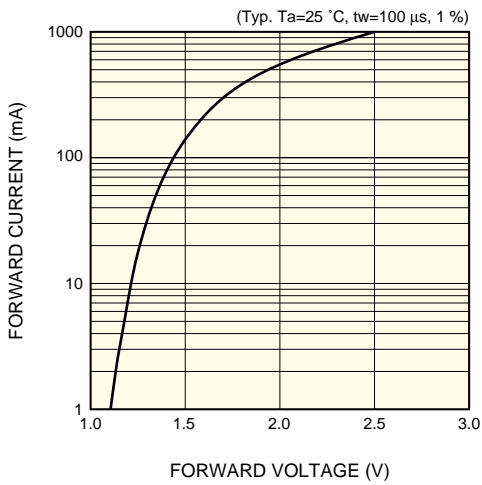

KLEDB0183EA

■ Directivity

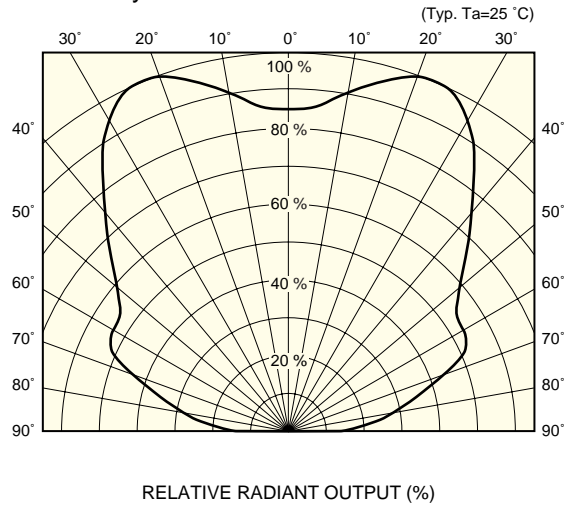

KLEDB0071EB

■ Radiant output vs. ambient temperature

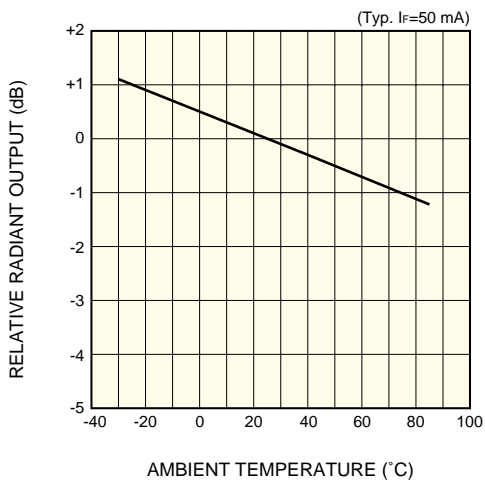

KLEDB0184EA

■ Allowable forward current vs. ambient temperature

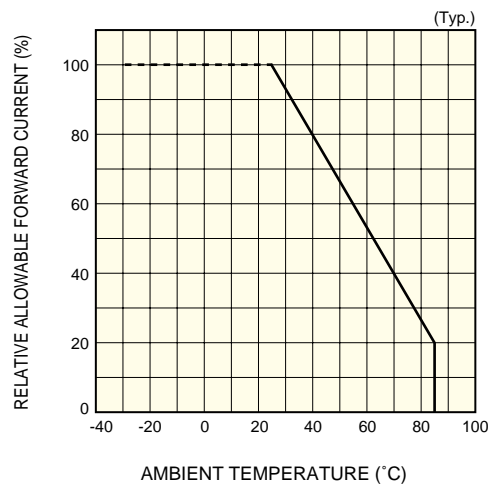

KLEDB0027EB

■ Allowable forward current vs. duty ratio

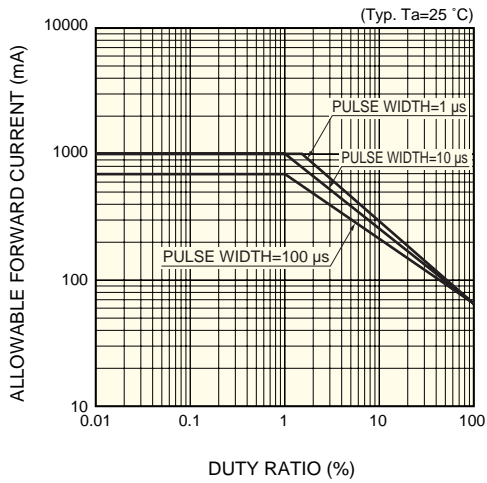

KLEDB0290EA

■ Dimensional outlines (unit: mm)

① L6437

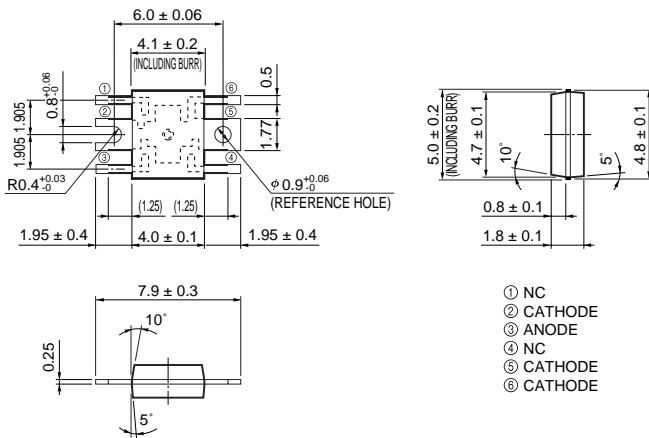

KLEDA0031EB

② L6437-01

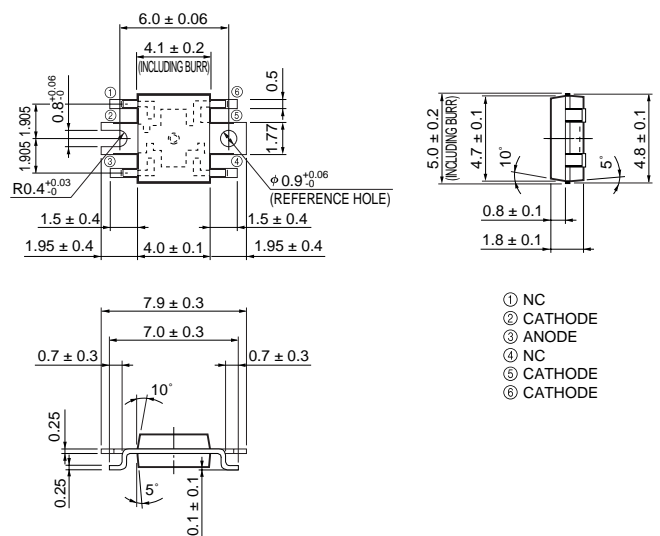

KLEDA0062EA

HAMAMATSU

Information furnished by HAMAMATSU is believed to be reliable. However, no responsibility is assumed for possible inaccuracies or omissions. Specifications are subject to change without notice. No patent rights are granted to any of the circuits described herein. ©2006 Hamamatsu Photonics K.K.

HAMAMATSU PHOTONICS K.K., Solid State Division

1126-1 Ichino-cho, Higashi-ku, Hamamatsu City, 435-8558 Japan, Telephone: (81) 53-434-3311, Fax: (81) 53-434-5184, www.hamamatsu.com

U.S.A.: Hamamatsu Corporation: 360 Foothill Road, P.O.Box 6910, Bridgewater, N.J. 08807-0910, U.S.A., Telephone: (1) 908-231-0960, Fax: (1) 908-231-1218

Germany: Hamamatsu Photonics Deutschland GmbH: Arzbergerstr. 10, D-82211 Herrsching am Ammersee, Germany, Telephone: (49) 08152-3750, Fax: (49) 08152-2658

France: Hamamatsu Photonics France S.A.R.L.: 19, Rue du Saule Trapu, Parc du Moulin de Massy, 91882 Massy Cedex, France, Telephone: 33-(1) 69 53 71 00, Fax: 33-(1) 69 53 71 10

United Kingdom: Hamamatsu Photonics UK Limited: 2 Howard Court, 10 Tewin Road, Welwyn Garden City, Hertfordshire AL7 1BW, United Kingdom, Telephone: (44) 1707-294888, Fax: (44) 1707-325777

North Europe: Hamamatsu Photonics Norden AB: Smidesvägen 12, SE-171 41 Solna, Sweden, Telephone: (46) 8-509-031-00, Fax: (46) 8-509-031-01

Italy: Hamamatsu Photonics Italia S.R.L.: Strada della Moia, 1/E, 20020 Arese, (Milano), Italy, Telephone: (39) 02-935-81-733, Fax: (39) 02-935-81-741