

PolarHV™ HiPerFET Power MOSFET

IXFK 48N60P
IXFX 48N60P

$V_{DSS} = 600 \text{ V}$
 $I_{D2} = 48 \text{ A}$
 $R_{DS(on)} \leq 135 \text{ m}\Omega$
 $t_{rr} \leq 200 \text{ ns}$

N-Channel Enhancement Mode
Avalanche Rated
Fast Intrinsic Diode

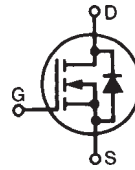

Symbol	Test Conditions	Maximum Ratings	
V_{DSS}	$T_J = 25^\circ \text{C}$ to 150°C	600	V
V_{DGR}	$T_J = 25^\circ \text{C}$ to 150°C ; $R_{GS} = 1 \text{ M}\Omega$	600	V
V_{GSS}	Continuous	± 30	V
V_{GSM}	Transient	± 40	V
I_{D25}	$T_C = 25^\circ \text{C}$	48	A
I_{DM}	$T_C = 25^\circ \text{C}$, pulse width limited by T_{JM}	110	A
I_{AR}	$T_C = 25^\circ \text{C}$	48	A
E_{AR}	$T_C = 25^\circ \text{C}$	70	mJ
E_{AS}	$T_C = 25^\circ \text{C}$	2.0	J
dv/dt	$I_S \leq I_{DM}$, $di/dt \leq 100 \text{ A}/\mu\text{s}$, $V_{DD} \leq V_{DSS}$, $T_J \leq 150^\circ \text{C}$, $R_G = 4 \Omega$	20	V/ns
P_D	$T_C = 25^\circ \text{C}$	830	W
T_J		-55 ... +150	$^\circ \text{C}$
T_{JM}		150	$^\circ \text{C}$
T_{stg}		-55 ... +150	$^\circ \text{C}$
M_d	Mounting torque (TO-264)	1.13/10 Nm/lb.in.	
Weight	TO-264	10	g
	PLUS247	6	g
T_L	1.6 mm (0.062 in.) from case for 10 s	300	$^\circ \text{C}$
T_{SOLD}	Plastic body for 10 s	260	$^\circ \text{C}$

Symbol	Test Conditions ($T_J = 25^\circ \text{C}$, unless otherwise specified)	Characteristic Values		
		Min.	Typ.	Max.
BV_{DSS}	$V_{GS} = 0 \text{ V}$, $I_D = 250 \mu\text{A}$	600		V
$V_{GS(th)}$	$V_{DS} = V_{GS}$, $I_D = 8 \text{ mA}$	3.0		5.0 V
I_{GSS}	$V_{GS} = \pm 30 \text{ V}_{DC}$, $V_{DS} = 0$			$\pm 200 \text{ nA}$
I_{DSS}	$V_{DS} = V_{DSS}$ $V_{GS} = 0 \text{ V}$ $T_J = 125^\circ \text{C}$			25 μA
				1000 μA
$R_{DS(on)}$	$V_{GS} = 10 \text{ V}$, $I_D = 0.5 I_{D25}$ Pulse test, $t \leq 300 \mu\text{s}$, duty cycle $d \leq 2 \%$			135 $\text{m}\Omega$

TO-264 (IXFK)

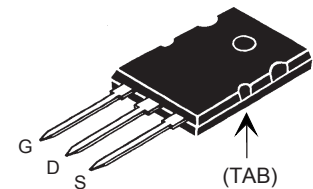

PLUS247 (IXFX)

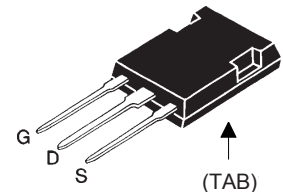

G = Gate D = Drain
S = Source Tab = Drain

Features

- † International standard packages
- † Fast recovery diode
- † Unclamped Inductive Switching (UIS) rated
- † Low package inductance
- easy to drive and to protect

Advantages

- † Easy to mount
- † Space savings
- † High power density

Symbol	Test Conditions	Characteristic Values		
		Min.	Typ.	Max.
g_{fs}	$V_{DS} = 20\text{ V}; I_D = 0.5 I_{D25}$, pulse test	35	53	S
C_{iss}	$V_{GS} = 0\text{ V}, V_{DS} = 25\text{ V}, f = 1\text{ MHz}$		8860	pF
C_{oss}			850	pF
C_{rss}			60	pF
$t_{d(on)}$	$V_{GS} = 10\text{ V}, V_{DS} = 0.5 I_{D25}$ $R_G = 2\ \Omega$ (External)		30	ns
t_r			25	ns
$t_{d(off)}$			85	ns
t_f			22	ns
$Q_{g(on)}$	$V_{GS} = 10\text{ V}, V_{DS} = 0.5 V_{DSS}, I_D = 0.5 I_{D25}$		150	nC
Q_{gs}			50	nC
Q_{gd}			50	nC
R_{thJC}	TO-264 and PLUS247			0.15 °C/W
R_{thCs}			0.15	°C/W

Symbol	Test Conditions	Characteristic Values		
		Min.	Typ.	Max.
I_S	$V_{GS} = 0\text{ V}$			48 A
I_{SM}	Repetitive			110 A
V_{SD}	$I_F = I_S, V_{GS} = 0\text{ V}$, Pulse test, $t \leq 300\ \mu\text{s}$, duty cycle $d \leq 2\%$			1.5 V
t_{rr}	$I_F = 25\text{ A}, -di/dt = 100\text{ A}/\mu\text{s}$ $V_R = 100\text{ V}$			200 ns
Q_{RM}			0.8	μC
I_{RM}			6.0	A

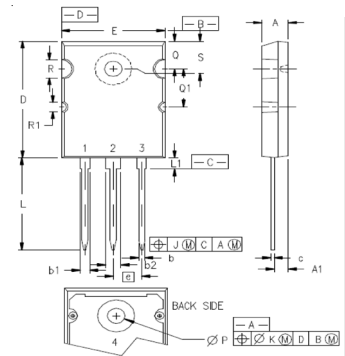
TO-264 (IXFK) Outline

- 1 - GATE
2, 4 - DRAIN (COLLECTOR)
3 - SOURCE (EMITTER)

SYM	INCHES		MILLIMETERS	
	MIN	MAX	MIN	MAX
A	.185	.209	4.70	5.31
A1	.102	.118	2.59	3.00
b	.037	.055	0.94	1.40
b1	.087	.102	2.21	2.59
b2	.110	.126	2.79	3.20
c	.017	.029	0.43	0.74
D	1.007	1.047	25.58	26.59
E	.760	.799	19.30	20.29
e	.215 BSC		5.46 BSC	
J	.000	.010	0.00	0.25
K	.000	.010	0.00	0.25
L	.779	.842	19.79	21.39
L1	.087	.102	2.21	2.59
ØP	.122	.138	3.10	3.51
Q	.240	.256	6.10	6.50
Q1	.330	.346	8.38	8.79
ØR	.155	.187	3.94	4.75
ØR1	.085	.093	2.16	2.36
S	.243	.253	6.17	6.43

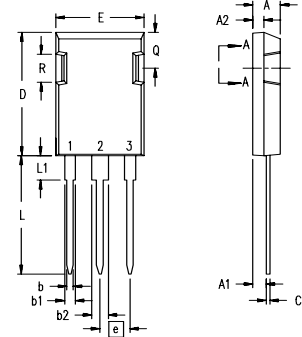
PLUS 247™ (IXFX) Outline

- Terminals: 1 - Gate
2 - Drain (Collector)
3 - Source (Emitter)
4 - Drain (Collector)

Dim.	Millimeter		Inches	
	Min.	Max.	Min.	Max.
A	4.83	5.21	.190	.205
A ₁	2.29	2.54	.090	.100
A ₂	1.91	2.16	.075	.085
b	1.14	1.40	.045	.055
b ₁	1.91	2.13	.075	.084
b ₂	2.92	3.12	.115	.123
C	0.61	0.80	.024	.031
D	20.80	21.34	.819	.840
E	15.75	16.13	.620	.635
e	5.45 BSC		.215 BSC	
L	19.81	20.32	.780	.800
L1	3.81	4.32	.150	.170
Q	5.59	6.20	.220	0.244
R	4.32	4.83	.170	.190

IXYS reserves the right to change limits, test conditions, and dimensions.

IXYS MOSFETs and IGBTs are covered by 4,835,592 4,931,844 5,049,961 5,237,481 6,162,665 6,404,065 B1 6,683,344 6,727,585
one or more of the following U.S. patents: 4,850,072 5,017,508 5,063,307 5,381,025 6,259,123 B1 6,534,343 6,710,405 B2 6,759,692
4,881,106 5,034,796 5,187,117 5,486,715 6,306,728 B1 6,583,505 6,710,463 6,771,478 B2

**Fig. 1. Output Characteristics
@ 25°C**

**Fig. 2. Extended Output Characteristics
@ 25°C**

**Fig. 3. Output Characteristics
@ 125°C**

**Fig. 4. $R_{DS(on)}$ Normalized to 0.5 I_{D25}
Value vs. Junction Temperature**

**Fig. 5. $R_{DS(on)}$ Normalized to
0.5 I_{D25} Value vs. I_D**

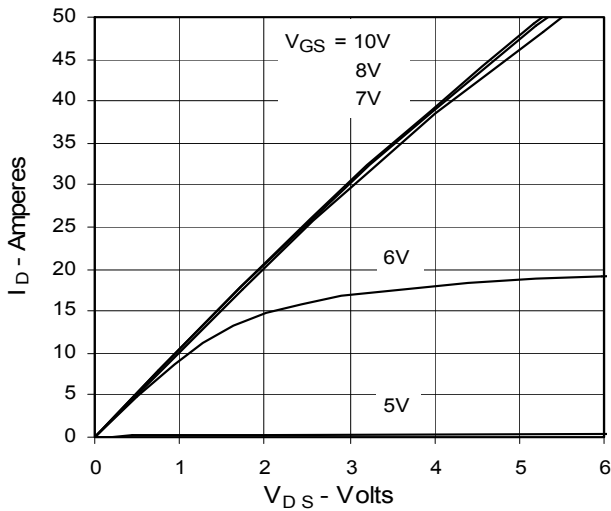
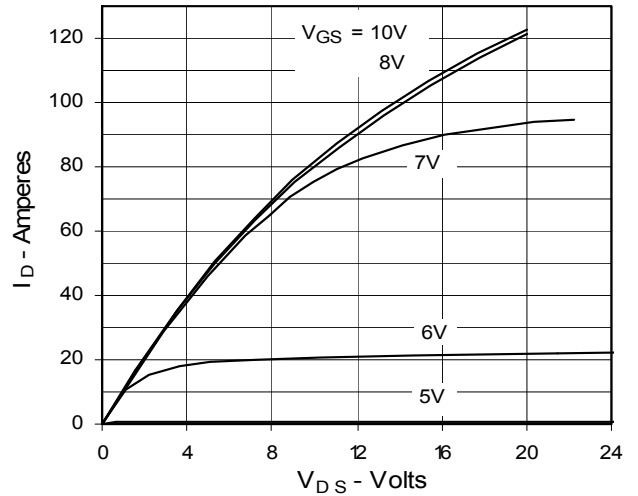
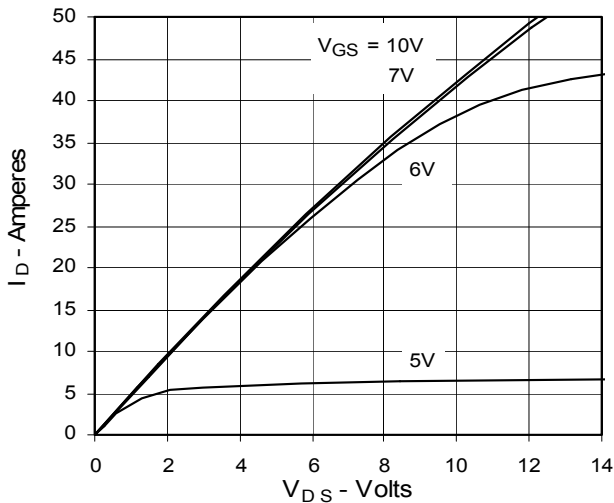
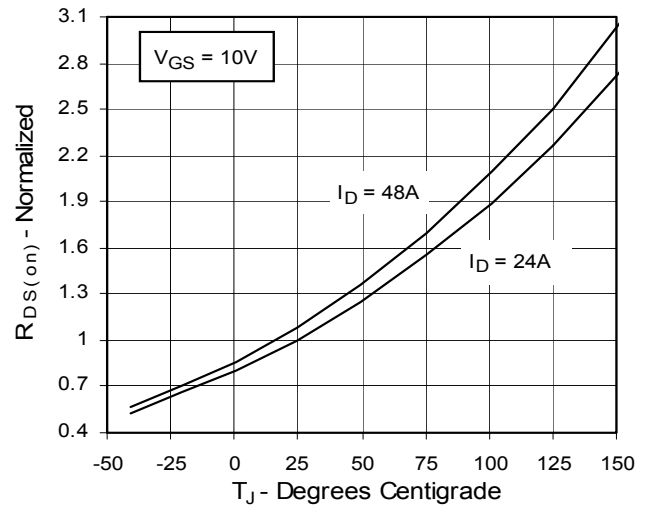
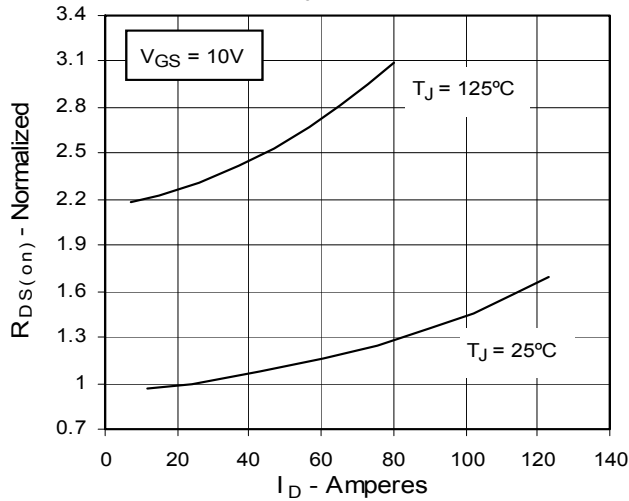
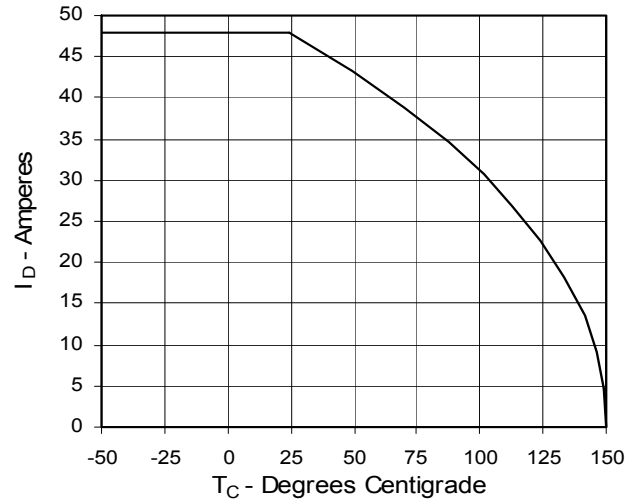
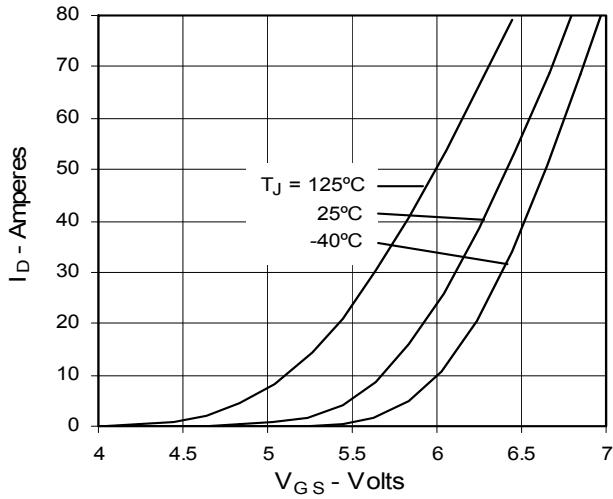
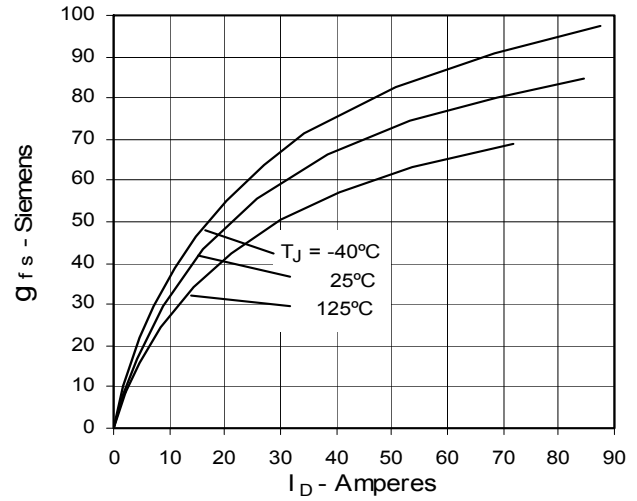
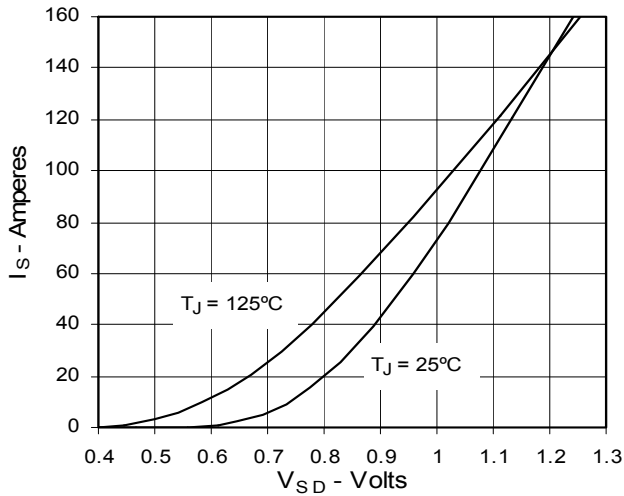
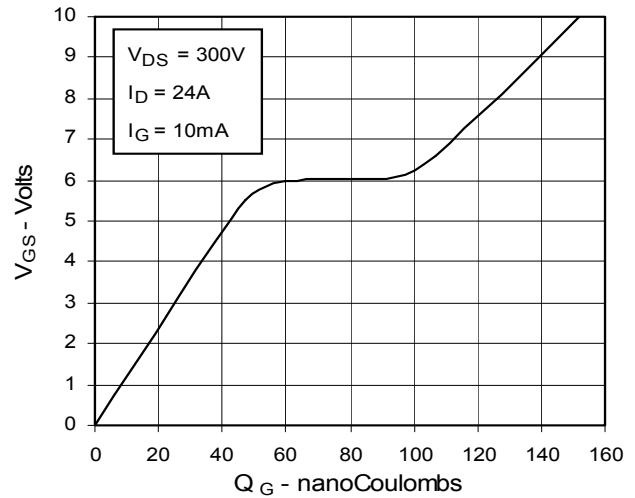
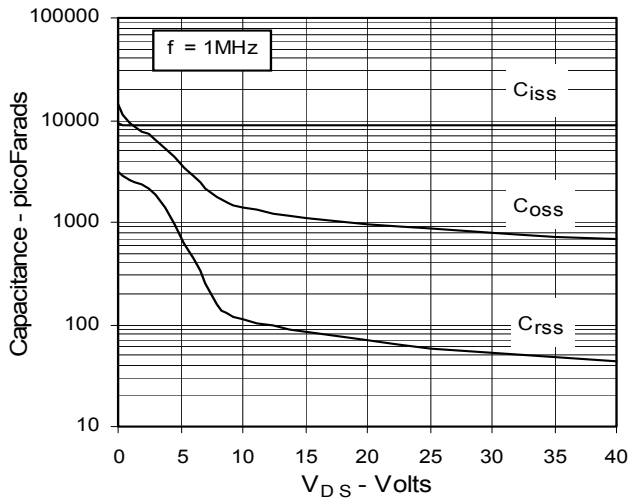
**Fig. 6. Drain Current vs. Case
Temperature**

Fig. 7. Input Admittance

Fig. 8. Transconductance

Fig. 9. Source Current vs. Source-To-Drain Voltage

Fig. 10. Gate Charge

Fig. 11. Capacitance

Fig. 13. Maximum Transient Thermal Resistance
