



## GaAs MMIC SMT PASSIVE FREQUENCY DOUBLER, 4 - 8 GHz INPUT

### Typical Applications

The HMC204C8 is suitable for:

- Wireless Local Loop
- LMDS, VSAT, and Point-to-Point Radios
- Test Equipment

### Features

- Conversion Loss: 16 dB
- Fo, 3Fo, 4Fo Isolation: 40 dB
- Passive: No Bias Required

### Functional Diagram

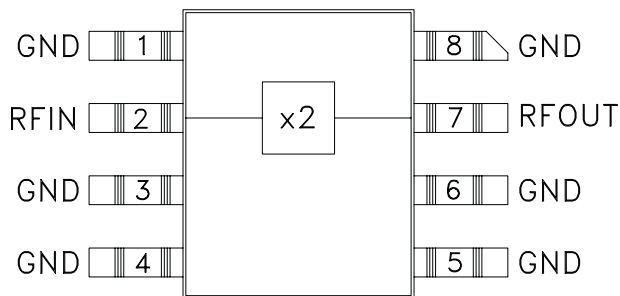

### General Description

The HMC204C8 is a passive miniature frequency doubler in a non-hermetic surface mount package. Suppression of undesired fundamental and higher order harmonics is 40 dB typical with respect to input signal level. The doubler utilizes the same GaAs Schottky diode/balun technology found in Hittite MMIC mixers. It features small size, no DC bias, and no measurable additive phase noise onto the multiplied signal.

### Electrical Specifications, $T_A = +25^\circ \text{C}$ , As a Function of Drive Level

Parameter	Input = +10 dBm			Input = +13 dBm			Input = +15 dBm			Units
	Min.	Typ.	Max.	Min.	Typ.	Max.	Min.	Typ.	Max.	
Frequency Range, Input	5.5 - 7.5			5.0 - 8.0			4.0 - 8.0			GHz
Frequency Range, Output	11.0 - 15.0			10.0 - 16.0			8.0 - 16.0			GHz
Conversion Loss		16	19		16	19		16	19	dB
FO Isolation (with respect to input level)				37	41					dB
3FO Isolation (with respect to input level)				42	46					dB
4FO Isolation (with respect to input level)				35	40					dB



**GaAs MMIC SMT PASSIVE FREQUENCY DOUBLER, 4 - 8 GHz INPUT**

**Conversion Gain vs. Temperature @ +15 dBm Drive Level**

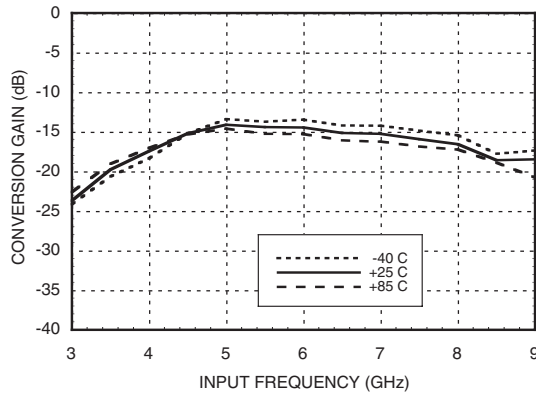

**Isolation @ +15 dBm Drive Level\***

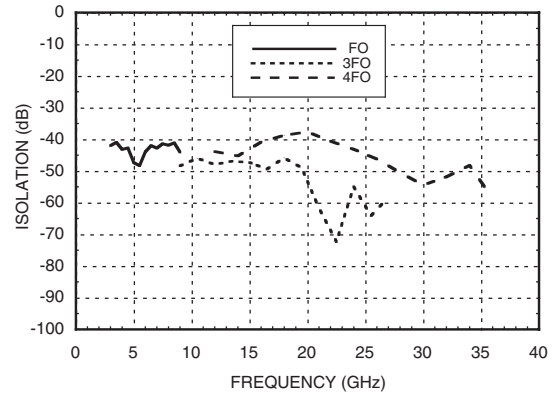

\*With respect to input level

**Input Return Loss vs. Drive Level**

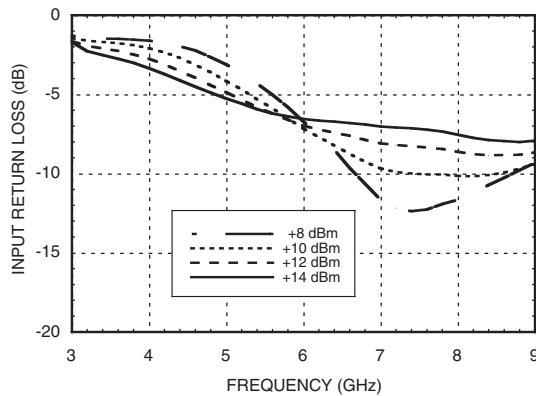

**Output Return Loss for Several Input Frequencies**

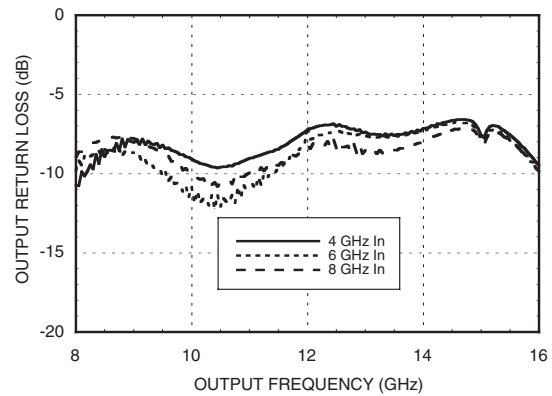

## GaAs MMIC SMT PASSIVE FREQUENCY DOUBLER, 4 - 8 GHz INPUT

**Conversion Gain @ 25 °C vs. Drive Level**

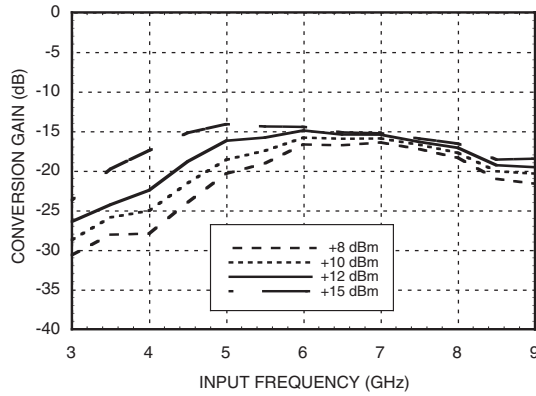

**Output Return Loss with 4 GHz Input**

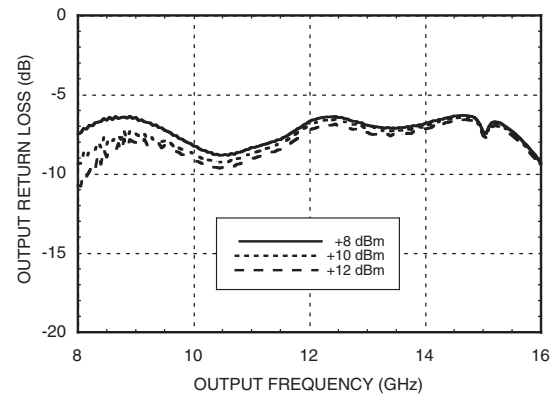

**Conversion Gain @ -40 °C vs. Drive Level**

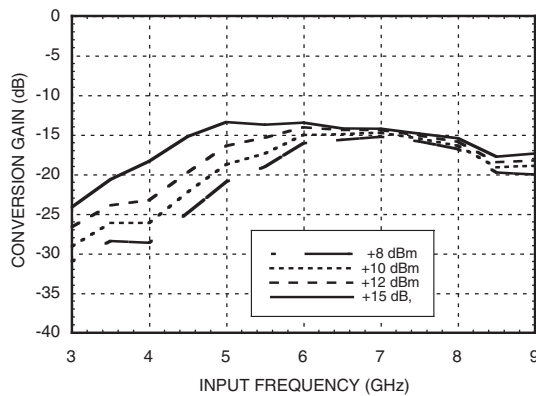

**Output Return Loss with 6 GHz Input**

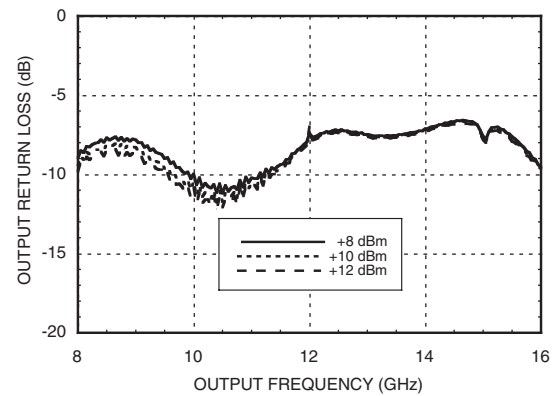

**Conversion Gain @ +85 °C vs. Drive Level**

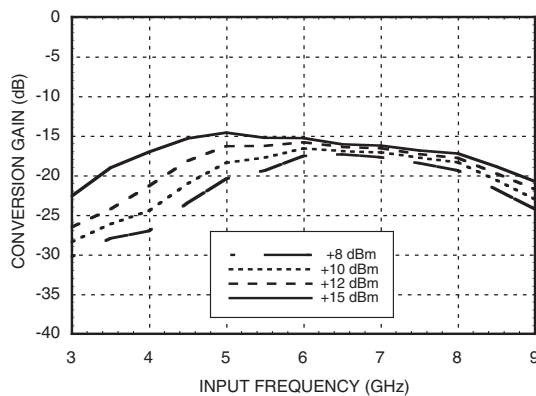

**Output Return Loss with 8 GHz Input**

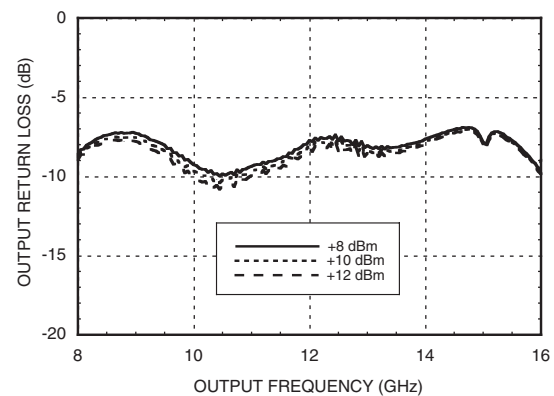



**GaAs MMIC SMT PASSIVE FREQUENCY DOUBLER, 4 - 8 GHz INPUT**

**Absolute Maximum Ratings**

Input Drive	+27 dBm
Storage Temperature	-65 to +150 °C
Operating Temperature	-40 to +85 °C



**ELECTROSTATIC SENSITIVE DEVICE  
OBSERVE HANDLING PRECAUTIONS**

**Outline Drawing**

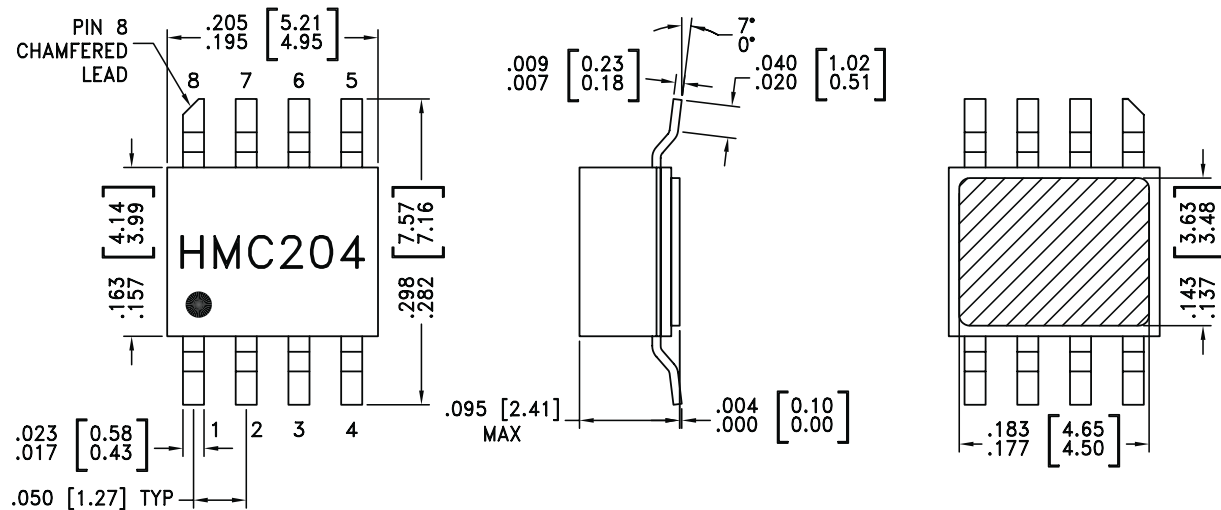

**NOTES:**

1. PACKAGE BODY MATERIAL: WHITE ALUMINA 92%
2. LEAD, PACKAGE BOTTOM MATERIAL: COPPER
3. PLATING: ELECTROLYTIC GOLD 100 - 200 MICROINCHES OVER ELECTROLYTIC NICKEL 100 TO 200 MICROINCHES.
4. DIMENSIONS ARE IN INCHES [MILLIMETERS].
5. PACKAGE LENGTH AND WIDTH DIMENSIONS DO NOT INCLUDE LID SEAL PROTRUSION .005 PER SIDE.
6. ALL GROUND LEADS AND GROUND PADDLE MUST BE SOLDERED



**GaAs MMIC SMT PASSIVE FREQUENCY DOUBLER, 4 - 8 GHz INPUT**

**Evaluation PCB**

6

FREQUENCY MULTIPLIERS - SMT

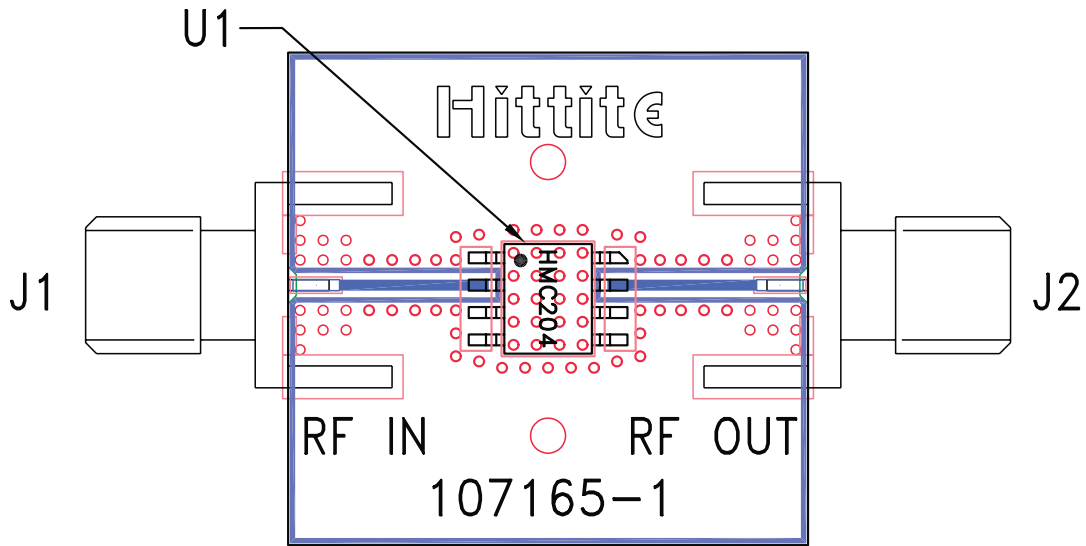

**List of Materials for Evaluation PCB 107196 [1]**

Item	Description
J1, J2	PCB Mount SMA Connector
U1	HMC204C8, Doubler
PCB [2]	107165 Eval Board

[1] Reference this number when ordering complete evaluation PCB

[2] Circuit Board Material: Rogers 4350

The circuit board used in the final application should be generated with proper RF circuit design techniques. Signal lines should have 50 ohm impedance while the package ground leads and exposed paddle should be connected directly to the ground plane similar to that shown. The evaluation circuit board shown is available from Hittite upon request.



MICROWAVE CORPORATION v04.1105



**HMC204C8**

***GaAs MMIC SMT PASSIVE FREQUENCY  
DOUBLER, 4 - 8 GHz INPUT***

**Notes:**

6

FREQUENCY MULTIPLIERS - SMT