

DIN-sized (48 x 48, 45 x 75 mm) Motor Timer with Variable Time Ranges

- Five time ranges are selectable per timer unit.
- Easy-to-monitor neon lamp for timing operation indication (for 110, 120, 220, 240 VAC types only).
- Conforms to VDE0110 Group C for creepage distance.
- Easy-to-set large transparent knob and easy-to-read single pattern scale facilitate time setting.
- Equipped with timing operation indicator and moving pointer.

RC

Ordering Information

Operation/resetting system	Internal connection	Terminal	Time-limit contact	Instantaneous contact	Model	
					Surface mounting/ track mounting	Flush mounting
Time-limit operation/ self-resetting	Separate motor and clutch connection	8-pin round socket	SPDT	SPDT	H2C-8	H2C-8 (with Y92F-30 adapter)
		11-pin round socket			H2C	H2C (with Y92F-30 adapter)
		Front screw			H2C-F	---
Time-limit operation/ electric resetting		8-pin round socket	SPDT	---	H2C-8R	H2C-8R (with Y92F-30 adapter)
		11-pin round socket			H2C-R	H2C-R (with Y92F-30 adapter)
		Front screw		H2C-FR	---	

Note: Specify both the model number and supply voltage when ordering.

■ Accessories (Order Separately)

Timer	Track mounted socket (see note 1)	Back connecting socket	
		Solder terminal	Screw terminal
H2C-8, H2C-8R	P2CF-08, PF085A	PL08	P3G-08
H2C, H2C-R	PF113A	PL11	P3GA-11





Note: Track mounted socket can be used as a front connecting socket.

Specifications

■ Time Ranges

Five time ranges are available for each timer by turning the time range selector every 60 degrees.

Note: Rated time is displayed on the window.

Time range code	Position of time range selector				
					
A	1.25 to 30 s	7.5 s to 3 min	1.25 to 30 min	7.5 min to 3 hrs	1.25 to 30 hrs
B	0.2 to 6 s	2 to 60 s	0.2 to 6 min	2 to 60 min	0.2 to 6 hrs
C	0.5 to 12 s	5 to 120 s	0.5 to 12 min	5 to 120 min	0.5 to 12 hrs

■ Ratings

Item	H2C
Rated supply voltage	100, 110, 115, 120, 200, 220, or 240 VAC (50/60 Hz) (see note 1)
Operating voltage range	85% to 110% of rated supply voltage (see note 2)
Power consumption	Approx. 3.5 VA
Control outputs	6 A at 250 VAC, resistive load ($\cos\phi = 1$) (see note 3)

Note: 1. The front panel of the timer is color coded to identify the following supply voltage classifications:

- 100 to 120 V: Blue
- 200 to 240 V: Red
- Other classes: Black

2. If the voltage continues to be applied after the set time has elapsed, the operating voltage range will change to between 90% and 110% of the rated voltage.

3. The switching capacity of the control output is 6 A at 250 VAC ($\cos\phi = 1$). Refer to "Engineering Data" since the electrical service life of the built-in switch will change in such a case.

■ Characteristics

Accuracy of operating time	$\pm 0.5\%$ max. ($\pm 1\%$ max. at 0.2 to 6 s for the time range code B or at 0.5 to 12 s for the time range code C)
Setting error	$\pm 2\%$ max.
Reset time	0.5 s max.
Influence of voltage	$\pm 1\%$ max.
Influence of temperature	$\pm 2\%$ max.
Insulation resistance	100 M Ω min. (at 500 VDC)
Dielectric strength	2,500 VAC, 50/60 Hz for 1 min (between current-carrying and non-current-carrying parts) 2,000 VAC, 50/60 Hz for 1 min (between contact and control circuit and between contacts of different polarities) 1,000 VAC, 50/60 Hz for 1 min (between non-continuous contacts)
Vibration resistance	Destruction: 10 to 55 Hz with 0.75-mm double amplitude Malfunction: 10 to 55 Hz with 0.5-mm double amplitude
Shock resistance	Destruction: 1,000 m/s ² (approx. 100G) Malfunction: 150 m/s ² (approx. 15G)
Ambient temperature	Operating: -10°C to 50°C Storage: -25°C to 65°C
Ambient humidity	Operating: 45% to 85%
Life expectancy	Mechanical: 10,000,000 operations min. 500,000 operations min. (3 A at 250 VAC, resistive load at 1,800 operations/h) Electrical: See "Engineering Data"
Motor life expectancy	20,000 hrs
Approved standards	UL (File No. E52800)
Weight	H2C series: approx. 180 g H2C-F series: approx. 270 g

Engineering Data

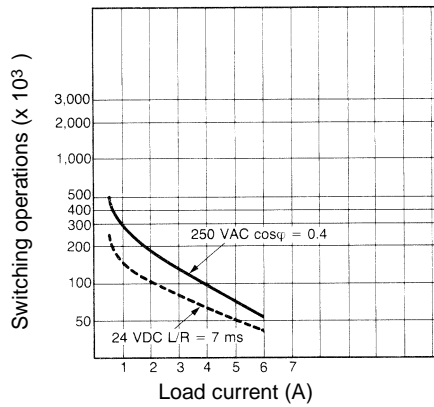
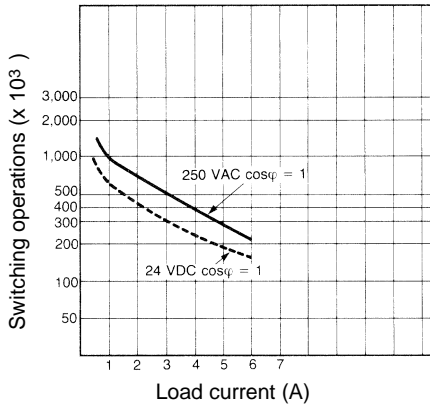

Nomenclature

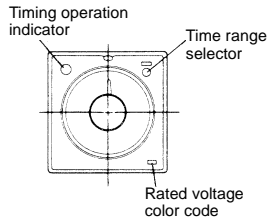

Operation

■ Timing Chart

H2C-8

ON-delay 8-pin Round Socket

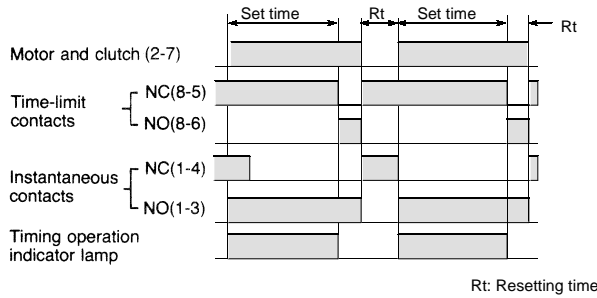

H2C-8R

OFF-delay 8-pin Round Socket

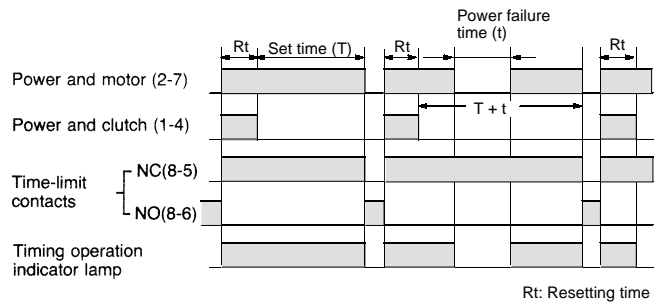

H2C(-F)

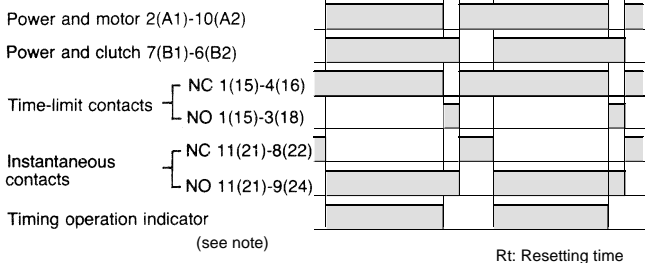

H2C(-F)R

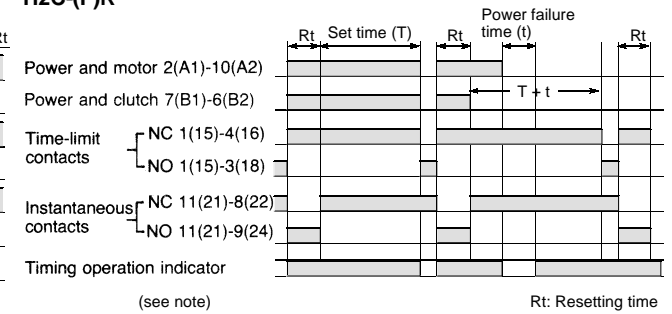

Note: For the types rated at 24 and 48 VAC, the timing operation indicator is not equipped.

Dimensions

Note: All units are in millimeters unless otherwise indicated.

H2C/H2C-R/ H2C-8/H2C-8R

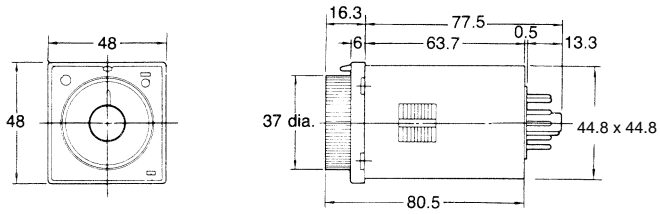

For Flush Mounting

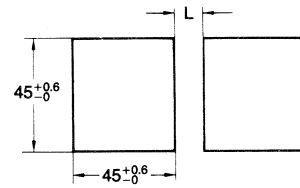

For a load current of 3 A max., dimension L becomes 3 mm min. with an interval of 0 mm between timers.
For a load current of 6 A max., dimension L becomes 8 mm min. with an interval of 5 mm between timers.

H2C-F/H2C-FR

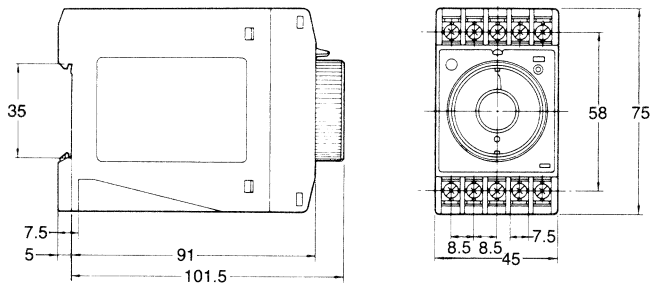

Mounting Holes

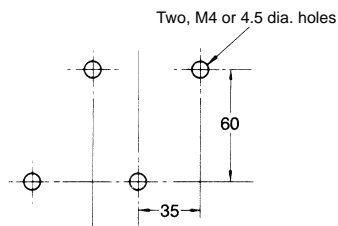

Mounting Height of Timer

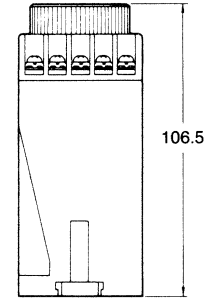

For a load current of 1 A max., dimension L becomes 10 mm min. with an interval of 0 mm between timers.
For a load current of 3 A max., dimension L becomes 15 mm min. with an interval of 5 mm between timers.
For a load current of 6 A max., dimension L becomes 20 mm min. with an interval of 10 mm between timers.

■ Accessories (Order Separately)

Track Mounted/Front Connecting Socket

P2CF-08

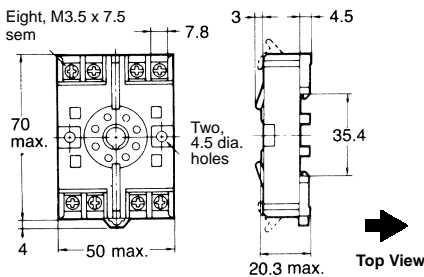

Terminal Arrangement (Top View)

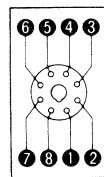

Mounting Holes

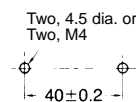

Mounting Height of Timer with Socket

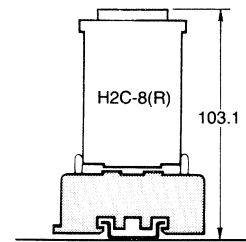

P2CF-08

PF085A

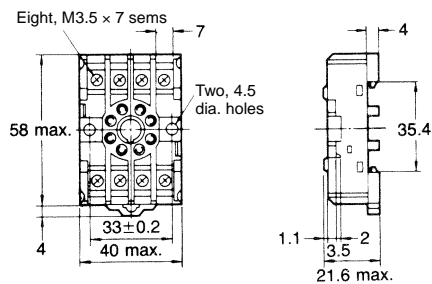

Terminal Arrangement (Top View)

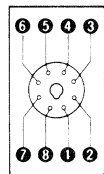

Mounting Holes

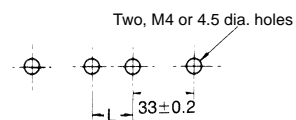

Mounting Height of Timer with Socket

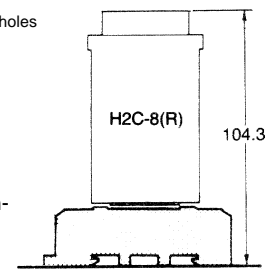

For a load current of 3 A max., dimension L becomes 14 mm min. with an interval of 0 mm between timers.
For a load current of 6 A max., dimension L becomes 19 mm min. with an interval of 5 mm between timers.

PF113A

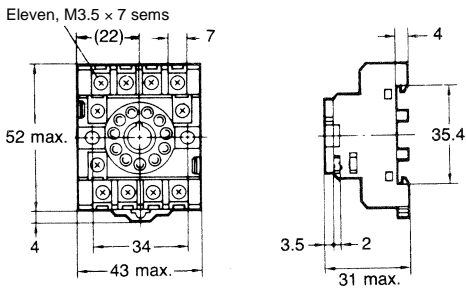

Terminal Arrangement (Top View)

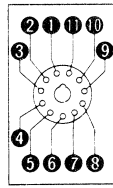

Mounting Holes

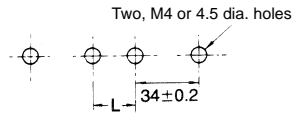

Mounting Height of Timer with Socket

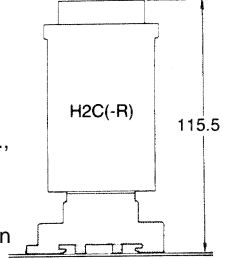

For a load current of 3 A max., dimension L becomes 14 mm min. with an interval of 0 mm between timers. For a load current of 6 A max., dimension L becomes 19 mm min. with an interval of 5 mm between timers.

Back Connecting Socket PL08 (Solder Terminals)

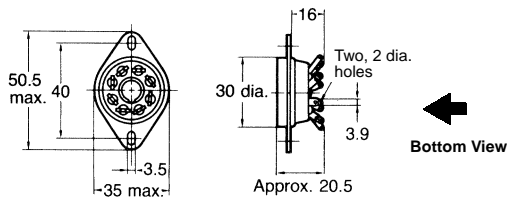

Terminal Arrangement (Bottom View)

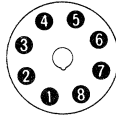

Mounting Holes

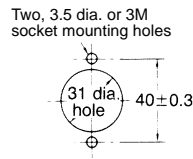

Mounting Height of Timer with Socket

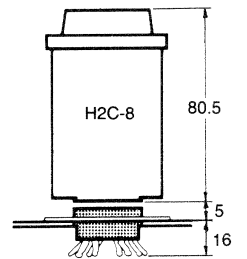

PL11 (Solder Terminals)

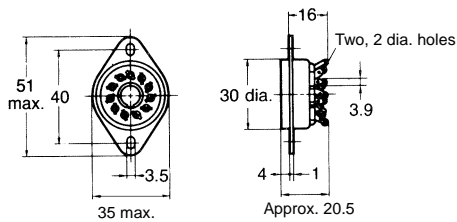

Terminal Arrangement (Bottom View)



Mounting Holes

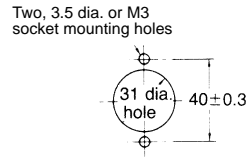

Mounting Height of Timer with Socket

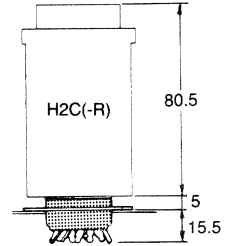

P3G-08

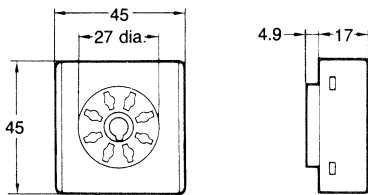

Terminal Arrangement (Bottom View)

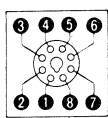

Mounting Height of Timer with Socket

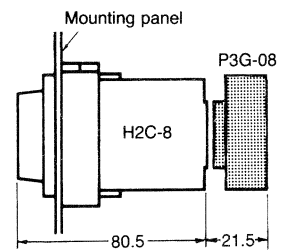

P3GA-11

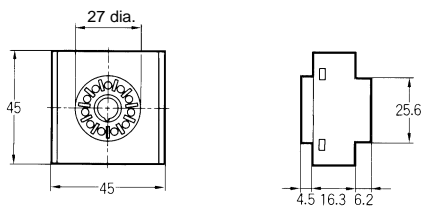

Terminal Arrangement (Bottom View)

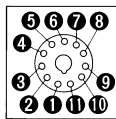

Mounting Track (Meets DIN EN50022)

PPF-100N/PPF-50N

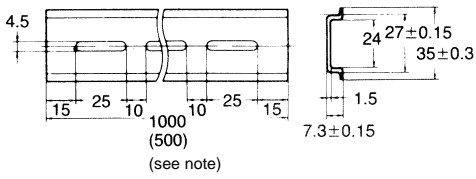

Note: This dimension applied to PPF-50N.

End Plate

PPF-M

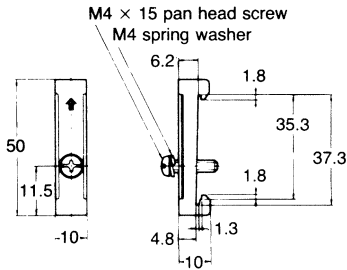

H2C (with PF113A)

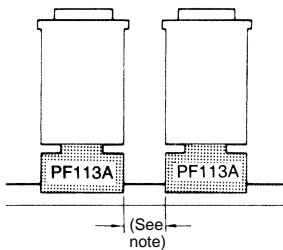

Note: For a load current of 3 A max., a spacer and an end plate are not required. For a load current of 6 A, one spacer or an end plate is required.

Adapter for Flush Mounting

Y92F-30

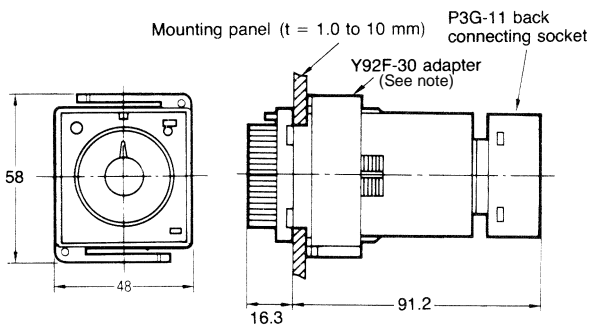

Note: The adapter can be mounted to the timer form any side of the timer housing since the adapter security notches are provided on all four sides of the housing.

PPF-100N2

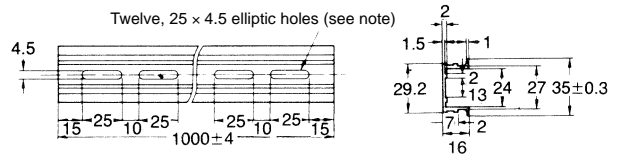

Note: A total of twelve, 25 x 4.5 elliptic holes are provided with 6 holes cut from each rail end at a pitch of 10 mm between holes.

PPF-S

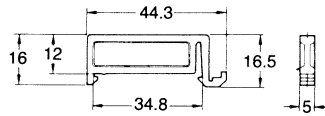

H2C-F

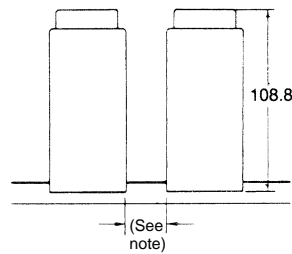

Note: For a load current of 1 A max., a spacer and an end plate are not required. For a load current of 3 A max., one spacer or an end plate is required. For a load current of 6 A max. two spacers or two end plates are required.

Timer Hold-down Clips

Y92H-2 (for PF085A/ PF113A Connecting Socket)

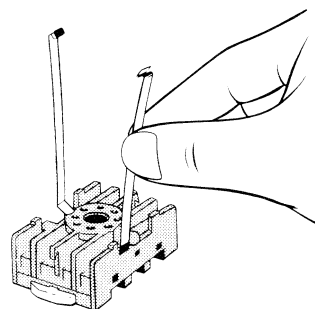

Y92H-1 (for PL08/ PL11 Connecting Socket)

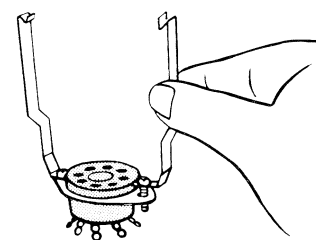

Time Setting Ring

Y92A-Y1

The time setting ring locks the time setting knob to store the set time to facilitate its resetting. A maximum of two time setting rings are connectable per timer.

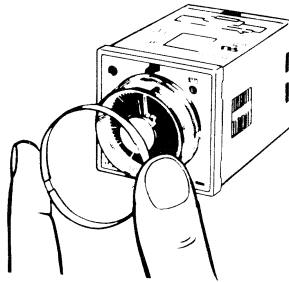

Protective Cover

Y92A-48B

The protective cover shields the front panel, particularly the time setting section, from dust, dirt, and water, as well as prevents the set value from being altered due to accidental contact with the time setting knob.

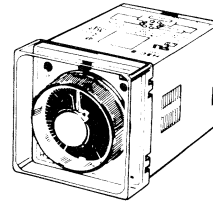

Installation

Terminal Arrangement

H2C-8

ON-delay 8-pin Round Socket

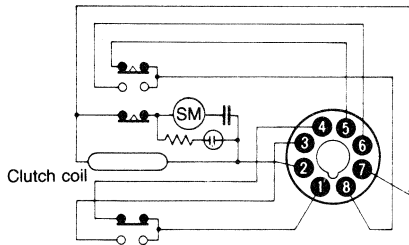

H2C-8R

OFF-delay 8-pin Round Socket

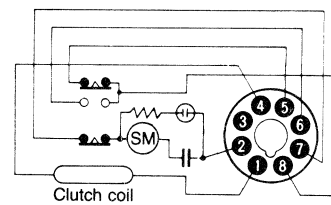

H2C(-F)

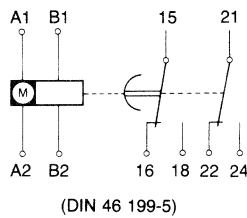
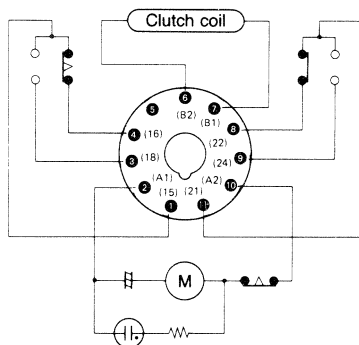

H2C(-F)R

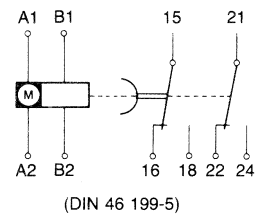
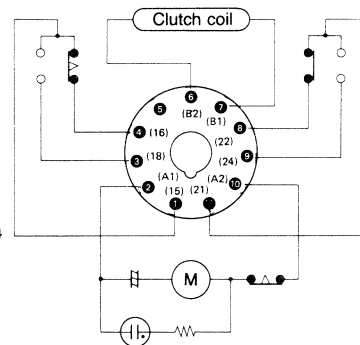

Precautions

How to Change the Time Range

Change the positions of the time range selector with a flat-blade screwdriver or an Allen wrench.

Caution

Be sure to turn the power off before changing the time specification. Changing the time range while the timer is in operation may cause a malfunction.

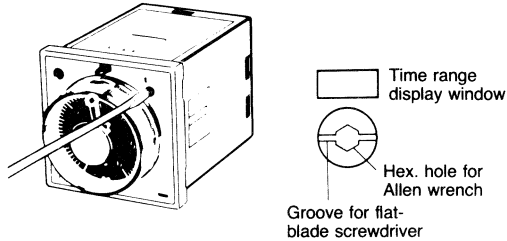

How to Select Power Frequency

Notice

Power frequency
Before using the timer, set the frequency selector located at the rear panel to the proper power frequency (50 or 60 Hz). Note that if the frequency selector is set incorrectly, time measurement may not be performed accurately against the set time.

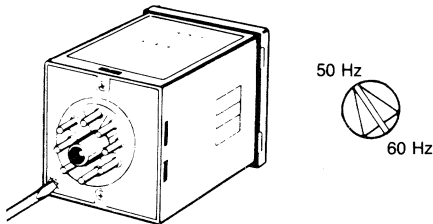

How to Mount the Timer on Mounting Track

Mounting

First hook portion A of the timer to the mounting track, then depress the timer in direction B.

Dismounting

Pull out portion C with a round-blade screwdriver and remove the timer from the mounting track.

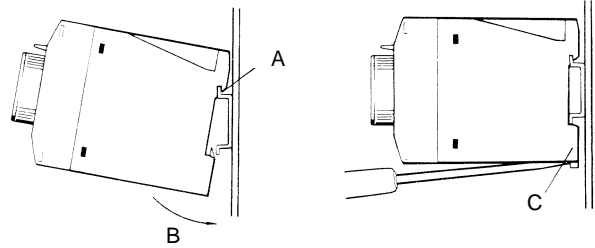

Electrical Set

The motor and clutch do not need to be reset simultaneously.

Use the voltage applied to the clutch for resetting with the H2C-R. Do not allow power to be continuously applied to the motor and clutch for extended periods of time.

Others

Do not turn the operation time setting knob beyond the range of the scale. To achieve higher accuracy in setting, measure the operation time while turning the operation time setting knob.

The deviation and setting error for the operation time shows the percent of FS. The absolute value of the deviation and setting error will not change even if the set time is changed. The time specifications should therefore be selected to use the operation time as close to FS as possible.

At high temperatures, the operation voltage will be 90% or less if voltage is applied continuously after timeout. Be sure to keep the voltage within the allowable voltage fluctuation range.

ALL DIMENSIONS SHOWN ARE IN MILLIMETERS.

To convert millimeters into inches, multiply by 0.03937. To convert grams into ounces, multiply by 0.03527.