

### GENERAL DESCRIPTION

The ADIS/EVAL is a PC-based evaluation system for all of the SPI-output iSensor™ products. It is designed to work with each product's evaluation board and comes with a Parallel Interface Board, parallel interface cable, 2 12-pin ribbon cables for evaluation board (ADIS16XXX/PCBZ) attachment, and the iSensor™ CD. The iSensor™ CD contains the iSensor Evaluation Software, along with all of the documentation for each iSensor product.

### GETTING STARTED

Getting started with this system requires four simple steps.

1. Connect J2 of the Parallel Interface Board (see Figure 1) to the appropriate power supply, using Table 1. For simplicity, Pins 1 and 4 can be tied together and Pins 2 and 3 can be tied together. Set the voltage on the power supply per Table 2.

Table 1 – Power Supply Hook-up – J2

Pin Number	Function
1	Digital I/O Power Supply
2	Common
3	Common
4	Sensor Power Supply

NOTE: No reverse polarity protection provided.

Table 2- Power Supply Voltages

Evaluation Board	Power Supply Voltage
ADIS16003/PCBZ	+3.0 to +5.25V
ADIS16006/PCBZ	+3.0 to +5.25V
ADIS16080/PCBZ	+4.75 to +5.25V
ADIS16100/PCB	+4.75 to +5.25V
ADIS16201/PCBZ	+3.0 to +3.6V
ADIS16203/PCBZ	+3.0 to +3.6V
ADIS16250/PCBZ	+4.75 to +5.25V

2. Using Figure 2 as a guide, install the appropriate ADIS16XXX/PCBZ evaluation board on the Parallel Interface Board. Four 2mm mounting holes are provided for secure mechanical attachment and the 2 12-pin ribbon cables are for the necessary electrical connections. These cables are already installed on J3 and J4 of the Parallel Interface Board and need to be connected to J1 and J2 of the ADIS16XXX/PCBZ. Make sure that these cables are seated correctly on each header. Misalignment can result in damage to the sensor.
3. Hook up the system to a PC using the parallel cable provided.
4. Place the iSensor™ CD into the PC's CD drive and review the ReadMeFirst.PDF file. Then install the software per the instructions in this file.

### SOFTWARE OPERATION

The iSensor™ Evaluation Software installation will provide options for evaluating a number of products. Using the Windows Start button, select Programs, then select Analog Devices iSensor™, then select the product that is being evaluated. The first time the software is started, the interface will need to be set up per the ReadMeFirst.PDF file.

The software contains help files that describe each function of the software. The right button on the mouse has the ability to speed up changes when the Pointer is placed over titles, graph axes and waveform data.

See Figure 4 (ADIS16003, ADIS16006), Figure 5 (ADIS16080, ADIS16100), Figure 6 (ADIS16201), Figure 7 (ADIS16203), and Figure 8 (ADIS16250) for basic software assistance.

### ORDERING GUIDE

Model	Package Description
ADISEVAL	iSensor™ PC Evaluation System

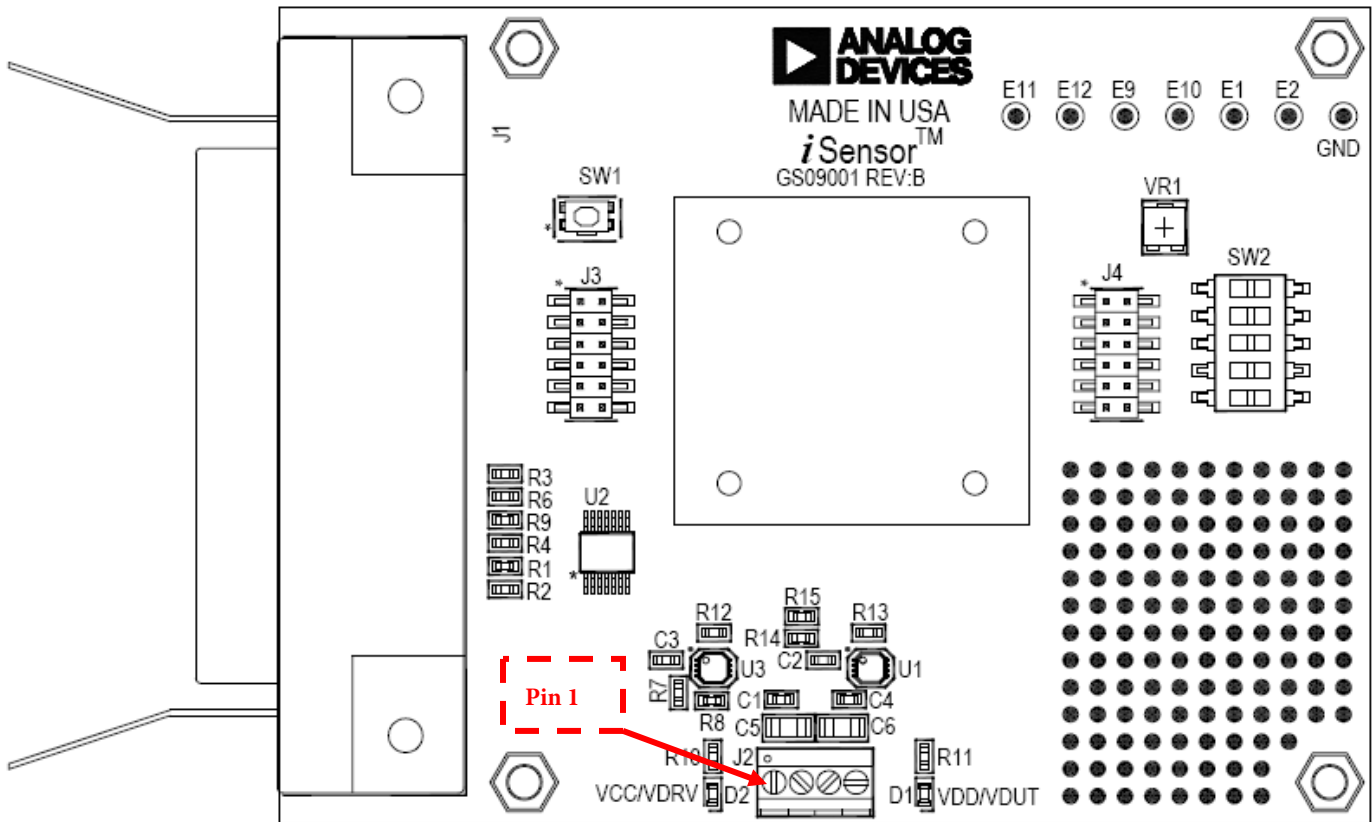

DO NOT INSTALL U1, U3, R7, R8, R14 AND R15.

Figure 1 – iSensor™ PC Interface Board Layout

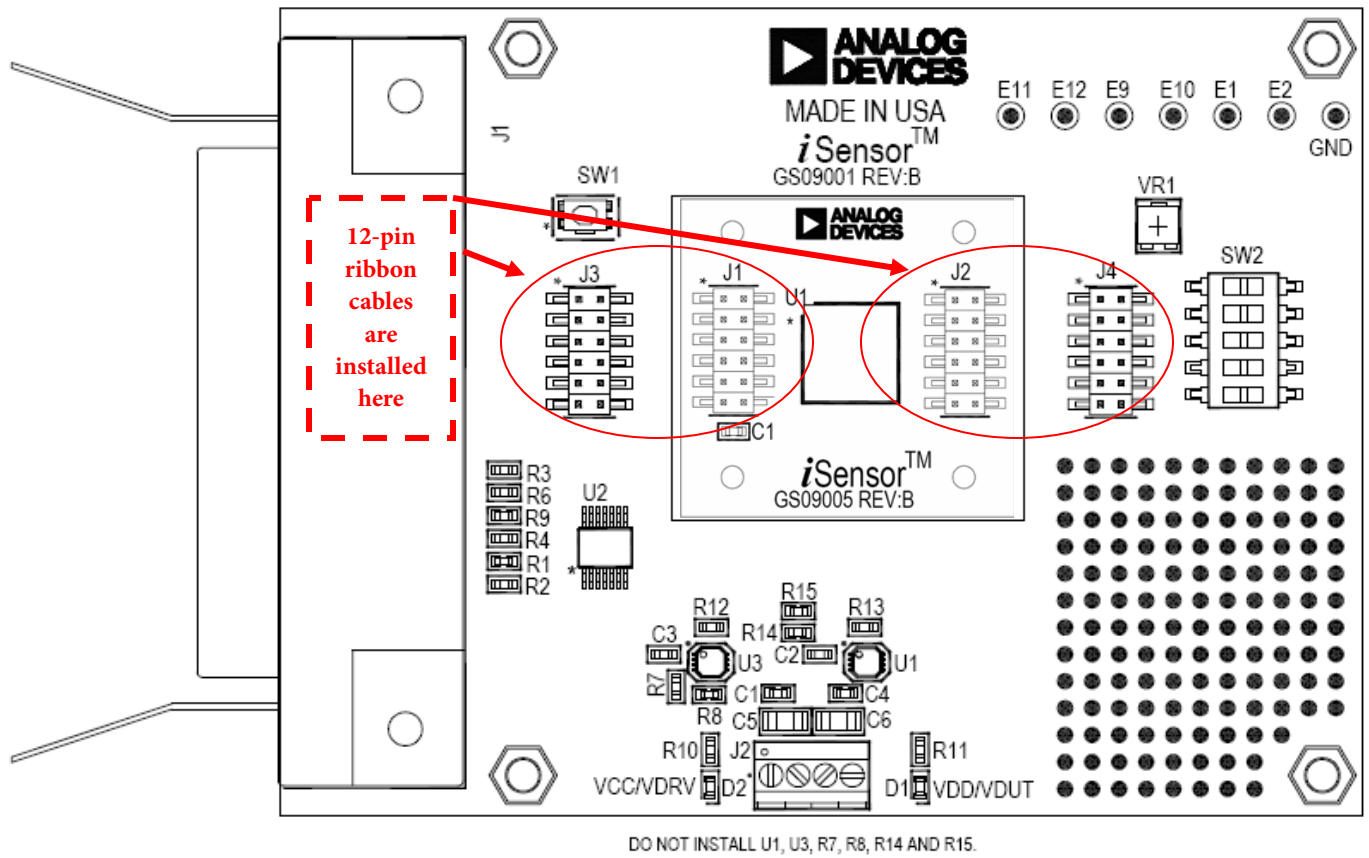

Figure 2 – iSensor™ PC Interface Board with ADIS16201/PCBZ installed



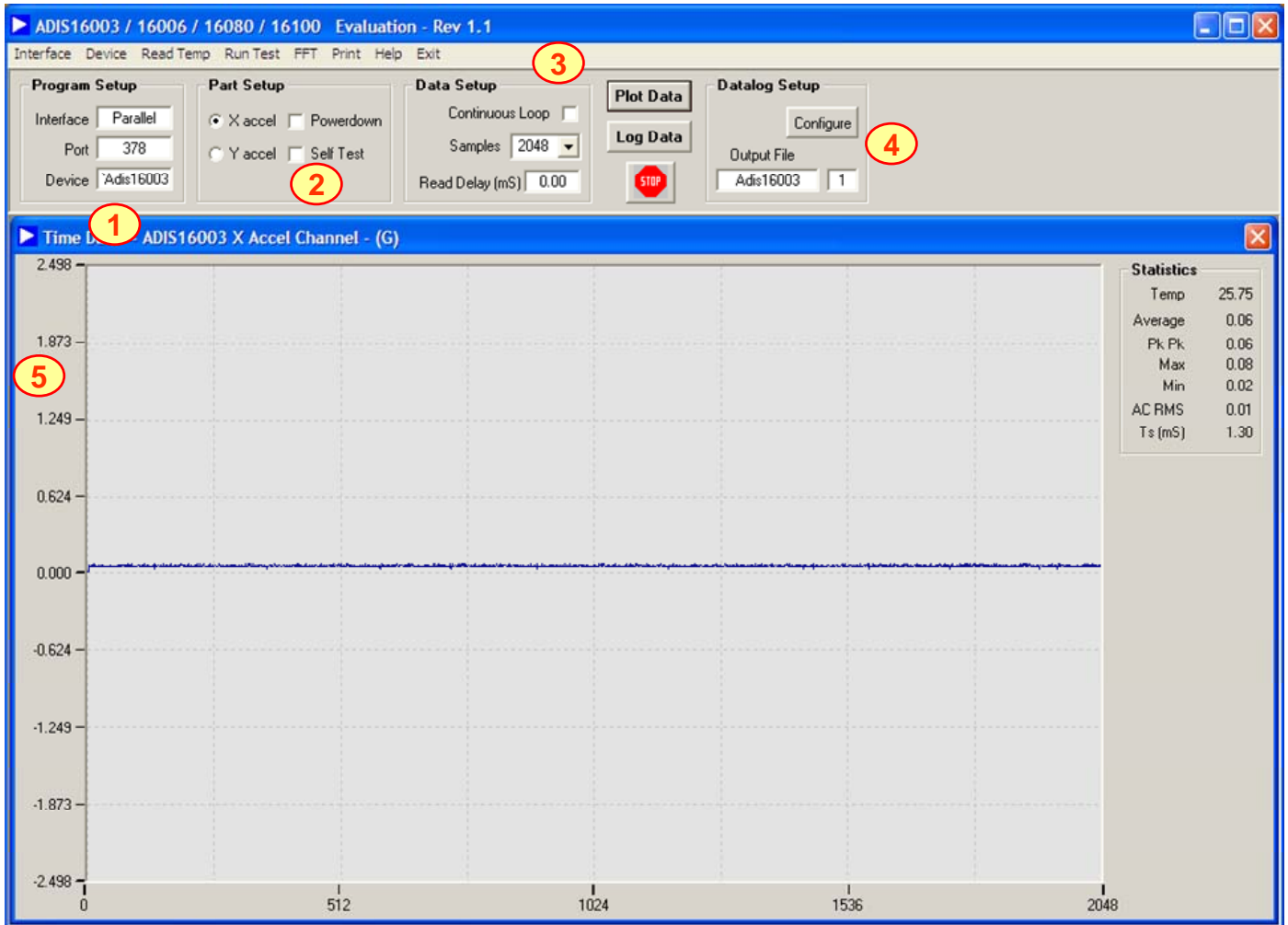
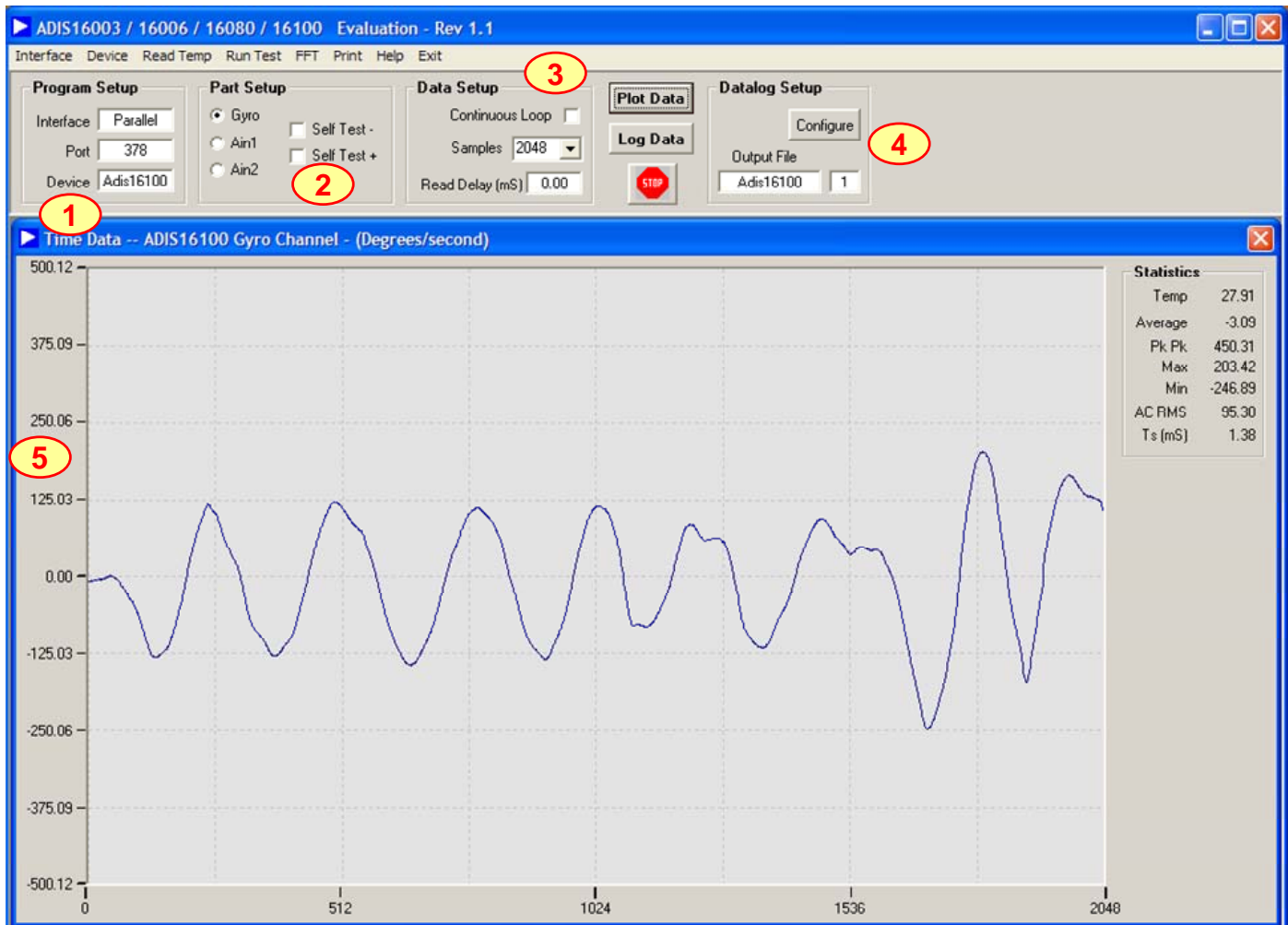

FIGURE FLAG NOTES:

1. Set the Device type to ADIS16003 or ADIS16006. Set the Interface to parallel and set the port address per ReadMeFirst.PDF
2. Set the axis being tested. Test function exercises a self-test during a single sweep on the screen.
3. Plot and log data to files.
4. Set up data logging parameters.
5. Right click over Y-Axis to adjust scale and offset of the plot.

Figure 4. ADIS16003 and ADIS16006 Evaluation Software



## FIGURE FLAG NOTES:

1. Set the Device type to ADIS16080 or ADIS16100. Set the Interface to parallel and set the port address per ReadMeFirst.PDF
2. Set the output channel being tested. Test function exercises a self-test during a single sweep on the screen.
3. Plot and log data to files.
4. Set up data logging parameters.
5. Right click over Y-Axis to adjust scale and offset of the plot.

Figure 5. ADIS16080 and ADIS16100 Evaluation Software

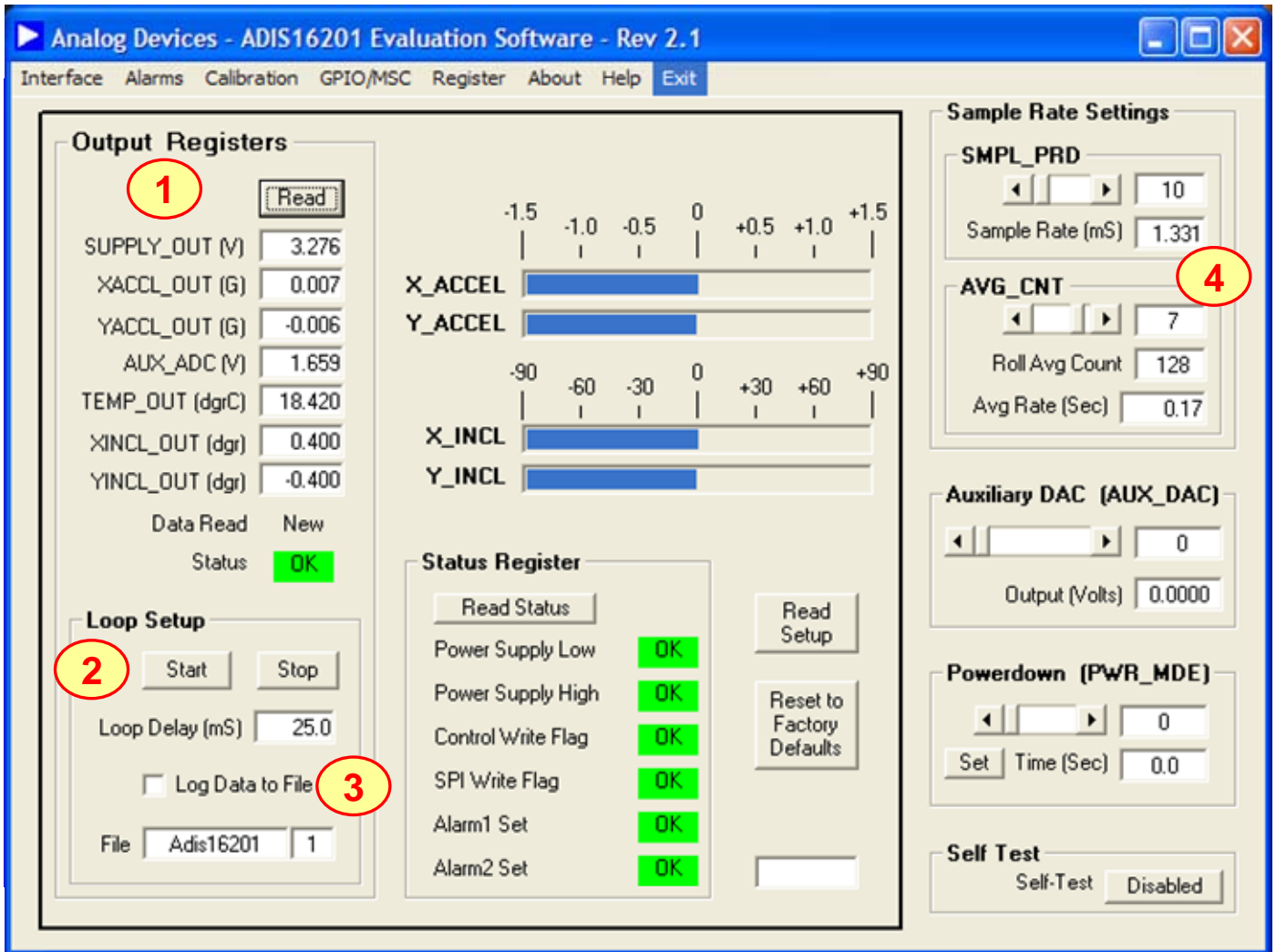
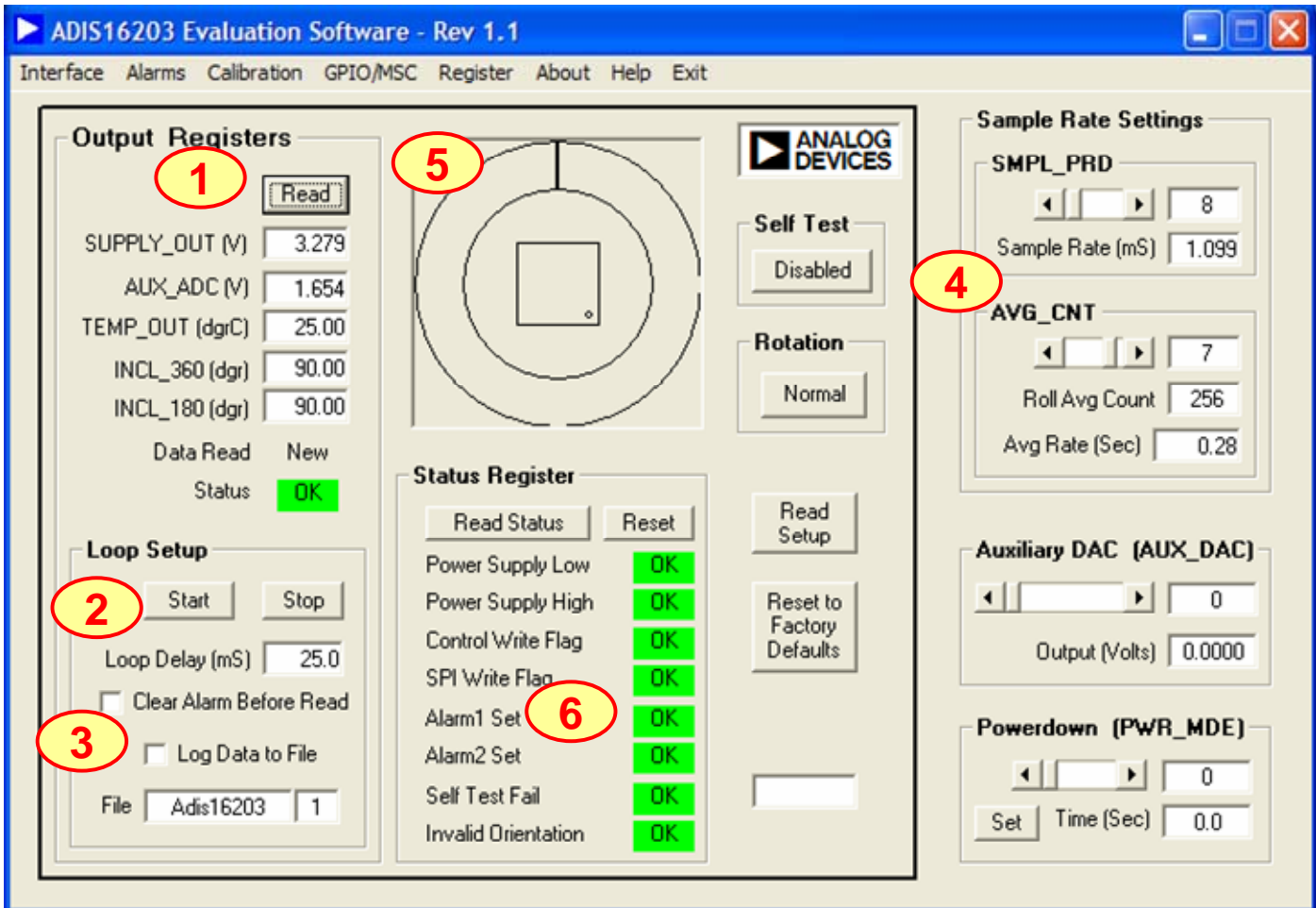

FIGURE FLAG NOTES:

1. Perform a single read of the ADIS16201’s output data
2. Start and stop continuous reading of the ADIS16201’s output data. Set the acquisition loop delay time. This provides rough control over sample times. Please note that this data will not have a high degree of coherence.
3. Select the file data logging option.
4. Configure the ADIS16201’s internal sample rate and filter response.

Figure 6. ADIS16201 Evaluation Software



## FIGURE FLAG NOTES:

1. Perform a single read of the ADIS16203's output data
2. Start and stop continuous reading of the ADIS16203's output data. Set the acquisition loop delay time. This provides rough control over sample times. Please note that this data will not have a high degree of coherence.
3. Select the file data logging option.
4. Configure the ADIS16203's internal sample rate and filter response.
5. Graphical orientation. Note that for incline angle - 0°, the corner dot would be in the lower, left hand corner.
6. Alarm monitoring. Note that these turn red on alarm condition. They maintain their status until the Reset button is pressed, even if the error condition has cleared.

Figure 7. ADIS16203 Evaluation Software



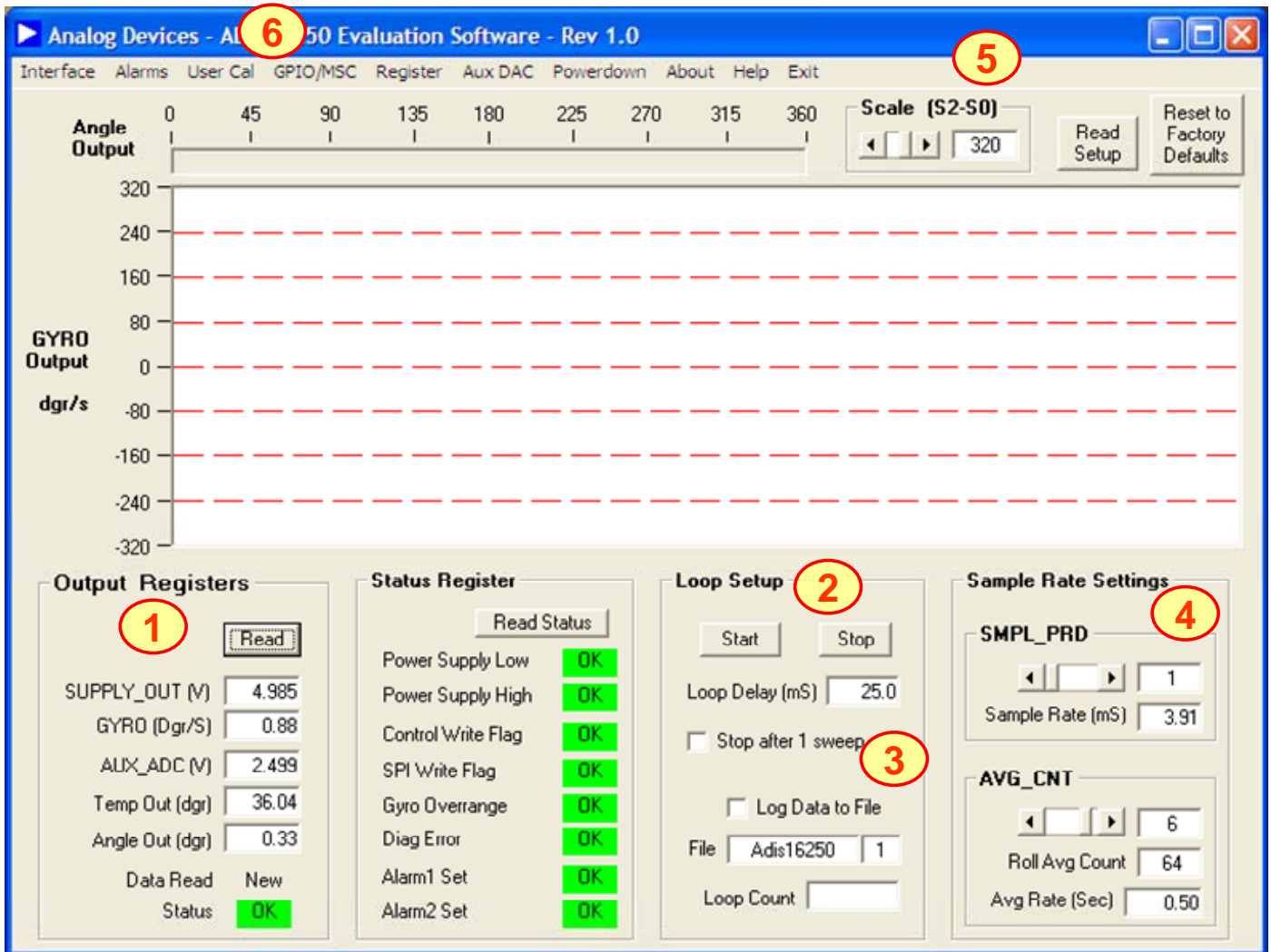

FIGURE FLAG NOTES:

1. Perform a single read of the ADIS16250's output data
2. Start and stop continuous reading of the ADIS16250's output data. Set the acquisition loop delay time. This provides rough control over sample times. Please note that this data will not have a high degree of coherence.
3. Select the file data logging option.
4. Configure the ADIS16201's internal sample rate and filter response.
5. Set the measurement range from the three options available in the ADIS16250.
6. Exercise the user calibration functions.

Figure 8. ADIS16250 Evaluation Software